

Instruction Manual

RESIDENTIAL GAS WATER HEATERS

POWER VENTED GAS MODELS WITH HOT SURFACE IGNITION
NOT FOR USE IN MANUFACTURED (MOBILE) HOMES

GAS-FIRED



LISTED



GAMA certification applies to all residential gas water heaters with capacities of 20 to 100 gallons with input rating of 75,000 BTU/Hr. or less.

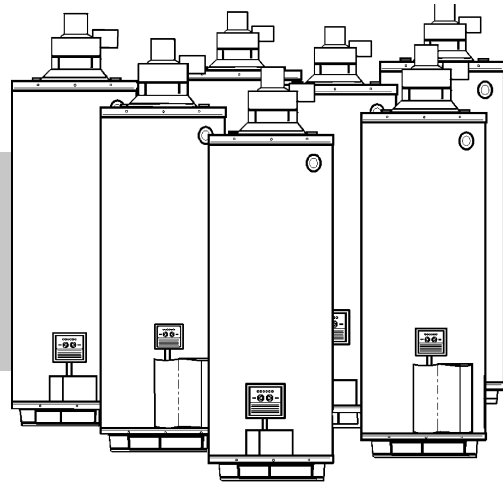

WARNING: If the information in these instructions is not followed exactly, a fire or explosion may result causing property damage, personal injury or death.

— Do not store or use gasoline or other flammable vapors and liquids in the vicinity of this or any other appliance.

— **WHAT TO DO IF YOU SMELL GAS:**

- Do not try to light any appliance.
- Do not touch any electrical switch; do not use any phone in your building.
- Immediately call your gas supplier from a neighbor's phone. Follow the gas supplier's instructions.
- If you cannot reach your gas supplier, call the fire department.

— Installation and service must be performed by a qualified installer, service agency or the gas supplier.

WARNING

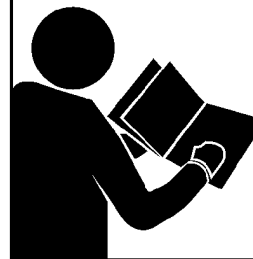

Read and understand instruction manual and safety messages before installing, operating or servicing this water heater.

Failure to follow instructions and safety messages could result in death or serious injury.

Instruction manual must remain with water heater.

• For Your Safety •

AN ODORANT IS ADDED TO THE GAS USED BY THIS WATER HEATER.





ALL TECHNICAL AND WARRANTY QUESTIONS: SHOULD BE DIRECTED TO THE LOCAL DEALER FROM WHOM THE WATER HEATER WAS PURCHASED. IF YOU ARE UNSUCCESSFUL, PLEASE WRITE TO THE COMPANY LISTED ON THE RATING PLATE ON THE WATER HEATER.

**KEEP THIS MANUAL IN THE POCKET ON HEATER FOR FUTURE REFERENCE
WHENEVER MAINTENANCE ADJUSTMENT OR SERVICE IS REQUIRED.**

SAFE INSTALLATION, USE AND SERVICE

Your safety and the safety of others is extremely important in the installation, use and servicing of this water heater.

Many safety-related messages and instructions have been provided in this manual and on your own water heater to warn you and others of a potential injury hazard. Read and obey all safety messages and instructions throughout this manual. It is very important that the meaning of each safety message is understood by you and others who install, use or service this water heater.

	This is the safety alert symbol. It is used to alert you to potential personal injury hazards. Obey all safety messages that follow this symbol to avoid possible injury or death.
 DANGER	DANGER indicates an imminently hazardous situation which, if not avoided, will result in death or injury.
 WARNING	WARNING indicates a potentially hazardous situation which, if not avoided, could result in death or injury.
 CAUTION	CAUTION indicates a potentially hazardous situation which, if not avoided, could result in minor or moderate injury.
CAUTION	CAUTION used without the safety alert symbol indicates a potentially hazardous situation which, if not avoided, could result in property damage

All safety messages will generally tell you about the type of hazard, what can happen if you do not follow the safety message and how to avoid the risk of injury.

The California Safe Drinking Water and Toxic Enforcement Act requires the Governor of California to publish a list of substances known to the State of California to cause cancer, birth defects, or other reproductive harm, and requires businesses to warn of potential exposure to such substances.

WARNING: This product contains a chemical known to the State of California to cause cancer, birth defects, or other reproductive harm. This appliance can cause low-level exposure to some of the substances included in the Act.

IMPORTANT DEFINITIONS

- **Qualified Installer:** A qualified installer must have ability equivalent to a licensed tradesman in the fields of plumbing, air supply, venting and gas supply, including a thorough understanding of the requirements of the National Fuel Gas Code as it relates to the installation of gas fired water heaters. The qualified installer must also be familiar with the design features and use of flammable vapor ignition resistant water heaters, and have a thorough understanding of this instruction manual.
- **Service Agency:** A service agency also must have ability equivalent to a licensed tradesman in the fields of plumbing, air supply, venting and gas supply, including a thorough understanding of the requirements of the National Fuel Gas Code as it relates to the installation of gas fired water heaters. The service agency must also have a thorough understanding of this instruction manual, and be able to perform repairs strictly in accordance with the service guidelines provided by the manufacturer.
- **Gas Supplier:** The Natural Gas or Propane Utility or service who supplies gas for utilization by the gas burning appliances within this application. The gas supplier typically has responsibility for the inspection and code approval of gas piping up to and including the Natural Gas meter or Propane storage tank of a building. Many gas suppliers also offer service and inspection of appliances within the building.

GENERAL SAFETY

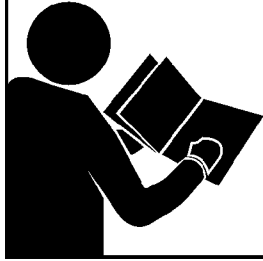

⚠ WARNING

Read and understand instruction manual and safety messages before installing, operating or servicing this water heater.

Failure to follow instructions and safety messages could result in death or serious injury.

Instruction manual must remain with water heater.



⚠ WARNING

Fire Hazard

For continued protection against risk of fire:

- Do not install water heater on carpeted floor.
- Do not operate water heater if flood damaged.

⚠ DANGER

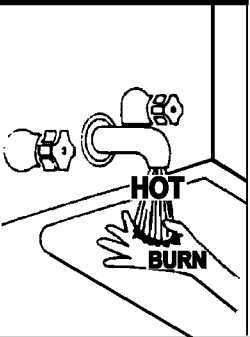

Water temperature over 125°F (52°C) can cause severe burns instantly resulting in severe injury or death.

Children, the elderly, and the physically or mentally disabled are at highest risk for scald injury.

Feel water before bathing or showering.

Temperature limiting valves are available.

Read instruction manual for safe temperature setting.

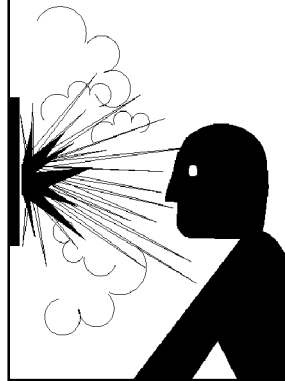

⚠ WARNING

Explosion Hazard

- Overheated water can cause water tank explosion.
- Properly sized temperature and pressure relief valve must be installed in opening provided.

⚠ WARNING

Fire or Explosion Hazard

- Do not store or use gasoline or other flammable vapors and liquids in the vicinity of this or any other appliance.
- Avoid all ignition sources if you smell LP gas.
- Do not expose water heater control to excessive gas pressure.
- Use only gas shown on rating plate.
- Maintain required clearances to combustibles.
- Keep ignition sources away from faucets after extended period of non-use.



Read instruction manual before installing, using or servicing water heater.



⚠ WARNING

Breathing Hazard - Carbon Monoxide Gas

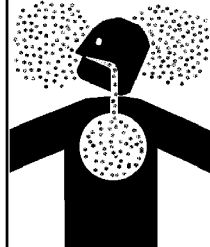

- Install vent system in accordance with codes.
- Do not operate water heater if flood damaged.
- High altitude orifice must be installed for operation above 7,700 feet.
- Do not operate if suit buildup.
- Do not obstruct water heater air intake with insulating jacket.
- Do not place chemical vapor emitting products near water heater.
- Gas and carbon monoxide detectors are available.
- No vent damper installation is compatible with this power vented water heater.

Breathing carbon monoxide can cause brain damage or death. Always read and understand instruction manual.

CAUTION

Improper installation and use may result in property damage.

- Do not operate water heater if flood damaged.
- Inspect and replace anode.
- Install in location with drainage.
- Fill tank with water before operation.
- Be alert for thermal expansion.

Refer to instruction manual for installation and service.



⚠ WARNING

- Before servicing the water heater, make sure the blower assembly is unplugged or the electrical supply to the water heater is turned "OFF".
- Label all wires prior to disconnection when servicing controls. Wiring error can cause improper and dangerous operation. Verify proper operation after servicing.
- Failure to do this could result in death, serious bodily injury, or property damage.

TABLE OF CONTENTS

SAFE INSTALLATION, USE AND SERVICE.....	2	FOR YOUR INFORMATION.....	23
GENERAL SAFETY.....	3	Start Up Conditions.....	23
TABLE OF CONTENTS.....	4	Condensate.....	23
INTRODUCTION.....	4	Smoke/Odor.....	23
Preparing for the New Installation.....	4	Thermal Expansion.....	23
INSTALLATION REQUIREMENTS FOR THE COMMONWEALTH OF MASSACHUSETTS.....	5	Strange Sounds.....	23
TYPICAL INSTALLATION.....	6-7	Operational Conditions.....	23
LOCATING THE NEW WATER HEATER.....	8-10	Smelly Water.....	23
Facts to Consider About Location.....	8-9	“Air” in Hot Water Faucets.....	23
Insulation Blankets.....	9	High Temperature Shut Off System.....	23
Combustion Air and Ventilation for Appliances Located in Unconfined Spaces.....	9	PERIODIC MAINTENANCE.....	24
Combustion Air and Ventilation for Appliances Located in Confined Spaces.....	9-10	Venting System Inspection.....	24
INSTALLING THE WATER HEATER.....	11-21	Burner Inspection.....	24
Water Piping.....	11-12	Burner Cleaning.....	24
Temperature-Pressure Relief Valve.....	12	Housekeeping.....	24-25
Gas Piping.....	13	Anode Rod Inspection.....	25
Sediment Traps.....	14	Temperature-Pressure Relief Valve Operation.....	25
Blower Assembly Installation.....	15	Draining.....	25
Vent Pipe Connection to Blower Assembly.....	16	Drain Valve Washer Replacement.....	25-26
Venting and Installation.....	16-17	Service.....	26
LIGHTING & OPERATING LABEL.....	21	LEAKAGE CHECKPOINTS.....	26
TEMPERATURE REGULATION.....	22	REPAIR PARTS.....	27
		TROUBLESHOOTING.....	28-30
		WARRANTY.....	31

INTRODUCTION

Thank You for purchasing this water heater. Properly installed and maintained, it should give you years of trouble free service.

Abbreviations Found In This Instruction Manual:

- CSA - Canadian Standards Association
- ANSI - American National Standards Institute
- NFPA - National Fire Protection Association
- ASME - American Society of Mechanical Engineers
- GAMA - Gas Appliance Manufacturer's Association
- UL - Underwriters Laboratories Inc.

This gas-fired water heater is design certified by Underwriters Laboratories Inc. under American National Standard/CSA Standard for Gas Water Heaters ANSI Z21.10.1 • CSA 4.1 (current edition).

PREPARING FOR THE INSTALLATION

1. Read the “General Safety” section, page 3 of this manual first and then the entire manual carefully. If you don't follow the safety rules, the water heater will not operate properly. It could cause DEATH, SERIOUS BODILY INJURY AND/OR PROPERTY DAMAGE.

This manual contains instructions for the installation, operation, and maintenance of the gas-fired water heater. It also contains warnings throughout the manual that you must read and be aware of. All warnings and all instructions are essential to the proper operation of the water heater and your safety. Since we cannot put everything on the first few pages, **READ THE ENTIRE MANUAL BEFORE ATTEMPTING TO INSTALL OR OPERATE THE WATER HEATER.**

2. The installation must conform with these instructions and the local code authority having jurisdiction. In the absence of local codes, installations shall comply with the National Fuel Gas Code ANSI Z223.1/NFPA 54 and the National Electrical Code, NFPA 70. These publications are available from The National Fire Protection Association, 1 Batterymarch Park, Quincy, MA 02269.
3. The water heater when installed must be grounded in accordance with the local codes, or in the absence of local codes: In the United States, the National Electrical Code. ANSI/NFPA 70 (current edition).
4. If after reading this manual you have any questions or do not understand any portion of the instructions, call the local gas utility or the manufacturer whose name appears on the rating plate.
5. Carefully plan the place where you are going to put the water heater. Correct combustion, vent action, and vent pipe installation are very important in preventing death from possible carbon monoxide poisoning and fires, see Figures 1 and 2.

Examine the location to ensure the water heater complies with the “Locating the New Water Heater” section in this manual.

6. For California installation this water heater must be braced, anchored, or strapped to avoid falling or moving during an earthquake. See instructions for correct installation procedures. Instructions may be obtained from California Office of the State Architect, 400 P Street, Sacramento, CA 95814.
7. Massachusetts Code requires this water heater to be installed in accordance with Massachusetts 248-CMR 2.00: State Plumbing Code and 248-CMR 5.00. For more information see next page.
8. Complies with SCAQMD rule #1121 and districts having equivalent NOx requirements.

INSTALLATION REQUIREMENTS FOR THE COMMONWEALTH OF MASSACHUSETTS

For all side wall terminated, horizontally vented power vent, direct vent, and power direct vent gas fueled water heaters installed in every dwelling, building or structure used in whole or in part for residential purposes, including those owned or operated by the Commonwealth and where the side wall exhaust vent termination is less than seven (7) feet above finished grade in the area of the venting, including but not limited to decks and porches, the following requirements shall be satisfied:

INSTALLATION OF CARBON MONOXIDE DETECTORS At the time of installation of the side wall horizontal vented gas fueled equipment, the installing plumber or gasfitter shall observe that a hard wired carbon monoxide detector with an alarm and battery back-up is installed on the floor level where the gas equipment is to be installed. In addition, the installing plumber or gasfitter shall observe that a battery operated or hard wired carbon monoxide detector with an alarm is installed on each additional level of the dwelling, building or structure served by the sidewall horizontal vented gas fueled equipment. It shall be the responsibility of the property owner to secure the services of qualified licensed professionals for the installation of hard wired carbon monoxide detectors.

In the event that the side wall horizontally vented gas fueled equipment is installed in a crawl space or an attic, the hard wired carbon monoxide detector with alarm and battery back-up may be installed on the next adjacent floor level.

In the event that the requirements of this subdivision can not be met at the time of completion of installation, the owner shall have a period of thirty (30) days to comply with the above requirements provided that during said thirty (30) day period, a battery operated carbon monoxide detector with an alarm shall be installed.

APPROVED CARBON MONOXIDE DETECTORS Each carbon monoxide detector as required in accordance with the above provisions shall comply with NFPA 720 and be ANSI/UL 2034 listed and CSA certified.

SIGNAGE A metal or plastic identification plate shall be permanently mounted to the exterior of the building at a minimum height of eight (8) feet above grade directly in line with the exhaust vent terminal for the horizontally vented gas fueled heating appliance or equipment. The sign shall read, in print size no less than one-half (1/2) inch in size, "**GAS VENT DIRECTLY BELOW. KEEP CLEAR OF ALL OBSTRUCTIONS.**"

INSPECTION The state or local gas inspector of the side wall horizontally vented gas fueled equipment shall not approve the installation unless, upon inspection, the inspector observes carbon monoxide detectors and signage installed in accordance with the provisions of 248 CMR 5.08(2)(a) 1 through 4.

EXEMPTIONS: The following equipment is exempt from 248 CMR 5.08(2)(a)1 through 4:

1. The equipment listed in Chapter 10 entitled "Equipment Not Required To Be Vented" in the most current edition of NFPA 54 as adopted by the Board; and
2. Product Approved side wall horizontally vented gas fueled equipment installed in a room or structure separate from the dwelling, building, or structure used in whole or in part for residential purposes.

MANUFACTURER REQUIREMENTS - GAS EQUIPMENT VENTING SYSTEM PROVIDED When the manufacturer of Product Approved side wall horizontally vented gas equipment provides a venting system design or venting system components with the equipment, the instructions provided by the manufacturer for installation of the equipment and the venting system shall include:

1. Detailed instructions for the installation of the venting system design or the venting system components; and
2. A complete parts list for the venting system design or venting system.

MANUFACTURER REQUIREMENTS - GAS EQUIPMENT VENTING SYSTEM NOT PROVIDED When the manufacturer of a Product Approved side wall horizontally vented gas fueled equipment does not provide the parts for venting the flue gases, but identifies "special venting systems," the following requirements shall be satisfied by the manufacturer:

1. The referenced "special venting system" instructions shall be included with the appliance or equipment installation instructions; and
2. The "special venting systems" shall be Product Approved by the Board, and the instructions for that system shall include a parts list and detailed installation instructions.

A copy of all installation instructions for all Product Approved side wall horizontally vented gas fueled equipment, all venting instructions, all parts lists for venting instructions, and/or all venting design instructions shall remain with the appliance or equipment at the completion of the installation.

TYPICAL INSTALLATION

GET TO KNOW YOUR WATER HEATER - GAS MODELS

- | | | |
|-------------------------------------|----------------------------------|---|
| A Vent Pipe-Exhaust | N Flue | Z Air Intake Screen - Base Pan |
| B Vent Terminal | O Flue Baffle Assembly** | AA Inner Door |
| C Vent Adapter-Rubber Boot | P Insulation | BB Outer Door |
| D Blower Assembly | Q Control Harness | CC HSI Burner Assembly |
| E Cold Water Inlet | R Rating Plate | DD Air Intake Screen - Blower Assembly |
| F Inlet Water Shut-off Valve | S Gas Supply | EE FV Sensor/Bracket Assembly (40K & 50K Models Only) |
| G Union | T Manual Gas Shut-off Valve | FF FV Sensor/Bracket Assembly (55K & 62.5K Models Only) |
| H Inlet Dip Tube | U Ground Joint Union | |
| J Anode** | V Drip Leg (Sediment Trap) | |
| K Hot Water Outlet | W Drain Valve | |
| L Outlet Receptacle (115 VAC) | X Gas Control Valve / Thermostat | |
| M Temperature-Pressure Relief Valve | Y Metal Drain Pan | |

* ALL PIPING MATERIALS TO BE SUPPLIED BY CUSTOMERS.

** LOCATED UNDER THE BLOWER ASSEMBLY.

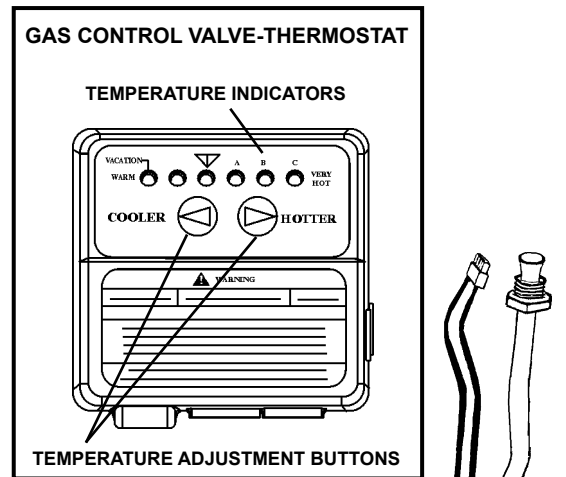
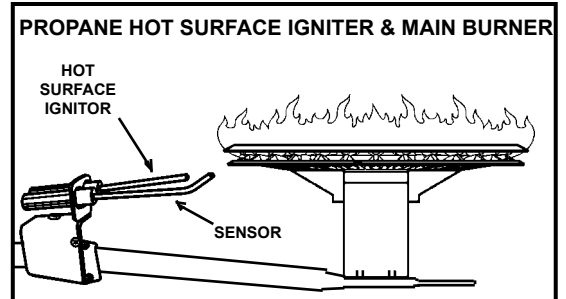
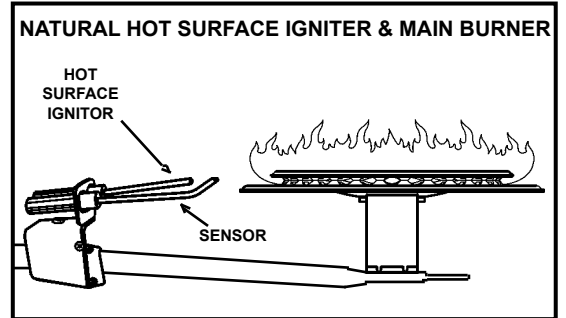
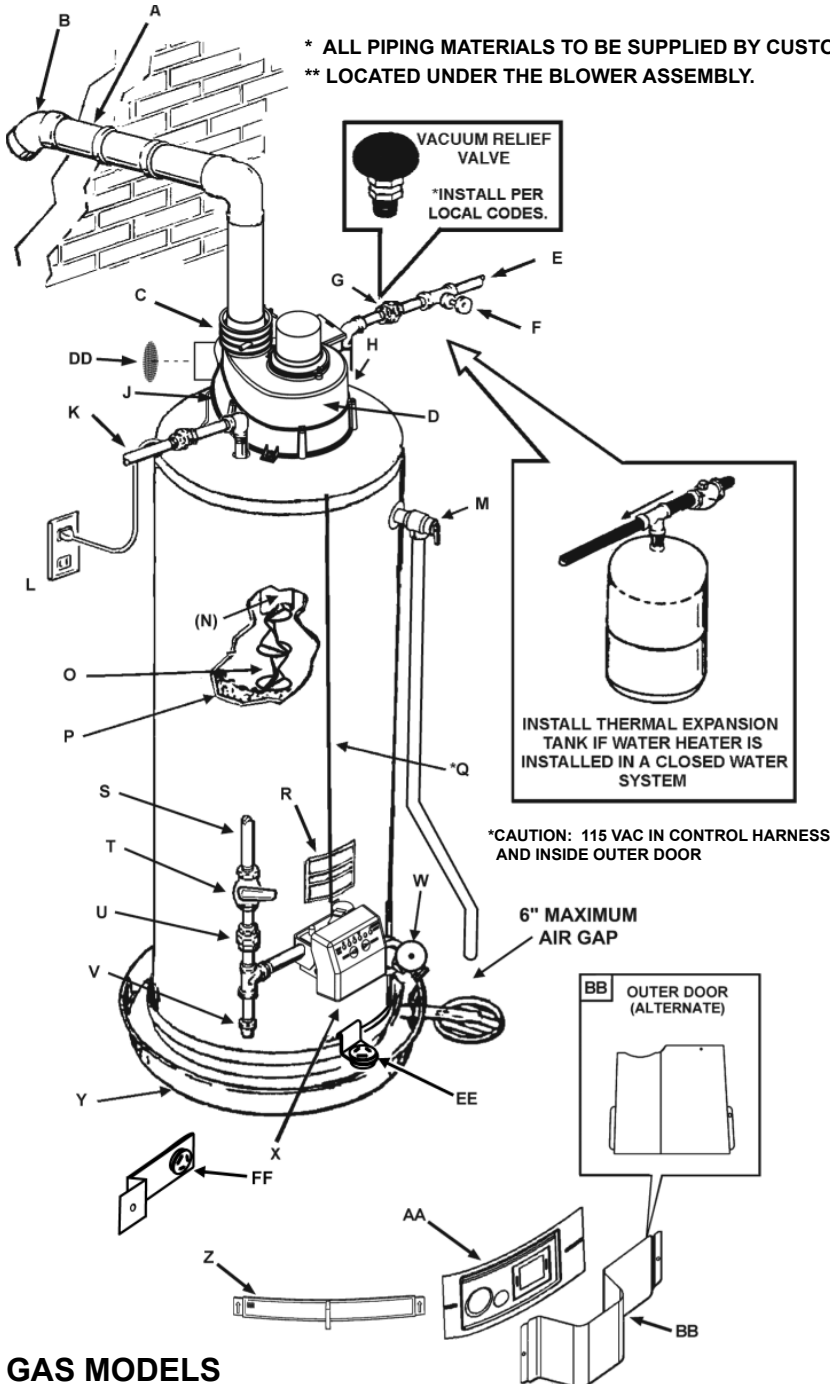

**GAS MODELS
WITH HOT SURFACE IGNITION
& 2", 3" OR 4" PVC VENT CAPABILITY**

FIGURE 1.

TYPICAL INSTALLATION

MIXING VALVE USAGE

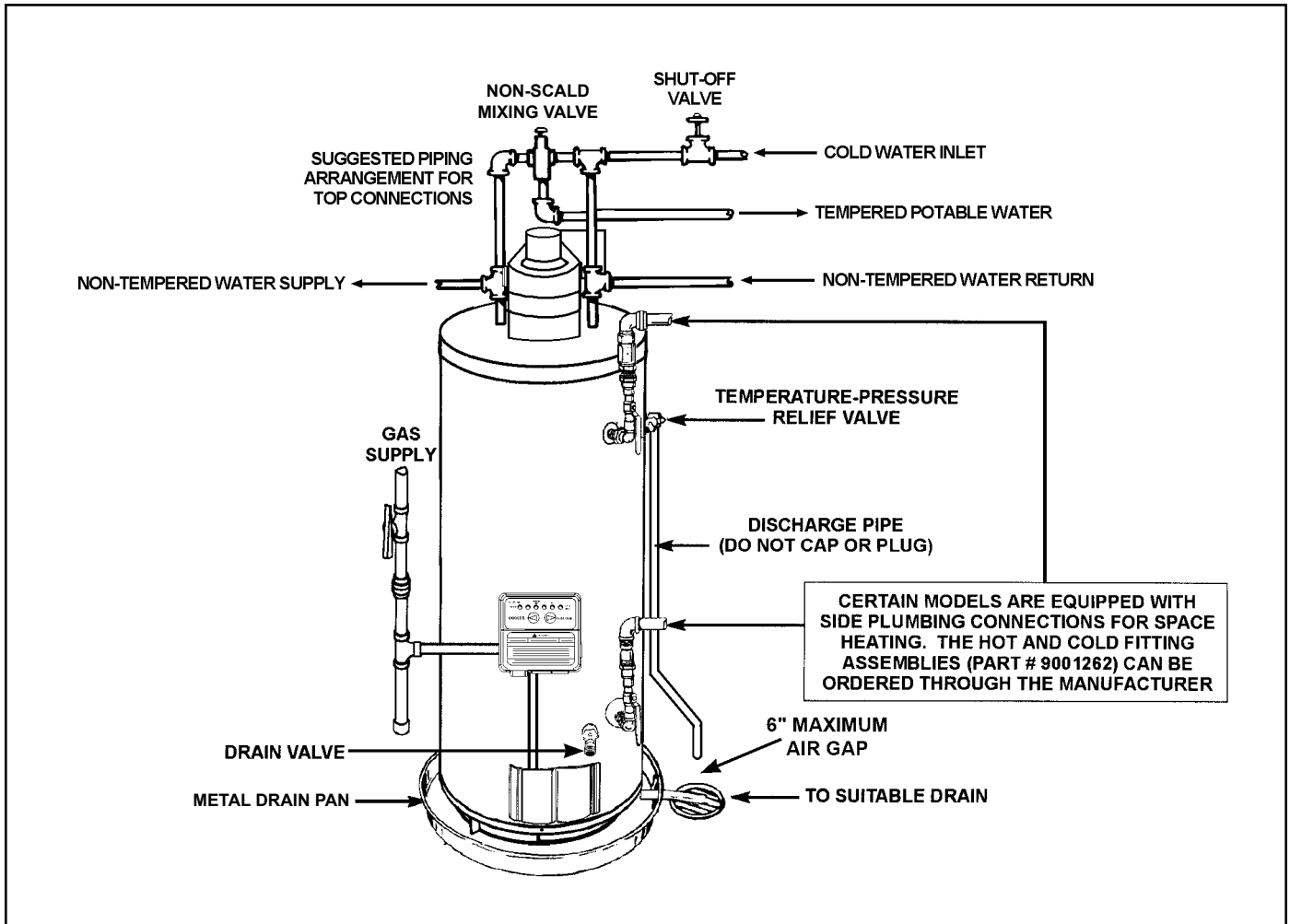

FIGURE 2.

This appliance has been design certified as complying with American National Standard/CSA Standard for water heaters and is considered suitable for:

Water (Potable) Heating and Space Heating: All models are considered suitable for water (potable) heating and space heating.

HOTTER WATER CAN SCALD:

Water heaters are intended to produce hot water. Water heated to a temperature which will satisfy space heating, clothes washing, dish washing, and other sanitizing needs can scald and permanently injure you upon contact. Some people are more likely to be permanently injured by hot water than others. These include the elderly, children, the infirm, or physically/mentally handicapped. If anyone using hot water in your home fits into one of these groups or if there is a local code or state law requiring a certain temperature water at the hot water tap, then you must take special precautions. In addition to using the lowest possible temperature setting that satisfies your hot water needs, a means such as a *Mixing Valve should be used at the hot water taps used by these people or at the water heater. Mixing valves are available at plumbing supply or hardware stores. Consult a Qualified Installer or Service Agency. Follow mixing valve manufacturer's instructions for installation of the valves. Before changing the factory setting on the thermostat, read the "Temperature Regulation" section in this manual, see Figure 19.

	<p>Water temperature over 125°F (52°C) can cause severe burns instantly resulting in severe injury or death.</p> <p>Children, the elderly, and the physically or mentally disabled are at highest risk for scald injury.</p> <p>Feel water before bathing or showering.</p> <p>Temperature limiting valves are available.</p> <p>Read instruction manual for safe temperature setting.</p>
--	--

LOCATING THE NEW WATER HEATER

FACTS TO CONSIDER ABOUT THE LOCATION

Carefully choose an indoor location for the new water heater, because the placement is a very important consideration for the safety of the occupants in the building and for the most economical use of the appliance. **This water heater is not for use in manufactured (mobile) homes or outdoor installation.**

Whether replacing an old water heater or putting the water heater in a new location, the following critical points must be observed:

1. Select a location indoors as close as practical to the vent terminal or location to which the water heater vent piping is going to be connected, and as centralized with the water piping system as possible.
2. Selected location must provide adequate clearances for servicing and proper operation of the water heater.

CAUTION

Property Damage Hazard

- All water heaters eventually leak.
- Do not install without adequate drainage.

Installation of the water heater must be accomplished in such a manner that if the tank or any connections should leak, the flow will not cause damage to the structure. For this reason, it is not advisable to install the water heater in an attic or upper floor. When such locations cannot be avoided, a suitable metal drain pan should be installed under the water heater. Metal drain pans are available at your local hardware store. Such a metal drain pan must have a minimum length and width of at least 2" (5.1 cm) greater than the water heater dimensions and must be piped to an adequate drain. The metal drain pan must not restrict combustion air flow.

Water heater life depends upon water quality, water pressure and the environment in which the water heater is installed. Water heaters are sometimes installed in locations where leakage may result in property damage, even with the use of a metal drain pan piped to a drain. However, unanticipated damage can be reduced or prevented by a leak detector or water shut-off device used in conjunction with a piped metal drain pan. These devices are available from some plumbing supply wholesalers and retailers, and detect and react to leakage in various ways:

- Sensors mounted in the metal drain pan that trigger an alarm or turn off the incoming water to the water heater when leakage is detected.
- Sensors mounted in the metal drain pan that turn off the water supply to the entire home when water is detected in the metal drain pan.
- Water supply shut-off devices that activate based on the water pressure differential between the cold water and hot water pipes connected to the water heater.
- Devices that will turn off the gas supply to a gas water heater while at the same time shutting off its water supply.

INSTALLATIONS IN AREAS WHERE FLAMMABLE LIQUIDS (VAPORS) ARE LIKELY TO BE PRESENT OR STORED (GARAGES, STORAGE AND UTILITY AREAS, ETC.): Flammable liquids (such as gasoline, solvents, propane (LP or butane, etc.) and other substances (such as adhesives, etc.) emit flammable vapors which can be ignited by a gas water heater's hot surface igniter or main burner. The resulting flashback and fire can cause death or serious burns to anyone in the area. This water is equipped with a FV sensor for detecting the presence of flammable vapors, see Figure 3. When the sensor detects those vapors, the unit will shut down and not operate. Should this happen, please refer to the troubleshooting guide on pages 28-30. Even though this water heater is a flammable vapors ignition resistant water heater and is designed to reduce the chances of flammable vapors being ignited, gasoline and other flammable substances should never be stored or used in the same vicinity or area containing a gas water heater or other open flame or spark producing appliance.

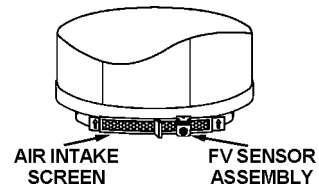

FIGURE 3.

Also, the water heater must be located and/or protected so it is not subject to physical damage by a moving vehicle.

WARNING

Fire or Explosion Hazard

- Do not store or use gasoline or other flammable vapors and liquids in the vicinity of this or any other appliance.
- Avoid all ignition sources if you smell LP gas.
- Do not expose water heater control to excessive gas pressure.
- Use only gas shown on rating plate.
- Maintain required clearances to combustibles.
- Keep ignition sources away from faucets after extended period of non-use.



Read instruction manual before installing, using or servicing water heater.



WARNING

Fire Hazard

For continued protection against risk of fire:

- Do not install water heater on carpeted floor.
- Do not operate water heater if flood damaged.



This water heater must not be installed directly on carpeting. Carpeting must be protected by metal or wood panel beneath the appliance extending beyond the full width and depth of the appliance by at least 3" (7.6 cm) in any direction, or if the appliance is installed in an alcove or closet, the entire floor must be covered by the panel. Failure to heed this warning may result in a fire hazard.

WARNING

Fire or Explosion Hazard

Read instruction manual before installing, using or servicing water heater.

- Improper use may result in fire or explosion.
- Maintain required clearances to combustibles.

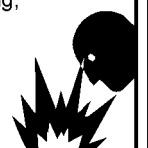

Minimum clearances between the water heater and combustible surfaces are 0 inch at the sides and rear, 5" (12.7 cm) from the front

and 12" (30.5 cm) from the top. (Standard clearance.) If clearances stated on the heater differ from standard clearances, install water heater according to clearances stated on the heater.

Adequate clearance for servicing this appliance should be considered before installation, such as changing the anodes, etc.

A minimum clearance of 5" (12.7 cm) must be allowed for access to replaceable parts such as the thermostats, drain valve and relief valve.

When installing the heater, consideration must be given to proper location. Location selected should be as close to the wall as practicable and as centralized with the water piping system as possible.

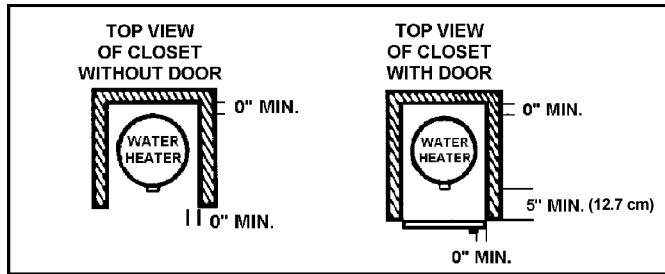

FIGURE 4.

A gas water heater cannot operate properly without the correct amount of air for combustion. Do not install in a confined area such as a closet, unless you provide air as shown in the "Locating The New Water Heater" section. Never obstruct the flow of ventilation air. If you have any doubts or questions at all, call your gas supplier. Failure to provide the proper amount of combustion air can result in a fire or explosion and cause death, serious bodily injury, or property damage.

⚠ WARNING

Breathing Hazard - Carbon Monoxide Gas

- Install water heater in accordance with the instruction manual and NFPA54.
- To avoid injury, combustion and ventilation air must be taken from outdoors.
- Do not place chemical vapor emitting products near water heater.

Breathing carbon monoxide can cause brain damage or death. Always read and understand instruction manual.

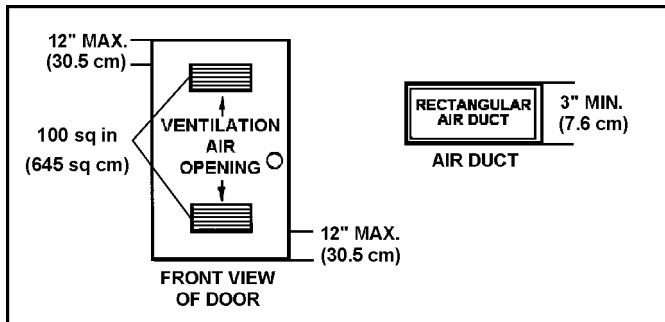

FIGURE 5.

If this water heater will be used in beauty shops, barber shops, cleaning establishments, or self-service laundries with dry cleaning equipment, it is imperative that the water heater or water heaters be installed so that combustion and ventilation air be taken from outside these areas.

Propellants of aerosol sprays and volatile compounds, (cleaners,

chlorine based chemicals, refrigerants, etc.) in addition to being highly flammable in many cases, will also react to form corrosive hydrochloric acid when exposed to the combustion products of the water heater. The results can be hazardous, and also cause product failure.

INSULATION BLANKETS

Insulation blankets are available to the general public for external use on gas water heaters but are not necessary with these products. The purpose of an insulation blanket is to reduce the standby heat loss encountered with storage tank heaters. Your water heater meets or exceeds the National Appliance Energy Conservation Act standards with respect to insulation and standby loss requirements, making an insulation blanket unnecessary.

Should you choose to apply an insulation blanket to this heater, you should follow these instructions (For identification of components mentioned below, see Figure 1). Failure to follow these instructions can restrict the air flow required for proper combustion, potentially resulting in fire, asphyxiation, serious personal injury or death.

⚠ WARNING

Breathing Hazard - Carbon Monoxide Gas

- Do not obstruct water heater air intake with insulating blanket.
- Gas and carbon monoxide detectors are available.
- Install water heater in accordance with the instruction manual.

Breathing carbon monoxide can cause brain damage or death. Always read and understand instruction manual.

- Do not apply insulation to the top of the water heater, as this will interfere with safe operation of the draft hood.
- Do not cover the outer door, thermostat or temperature & pressure relief valve.
- Do not allow insulation to come within 2" (5.1 cm) of the floor to prevent blockage of combustion air flow to the burner.
- Do not cover the instruction manual. Keep it on the side of the water heater or nearby for future reference.
- Do obtain new warning and instruction labels from the manufacturer for placement on the blanket directly over the existing labels.
- Do inspect the insulation blanket frequently to make certain it does not sag, thereby obstructing combustion air flow.

COMBUSTION AIR AND VENTILATION FOR APPLIANCES LOCATED IN UNCONFINED SPACES

UNCONFINED SPACE is space whose volume is not less than 50 cubic feet per 1,000 Btu per hour (4.8 cubic meters per kW) of the aggregate input rating of all appliances installed in that space. Rooms communicating directly with the space in which the appliances are installed, through openings not furnished with doors, are considered a part of the unconfined space.

In unconfined spaces in buildings, infiltration may be adequate to provide air for combustion, ventilation and dilution of flue gases. However, in buildings of tight construction (for example, weather stripping, heavily insulated, caulked, vapor barrier, etc.), additional air may need to be provided using the methods described in "Combustion Air and Ventilation for Appliances Located in Confined Spaces."

COMBUSTION AIR AND VENTILATION FOR APPLIANCES LOCATED IN CONFINED SPACES

CONFINED SPACE is a space whose volume is less than 50 cubic feet per 1,000 Btu per hour (4.8 cm per kW) of the aggregate input rating of all appliances installed in that space.

Chemical vapor corrosion of the flue, blower assembly and vent system may occur if air for combustion contains certain chemical vapors. Spray can propellants, cleaning solvents, refrigerator and air conditioner refrigerants, swimming pool chemicals, calcium and sodium chloride, waxes, bleach and process chemicals are typical compounds which are potentially corrosive.

A. ALL AIR FROM INSIDE BUILDINGS: (See Figure 5 and 6)

The confined space shall be provided with two permanent openings communicating directly with an additional room(s) of sufficient volume so that the combined volume of all spaces meets the criteria for an unconfined space. The total input of all gas utilization equipment installed in the combined space shall be considered in making this determination. Each opening shall have a minimum free area of one square inch per 1,000 Btu per hour (22 cm²/kW) of the total input rating of all gas utilization equipment in the confined space, but not less than 100 square inches (645 cm²). One opening shall commence within 12 inches (31 cm) of the top and one commencing within 12 inches (31 cm) of the bottom of the enclosures.

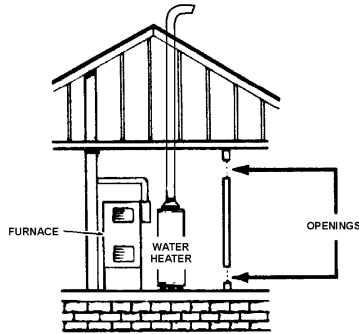

FIGURE 6.

B. ALL AIR FROM OUTDOORS: (See Figures 7, 8 and 9)

The confined space shall be provided with two permanent openings, one commencing within 12 inches (31 cm) of the top and one commencing within 12 inches (31 cm) from the bottom of the enclosure. The openings shall communicate directly, or by ducts, with the outdoors or spaces (crawl or attic) that freely communicate with the outdoors.

1. When directly communicating with the outdoors, each opening shall have a minimum free area of 1 square inch per 4,000 Btu per hour (5.5 cm²/kW) of total input rating of all equipment in the enclosure, see Figure 7.

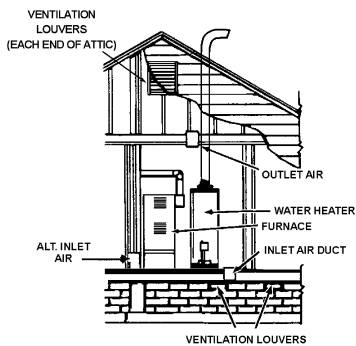

FIGURE 7.

2. When communicating with the outdoors through vertical ducts, each opening shall have a minimum free area of 1 square inch per 4,000 Btu per hour (5.5 cm²/kW) of total input rating of all equipment in the enclosure, see Figure 8.
3. When communicating with the outdoors through horizontal ducts, each opening shall have a minimum free area of 1 square inch per 2,000 Btu per hour (11 cm²/kW) of total input rating of all equipment in the enclosure, see Figure 9.

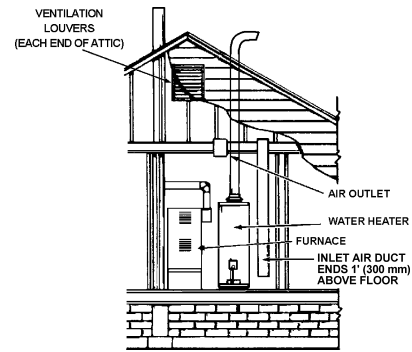

FIGURE 8.

4. When ducts are used, they shall be of the same cross-sectional area as the free area of the openings to which they connect. The minimum short side dimension of rectangular air ducts shall not be less than 3 inches (7.6 cm), see Figure 9.

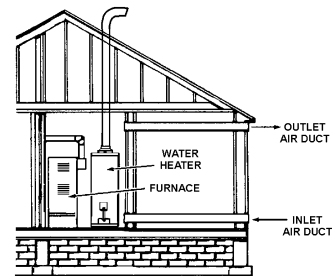

FIGURE 9.

5. Alternatively a single permanent opening may be used when communicating directly with the outdoors, or with spaces that freely communicate with the outdoors. The opening shall have a minimum free area of 1 square inch per 3,000 BTU per hour (8.3 cm²/kW) of total input rating of all equipment in enclosure. See Figure 9A.

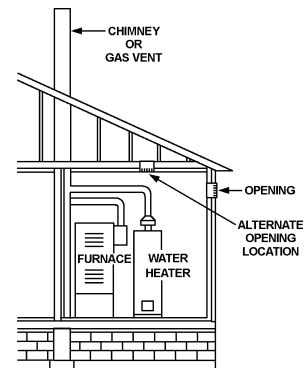

FIGURE 9A.

6. Louvers and Grilles: In calculating free area, consideration shall be given to the blocking effect of louvers, grilles or screens protecting openings. Screens used shall not be smaller than 1/4 inch (6.4 mm) mesh. If the free area through a design of louver or grille is known, it should be used in calculating the size opening required to provide the free area specified. If the design and free area is not known, it may be assumed that wood louvers will be 20-25 percent free area and metal louvers and grilles will have 60-75 percent free area. Louvers and grilles shall be fixed in the open position or interlocked with the equipment so that they are opened automatically during equipment operation.
7. Special Conditions Created by Mechanical Exhausting or Fireplaces: operation of exhaust fans, ventilation systems, clothes dryers or fireplaces may create conditions requiring special attention to avoid unsatisfactory operation of installed gas utilization equipment.

INSTALLING THE NEW WATER HEATER

WATER PIPING

⚠ DANGER

Water temperature over 125°F (52°C) can cause severe burns instantly resulting in severe injury or death.

Children, the elderly, and the physically or mentally disabled are at highest risk for scald injury.

Feel water before bathing or showering.

Temperature limiting valves are available.

Read instruction manual for safe temperature setting.

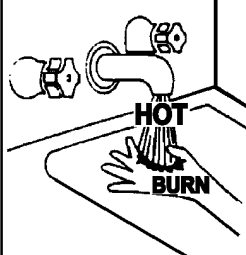

HOTTER WATER CAN SCALD:

Water heaters are intended to produce hot water. Water heated to a temperature which will satisfy space heating, clothes washing, dish washing, cleaning and other sanitizing needs can scald and permanently injure you upon contact. Some people are more likely to be permanently injured by hot water than others. These include the elderly, children, the infirm, or physically/mentally handicapped. If anyone using hot water in your home fits into one of these groups or if there is a local code or state law requiring a certain temperature water at the hot water tap, then you must take special precautions. In addition to using the lowest possible temperature setting that satisfies your hot water needs, a means such as a *mixing valve should be used at the hot water taps used by these people or at the water heater, see Figure 2. Valves for reducing point of use temperature by mixing cold and hot water are also available:

Consult a Qualified Installer or Service Agency. Follow manufacturer's instructions for installation of the valves. Before changing the factory setting on the thermostat, read the "Temperature Regulation" section in this manual.

⚠ WARNING

Toxic Chemical Hazard

- Do not connect to non-potable water system.

This water heater shall not be connected to any heating systems or component(s) used with a non-potable water heating appliance.

All piping components connected to this unit for space heating applications shall be suitable for use with potable water.

Toxic chemicals, such as those used for boiler treatment shall not be introduced into this system.

When the system requires water for space heating at temperatures higher than required for domestic water purposes, a mixing valve must be installed. Please refer to Figure 2 for suggested piping arrangement.

CLOSED WATER SYSTEMS

Water supply systems may, because of code requirements or such conditions as high line pressure, among others, have installed devices such as pressure reducing valves, check valves, and back flow preventers. Devices such as these cause the water system to be a closed system.

THERMAL EXPANSION

As water is heated, it expands (thermal expansion). In a closed system the volume of water will grow. As the volume of water grows there will be a corresponding increase in water pressure due to thermal expansion. Thermal expansion can cause premature tank failure (leakage). This type of failure is not covered under the limited warranty. Thermal expansion can also cause intermittent temperature-pressure relief valve operation: water discharged from the valve due to excessive pressure build up. The temperature-pressure relief valve is not intended for the constant relief of thermal expansion. This condition is not covered under the limited warranty.

A properly sized thermal expansion tank should be installed on all closed systems to control the harmful effects of thermal expansion. Contact a local plumbing service agency to have a thermal expansion tank installed.

NOTE: To protect against untimely corrosion of hot and cold water fittings, it is strongly recommended that di-electric unions or couplings be installed on this water heater when connected to copper pipe.

All gas piping must comply with local codes and ordinances or with the National Fuel Gas Code (ANSI Z223.1/ NFPA-54)(current edition) whichever applies. Copper and brass tubing and fittings (except tin lined copper tubing) shall not be used.

CAUTION

Property Damage Hazard

- Avoid water heater damage.
- Install thermal expansion tank if necessary.
- Do not apply heat to cold water inlet.
- Contact qualified installer or service agency.

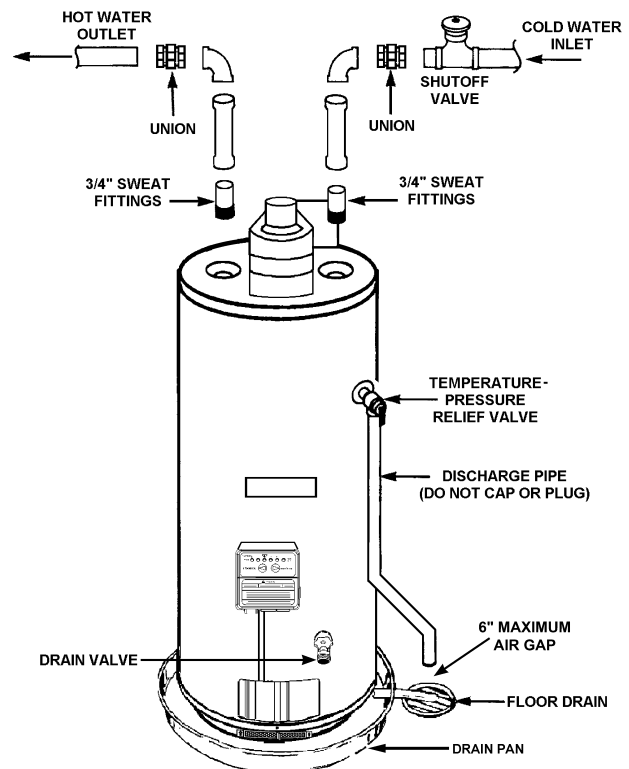

FIGURE 10.

Figure 10 shows the typical attachment of the water piping to the water heater. The water heater is equipped with 3/4 inch NPT water connections.

NOTE: If using copper tubing, solder tubing to an adapter before attaching the adapter to the cold water inlet connection. Do not solder the cold water supply line directly to the cold water inlet. It will harm the dip tube and damage the tank.

T & P Valve and Pipe Insulation (if supplied)

1. Locate the temperature and relief valve on the water heater (also known as a T&P Relief Valve, Figure 11).
2. Locate the slit running the length of the insulation.
3. Spread this slit open and slip it up under the T&P Relief Valve. See Figure 11. Apply gentle pressure to the insulation to ensure it is fully seated on the T&P Relief Valve. Once sealed secure the insulation with a section of duct tape, electrical tape, or equivalent. **IMPORTANT:** The insulation or tape must not block the discharge opening or hinder access to the manual relief lever. Ensure a discharge pipe is installed into the T&P valve discharge opening per the instructions manual.
4. Locate the hot water (outlet) & cold water (inlet) pipes to the water heater.
5. Locate the slit running the length of a section of pipe insulation.
6. Spread the slit open and slip the insulation over the cold water (inlet) pipe. Apply gentle pressure along the length of the insulation to ensure it is fully seated around the pipe. Also ensure that the base of insulation is flush with the water heater. Once seated, secure the insulation with duct tape, electrical tape, or equivalent.
7. Repeat steps 5 through 6 for the hot water (outlet) pipe.
8. Add additional sections of pipe insulation as needed.

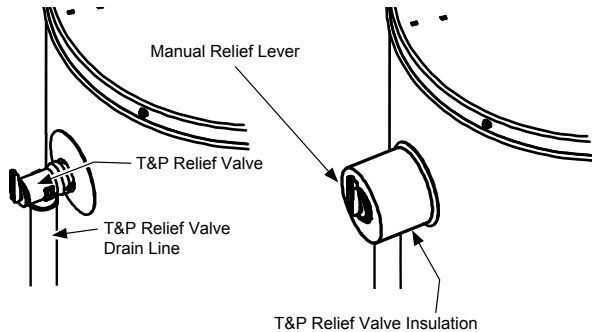

FIGURE 11.

TEMPERATURE-PRESSURE RELIEF VALVE

	<h2>⚠ WARNING</h2> <h3>Explosion Hazard</h3>
	<ul style="list-style-type: none"> • Temperature-pressure relief valve must comply with ANSI Z21.22- CSA 4.4 and ASME code. • Properly sized temperature-relief valve must be installed in opening provided. • Can result in overheating and excessive tank pressure. • Can cause serious injury or death.

This heater is provided with a properly certified combination temperature - pressure relief valve by the manufacturer.

The valve is certified by a nationally recognized testing laboratory that maintains periodic inspection of production of listed equipment of materials as meeting the requirements for Relief Valves for Hot Water Supply Systems, ANSI Z21.22 • CSA 4.4, and the code requirements of ASME.

If replaced, the valve must meet the requirements of local codes, but not less than a combination temperature and pressure relief valve certified as indicated in the above paragraph.

The valve must be marked with a maximum set pressure not to exceed the marked hydrostatic working pressure of the water heater (150 psi = 1,035 kPa) and a discharge capacity not less than the water heater input rate as shown on the model rating plate.

For safe operation of the water heater, the relief valve must not be removed from its designated opening nor plugged.

The temperature-pressure relief valve must be installed directly into the fitting of the water heater designed for the relief valve. Position the valve downward and provide tubing so that any discharge will exit only within 6 inches (15.2 cm) above, or at any distance below the structural floor. Be certain that no contact is made with any live electrical part. The discharge opening must not be blocked or reduced in size under any circumstances. Excessive length, over 30 feet (9.14 m), or use of more than four elbows can cause restriction and reduce the discharge capacity of the valve, see Figures 10 or 14.

No valve or other obstruction is to be placed between the relief valve and the tank. Do not connect tubing directly to discharge drain unless a 6" (15.2 cm) air gap is provided. To prevent bodily injury, hazard to life, or property damage, the relief valve must be allowed to discharge water in quantities should circumstances demand. If the discharge pipe is not connected to a drain or other suitable means, the water flow may cause property damage.

<h1>CAUTION</h1> <h2>Water Damage Hazard</h2>
<ul style="list-style-type: none"> • Temperature-pressure relief valve discharge pipe must terminate at adequate drain.

The Discharge Pipe:

- Shall not be smaller in size than the outlet pipe size of the valve, or have any reducing couplings or other restrictions.
- Shall not be plugged or blocked.
- Shall be of material listed for hot water distribution.
- Shall be installed so as to allow complete drainage of both the temperature-pressure relief valve, and the discharge pipe.
- Must terminate a maximum of six inches above a floor drain or external to the building. In cold climates, it is recommended that the discharge pipe be terminated at an adequate drain inside the building.
- Shall not have any valve between the relief valve and tank.

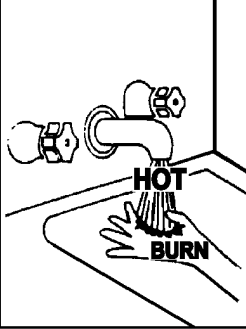
	<p>⚠ DANGER Water temperature over 125°F (52°C) can cause severe burns instantly resulting in severe injury or death.</p> <p>Children, the elderly, and the physically or mentally disabled are at highest risk for scald injury.</p> <p>Feel water before bathing or showering.</p> <p>Temperature limiting valves are available.</p> <p>Read instruction manual for safe temperature setting.</p>
---	--

The temperature-pressure relief valve must be manually operated at least once a year. Caution should be taken to ensure that (1) no one is in front of or around the outlet of the temperature-pressure relief valve discharge line, and (2) the water manually discharged will not cause any bodily injury or property damage because the water may be extremely hot.

If after manually operating the valve, it fails to completely reset and continues to release water, immediately close the cold water inlet to the water heater, follow the draining instructions, and replace the temperature-pressure relief valve with a new one.

GAS PIPING

	<p>⚠ WARNING</p> <p>Fire and Explosion Hazard</p> <ul style="list-style-type: none"> • Do not use water heater with any gas other than the gas shown on the rating plate. • Excessive pressure to gas control valve can cause serious injury or death. • Turn off gas lines during installation. • Contact qualified installer or service agency.
--	---

Make sure the gas supplied is the same type listed on the model rating plate. The inlet gas pressure must not exceed 14 inch water column (3.5 kPa) for natural and propane gas (L.P.). The minimum inlet gas pressure shown on the rating plate is that which will permit firing at rated input.

All gas piping must comply with local codes and ordinances or with the National Fuel Gas Code (ANSI Z223.1/NFPA-54)(current edition) whichever applies. Copper and brass tubing and fittings (except tin lined copper tubing) shall not be used.

If the gas control valve is subjected to pressures exceeding 1/2 psi (14 inches water column) (3.5 kPa), the damage to the gas control valve could result in a fire or explosion from leaking gas.

If the main gas line Shut-off serving all gas appliances is used, also turn "off" the gas at each appliance. Leave all gas appliances shut "off" until the water heater installation is complete.

A gas line of sufficient size must be run to the water heater. Consult the current edition of National Fuel Gas Code ANSI Z223.1/NFPA 54 and your gas supplier concerning pipe size.

There must be:

- A readily accessible manual shut off valve in the gas supply line

serving the water heater, and

- A drip leg (sediment trap) ahead of the gas control valve to help prevent dirt and foreign materials from entering the gas control valve.
- A flexible gas connector or a ground joint union between the shut off valve and control valve to permit servicing of the unit.

Be sure to check all the gas piping for leaks before lighting the water heater. Use a soapy water solution, not a match or open flame. Rinse off soapy solution and wipe dry.

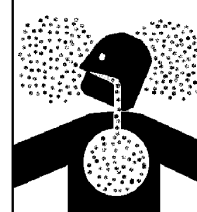
<p>⚠ WARNING</p> <p>Breathing Hazard - Carbon Monoxide Gas</p>	
	<ul style="list-style-type: none"> • High altitude orifice must be installed for operation above 7,700 ft (2,347 m). • Contact a qualified installer or service agency.
<p>Breathing carbon monoxide can cause brain damage or death. Always read and understand instruction manual.</p>	

When installed at elevations above 7,700 feet (2,347 meters), input rating should be reduced at the rate of 4 percent for each 1,000 feet (305 meters) above sea level which requires replacement of the burner orifice in accordance with National Fuel Gas Code ANSI Z223.1/NFPA 54. Contact your local gas supplier for further information.

Failure to replace the standard orifice with a high altitude orifice when installed could result in improper and inefficient operation of the appliance, producing carbon monoxide gas in excess of safe limits, which could result in serious injury or death. Contact your gas supplier for any specific changes which may be required in your area.

	<p>⚠ WARNING</p> <p>Fire and Explosion Hazard</p> <ul style="list-style-type: none"> • Use joint compound or tape compatible with propane. • Leak test before operating heater. • Disconnect gas piping and shut-off valve before pressure testing system.
--	---

Use pipe joint compound or teflon tape marked as being resistant to the action of petroleum [Propane (L.P.)] gases.

The appliance and its gas connection must be leak tested before placing the appliance in operation.

The appliance and its individual Shut-off valve shall be disconnected from the gas supply piping system during any pressure testing of that system at test pressures in excess of 1/2 pound per square inch (14 inches water column) (3.5 kPa). It shall be isolated from the gas supply piping system by closing its individual manual Shut-off valve during any pressure testing of the gas supply piping system at test pressures equal to or less than 1/2 pound per square inch (3.5 kPa).

Connecting the gas piping to the gas control valve of the water heater can be accomplished by either of the two methods shown in Figures 12 and 13.

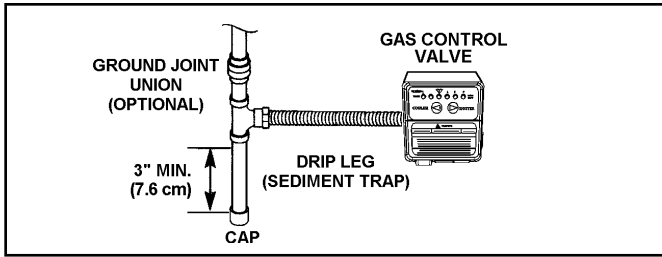

FIGURE 12. GAS PIPING WITH FLEXIBLE CONNECTOR.

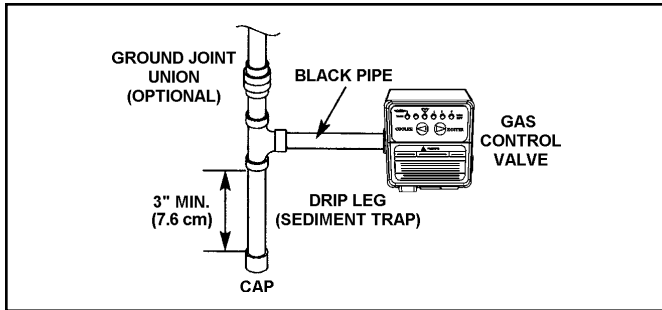

FIGURE 13. GAS PIPING WITH ALL BLACK IRON PIPE TO GAS CONTROL VALVE.

SEDIMENT TRAPS

	<h3>⚠ WARNING</h3>
	<p>Fire and Explosion Hazard</p> <ul style="list-style-type: none"> • Contaminants in gas lines can cause fire or explosion. • Clean all gas piping before installation. • Install drip leg in accordance with NFPA54.

A sediment trap (drip leg) shall be installed as close to the inlet of the water heater as practical at the time of water heater installation. The sediment trap shall be either a tee fitting with a capped nipple in the bottom outlet or other device recognized as an effective sediment trap (drip leg). If a tee fitting is used, it shall be installed in conformance with one of the methods of installation shown in Figures 12 and 13.

Contaminants in the gas lines may cause improper operation of the gas control valve that may result in fire or explosion. Before attaching the gas line be sure that all gas pipe is clean on the inside. To trap any dirt or foreign material in the gas supply line, a drip leg (sometimes called a sediment trap) must be incorporated in the piping. The drip leg must be readily accessible. Install in accordance with the "Gas Piping" section. Refer to the current edition of the National Fuel Gas Code, ANSI Z223.1/NFPA 54.

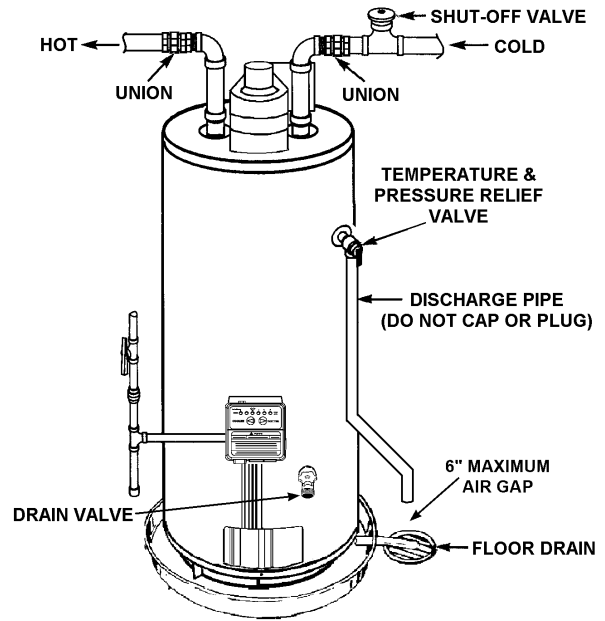

FIGURE 14.

FILLING THE WATER HEATER

<h1>CAUTION</h1>
<p>Property Damage Hazard</p>
<ul style="list-style-type: none"> • Avoid water heater damage. • Fill tank with water before operating.

Never use this water heater unless it is completely full of water. To prevent damage to the tank, the tank must be filled with water. Water must flow from the hot water faucet before turning "ON" gas to the water heater.

To fill the water heater with water:

1. Close the water heater drain valve by turning the handle to the right (clockwise). The drain valve is on the lower front of the water heater.
2. Open the cold water supply valve to the water heater. **NOTE: The cold water supply valve must be left open when the water heater is in use.**
3. To insure complete filling of the tank, allow air to exit by opening the nearest hot water faucet. Allow water to run until a constant flow is obtained. This will let air out of the water heater and the piping.
4. Check all water piping and connections for leaks. Repair as needed.

BLOWER ASSEMBLY INSTALLATION

SEQUENCE OF INSTALLATION

1. This power vented water heater comes with the blower assembly installed.
2. After the unit is set in place, make sure the blower assembly is still mounted securely and the air intake screen of the blower assembly is installed in the dilution air opening. Also make sure the drain port of the rubber boot vent adapter is capped off. Lastly, make sure there is no damage to the blower.
3. Make sure there is no packing material in the discharge of the blower or the intake of the dilution air restrictor, see Figure 15.
4. Make sure that the plastic tubing is still attached from the air pressure switch to the port on the blower housing. Make sure the plastic tubing is not folded anywhere between the pressure switch and the blower housing.

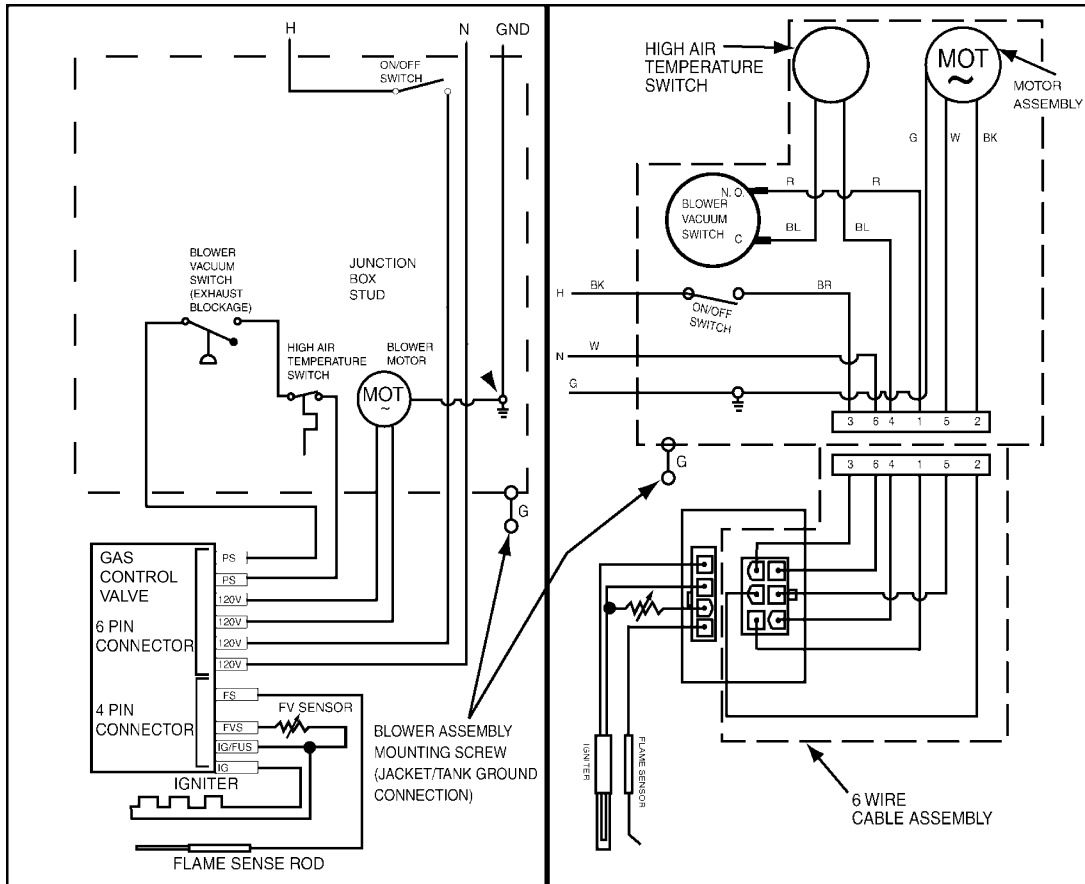

You must provide all wiring of the proper size outside of the water heater. You must obey local codes and electric utility requirements when you install this wiring.

This appliance must be electrically grounded in accordance with local codes, or in the absence of local codes, with the National Electrical Code ANSI/NFPA No 70(current edition) AND OR THE CSA C22.1 ELECTRICAL CODE.(current edition) Outlets and field installed power supplies must have correct polarity or the water heater will not operate.

Note: If any of the original wire as supplied with the appliance must be replaced, it must be replaced with 105°C wire or its equivalent.

DIAGRAM 1

5. Make sure the ON/OFF switch is in the OFF position and that the outer harness is connected from the blower control box to the connector on the bottom side of the gas control valve.
6. If the outer harness is not factory installed, make sure the ON/OFF switch is in the OFF position and then connect the outer harness from the blower control box to the connector on the bottom side of the gas control valve.
8. Do not plug in power cord until vent system is completely installed. This powered vent heater operates on 110-120 Vac, therefore a grounded outlet must be within reach of the six (6) foot (1.8 m) flexible power cord supplied with the unit (see Figure 1). The power cord supplied may be used only where local codes permit. If local codes do not permit the use of a flexible power supply cord:

⚠ WARNING

- Before servicing the water heater, make sure the blower assembly is unplugged or the electrical supply to the water heater is turned "OFF".
- Label all wires prior to disconnection when servicing controls. Wiring error can cause improper and dangerous operation. Verify proper operation after servicing.
- Failure to do this could result in death, serious bodily injury, or property damage.

7. This water heater is a polarity sensitive appliance and will not operate if the power supply polarity is reversed. The power supply or outlet providing power to this water heater must be wired properly (correct polarity).

- a.) Make sure the unit is unplugged from wall outlet. Remove screws and open panel on front of control box.
- b.) Cut the flexible power cord, leaving enough to be able to make connections, then remove the strain relief fitting from box.
- c.) Install suitable conduit fitting in side of enclosure and then follow (d.) and (e.) below.
- d.) Splice field wiring into existing wiring using code authorized method (wire nuts, etc.).
- e.) Be certain that neutral and live connections are not reversed when making these connections.
- f.) Close panel on the side of control box, make sure that access panel is secured shut.

VENT CONNECTIONS TO BLOWER ASSEMBLY

Figure 15 shows the optimal placement of the 2" to 3" or 3" to 4" reducer; however, the vent can be reduced at any point in the vent system as long as the maximum and minimum vent length requirements are met.

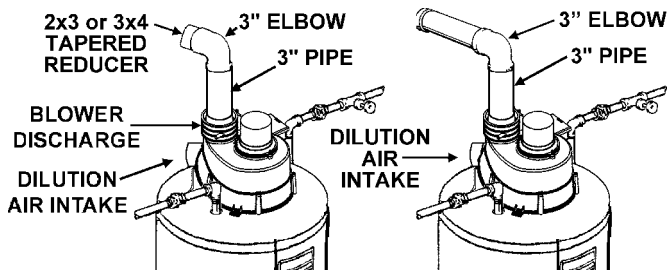

FIGURE 15.

VENTING AND INSTALLATION

Plan the layout of the vent system from the vent termination to the water heater considering all of the 90° and 45° elbows plus the number of feet of pipe that would be needed to install the total vent system. The water heater must be vented to the outdoors as described in these instructions. DO NOT connect this water heater to an existing vent or chimney. It must be vented separately from all other appliances. The fittings, other than the supplied Vent Termination should be equivalent to the following: PVC (Schedule 40, DWV, ASTM D-2665), CPVC (Schedule 40, DWV, ASTM F-438), ABS (Schedule 40 DWV, ASTM D-2661).

The cement used should be as recommended by the vent pipe manufacturer. See the instructions on pages 18 and 19 for the proper method of cutting and cementing the PVC pipe and fittings.

The unit may be vented horizontally through a wall or vertically through the roof. Pipe runs must be adequately supported along both vertical and horizontal runs as follows:

- For Schedule 40, 2" PVC, ABS vent pipe: Every 3 feet (0.9 m).
- For Schedule 40, 3" PVC, ABS vent pipe: Every 3.5 feet (1.1 m).
- For Schedule 40, 4" PVC, ABS vent pipe: Every 4 feet (1.2 m).
- For Schedule 40, 2" CPVC vent pipe: Every 5 feet (1.5 m).
- For Schedule 40, 3" CPVC vent pipe: Every 6 feet (1.8 m).
- For Schedule 40, 4" CPVC vent pipe: Every 6.5 feet (2.0 m).

It is imperative that the first hanger (or support) be located on the horizontal run immediately adjacent to the first 90-degree elbow from the vertical rise. Support method used should isolate the vent pipe from the floor joists or other structural members to prevent the transmission of noise and vibration. Do not support, pin, or otherwise secure the venting system in a way that restricts the normal thermal expansion and contraction of the chosen venting material.

If the water heater is being installed as a replacement for an existing power vented heater in pre-existing venting, a thorough inspection of the existing venting system must be performed prior to any installation work. Verify that the correct material as detailed above has been used, and that the minimum or maximum vent lengths and terminal location as detailed in this manual have been met. Carefully inspect the entire venting system for any signs of cracks or fractures, particularly at

the joints between elbows and other fittings and the straight runs of vent pipe. Check the system for signs of sagging or other stresses in the joints as a result of misalignment of any components in the system. If any of these conditions are found, they must be corrected in accordance with the venting instructions in this manual before completing the installation and putting the water heater into service.

Except where instructed in this manual, the mixing of 2", 3" and 4" vent pipe is NOT ALLOWED. If 2" pipe is to be used, then a 2" to 3" bell reducer is recommended. Figure 15 shows the recommended location for the bell reducer. If the bell reducer is located at the rubber boot on the blower assembly, then a short section of 3" vent pipe needs to be installed in the rubber boot for proper connection of the 2" to 3" bell reducer. That length can be of the minimum length required for the connection.

If 4" pipe is to be used, then a 3" to 4" bell reducer is recommended. Figure 15 shows the recommended location for the bell reducer. If the bell reducer is located at the rubber boot on the blower assembly, then a short section of 3" vent pipe needs to be installed in the rubber boot for proper connection of the 3" to 4" bell reducer. That length can be of the minimum length required for the connection.

The 40,000, 50,000, 55,000 and 62,500 BTU units are supplied with a 2" Schedule 40 PVC 22.5° Vent Terminal. If you decide to vent with 3" or 4" pipe, a Schedule 40 DWV 45° Vent Terminal must be used. For your convenience, we have included a screen for both 3" and 4" Vent Terminals.

The vent piping should be connected to the blower with a rubber adapter and secured with hose clamps. The adapter and clamps are provided with the heater.

Even the flue gas temperature leaving the blower is between 140°F (69°C) and 175°F (79°C), some installations will have water condensate in the vent piping. If this occurs, then adequate means of draining and disposing of the condensate needs to be made by the installer.

CONDENSATE

Condensate formation does not occur in all installations of power vented water heaters, but should be protected against on installations where it can form in the venting system. Condensation in the venting system of power vented water heaters is dependent upon installation conditions including, but not limited to ambient temperature and humidity of installation location, ambient temperature and humidity of venting space, vent discharge and slope, and product usage. In certain conditions, installations in unconditioned space or having long horizontal or vertical vent runs may accumulate condensate. In these conditions, the vent pipe should be sloped downward away from the blower assembly 1/4" (6.4 mm) per five feet (1.5 m) of pipe but not more than 1 1/2" (3.8 cm) in the total vent length. If the vent piping is vented level or sloped upwards away from the blower assembly, then adequate means for draining and disposing of the condensate needs to be made by the installer (if condensate is detected). If you have condensate, then a 3/8" drain hose can be connected to the built-in drain port of the rubber boot on the blower assembly. For your convenience, the rubber boot is supplied with a removable cap on the built-in drain port. Prior to operating the water heater, make sure the removable cap is installed on the drain port (if a drain hose is not needed).

MAXIMUM AND MINIMUM VENT LENGTHS

40,000 BTU Units:

For 2" Venting, the maximum equivalent feet of pipe allowed is 40 feet (12.2 m). This does not include the supplied vent termination for the water heater. For the 2" venting, one 90° elbow is approximately equal to 5 feet (1.5 m). One 45° elbow is approximately equal to 2.5 feet (0.8 m). It is recommended that at least 2 feet (0.6 m) of spacing be used in between all 45° elbows and all 90° elbows.

For 3" Venting, the maximum equivalent feet of pipe allowed is 120 feet (36.6 m). This does not include the Vent Termination (supplied locally) for the water heater. For the 3" venting, one 90° elbow is approximately equal to 5 feet (1.5 m). One 45° elbow is approximately equal to 2.5 feet (0.8 m). It is recommended that at least 2 feet (0.6 m) of spacing be used in between all 45° elbows and all 90° elbows.

For 4" Venting, the maximum equivalent feet of pipe allowed is 160 feet (48.8 m). This does not include the Vent Termination (supplied locally) for the water heater. For the 4" venting, one 90° elbow is approximately equal to 8 feet (2.4 m). One 45° elbow is approximately equal to 4 feet (1.2 m). It is recommended that at least 2 feet (0.6 m) of spacing be used in between all 45° elbows and all 90° elbows.

50,000 BTU Units:

For 2" Venting, the maximum equivalent feet of pipe allowed is 40 feet (12.2 m). This does not include the supplied Vent Termination for the water heater. For the 2" venting, one 90° elbow is approximately equal to 5 feet (1.5 m). One 45° elbow is approximately equal to 2.5 feet (0.8 m). It is recommended that at least 2 feet (0.6 m) of spacing be used in between all 45° elbows and all 90° elbows.

For 3" Venting, the maximum equivalent feet of pipe allowed is 120 feet (36.6 m). This does not include the Vent Termination (supplied locally) for the water heater. For the 3" venting, one 90° elbow is approximately equal to 5 feet (1.5 m). One 45° elbow is approximately equal to 2.5 feet (0.8 m). It is recommended that at least 2 feet (0.6 m) of spacing be used in between all 45° elbows and all 90° elbows.

For 4" Venting, the maximum equivalent feet of pipe allowed is 160 feet (48.8 m). This does not include the Vent Termination (supplied locally) for the water heater. For the 4" venting, one 90° elbow is approximately equal to 8 feet (2.4 m). One 45° elbow is approximately equal to 4 feet (1.2 m). It is recommended that at least 2 feet (0.6 m) of spacing be used in between all 45° elbows and all 90° elbows.

55,000 and 62,500 BTU Units:

NOTE: The 55,000 and 62,500 BTU Units are not approved for 2" venting.

For 3" Venting, the maximum equivalent feet of pipe allowed is 80 feet (24.4 m). This does not include the supplied Vent Termination for the water heater. For the 3" venting, one 90° elbow is approximately equal to 5 feet (1.5 m). One 45° elbow is approximately equal to 2.5 feet (0.8 m). It is recommended that at least 2 feet (0.6 m) of spacing be used in between all 45° elbows and all 90° elbows.

For 4" Venting, the maximum equivalent feet of pipe allowed is 120 feet (36.6 m). This does not include the Vent Termination (supplied locally) for the water heater. For the 4" venting, one 90° elbow is approximately equal to 8 feet (2.4 m). One 45° elbow is approximately equal to 4 feet (1.2 m). It is recommended that at least 2 feet (0.6 m) of spacing be used in between all 45° elbows and all 90° elbows.

⚠ WARNING

Breathing Hazard - Carbon Monoxide Gas

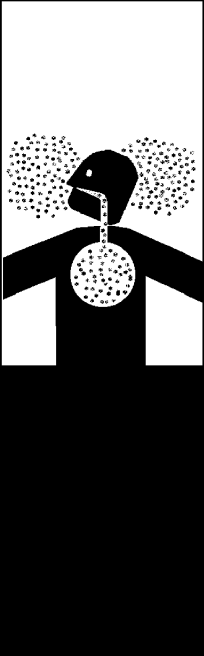

- Install vent system in accordance with codes.
- Do not operate water heater if flood damaged.
- High altitude orifice must be installed for operation above 7,700 feet.
- Do not operate if soot buildup.
- Do not obstruct water heater air intake with insulating jacket.
- Do not place chemical vapor emitting products near water heater.
- Gas and carbon monoxide detectors are available.
- Never operate the heater unless it is vented to the outdoors and has adequate air supply to avoid risks of improper operation, fire, explosion, or asphyxiation.
- Make sure the flue baffle and flue restrictor ring are properly aligned and inserted on top of the flue. This can be checked through the dilution air inlet of the blower assembly. For viewing, the Air Intake screen of the blower assembly will have to be removed. Replace after the check is made.

Breathing carbon monoxide can cause brain damage or death.
Always read and understand instruction manual.

VENTING

The vent system must terminate so that proper clearances are maintained as cited in local codes or the current edition of the [National Fuel Gas Code](#), ANSI Z223.1/NFPA 54, 7.3.4e and 7.8a,b, as follows:

1. The exit terminals of a mechanical vent system shall be not less than 7 feet (2.13 m) above grade when located adjacent to public walkways, see Figure 16.
2. A venting system shall terminate at least 3 feet (0.91 m) above any forced air inlet located within 10 feet (3.1 m), see Figure 16.
3. The venting system shall terminate at least 4 feet (1.2 m) below, 4 feet (1.2 m) horizontally from or, 1 foot (0.31 m) above any door, window or gravity air inlet into any building.

The manufacturer also recommends that the vent termination should not be installed closer than 18" (45.7 cm) from an inside corner of an L shaped structure and not be less than 1 foot (0.31 m) above grade.

The vent shall terminate a minimum of 12" (30.5 cm) above expected snowfall level to prevent blockage of vent termination, see Figure 16.

4. In cold climates, it is recommended that vent termination not be mounted directly above or within 3 feet (0.91 m) horizontally from an oil tank vent or gas meter to avoid potential freeze-up from condensation, see Figure 16..

Plan the vent system layout so that proper clearances are maintained from plumbing and wiring.

Vent pipes serving power vented appliances are classified by building codes as "vent connectors". Required clearances from combustible materials must be provided in accordance with information in this manual under LOCATION OF HEATER and VENT TERMINAL INSTALLATIONS, and with the National Fuel Gas Code and local codes.

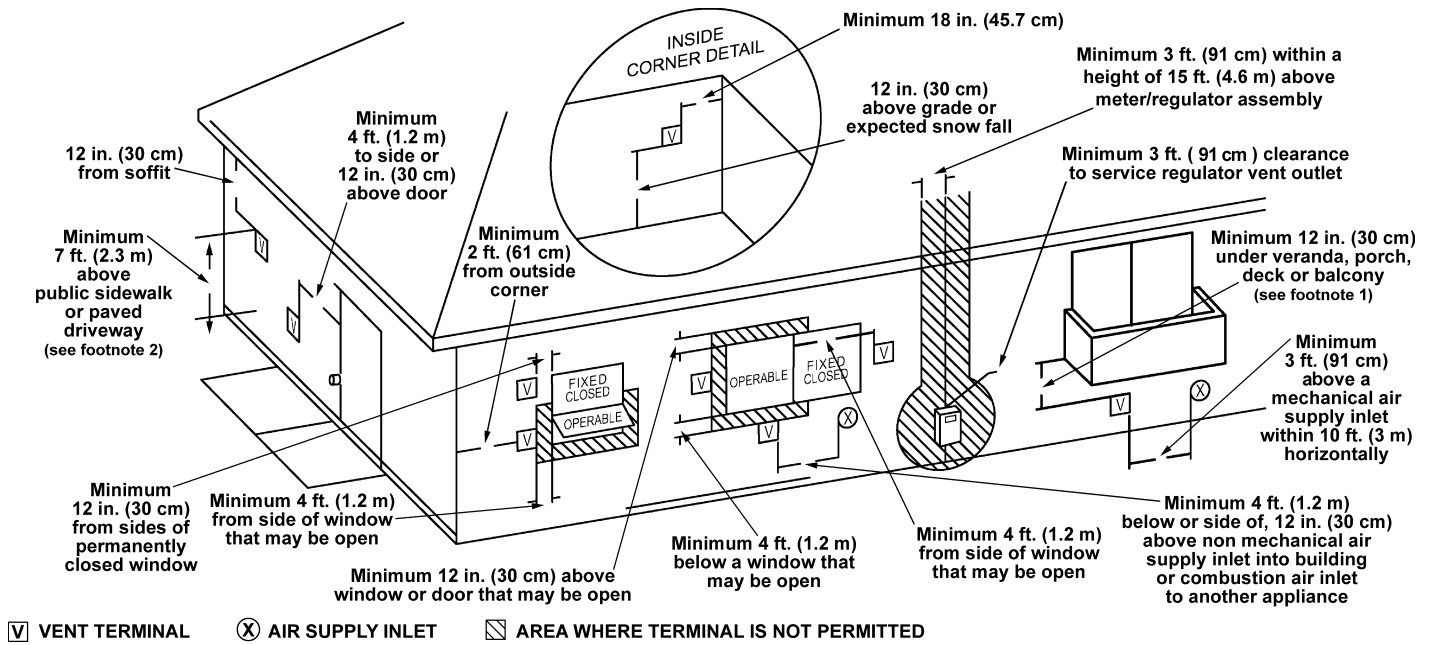

1. Permitted only if veranda, porch, deck or balcony is fully opened on a minimum of two sides beneath the floor.
2. A vent shall not terminate above a sidewalk or paved driveway that is located between two single family dwellings and serves both dwellings.

FIGURE 16.

This unit can vent through 2", 3" or 4" nonmetallic pipe and fittings.

The vent pipe installation can be started from either the blower discharge or the termination wall. Keep in mind the total vent system (pipe and elbows) when installing the vent system, see VENTING AND INSTALLATION, pages 15 - 17.

VERTICAL VENT TERMINATION RESTRICTIONS

1. Minimum of twelve 12" (30.5 cm) above the roof or twelve 12" (30.5 cm) above the anticipated snow level. Provide proper support for all pipe protruding through the roof.

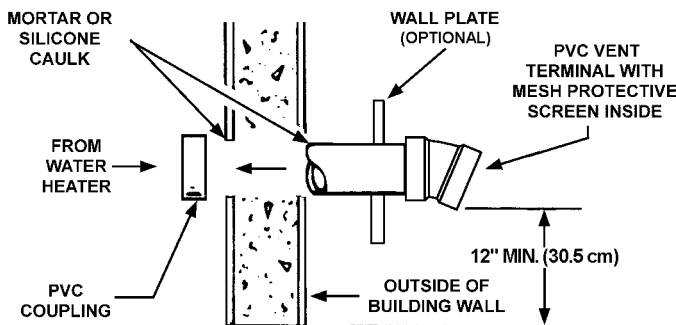

FIGURE 17.

The vent terminal should be kept as close as possible to the outside wall, but you need to allow at least 1.5" (3.8 cm) of pipe past the wall, for the wall flange and vent terminal to mount on the pipe.

Before the vent terminal is installed, caulk (not supplied) around the pipe on the exterior wall and install the optional wall flange. The flange can be held to the outside wall by placing some of the caulking on the back of the flange. The wall flange is supplied for decorative purposes only and is not a requirement for the vent termination (if not needed by the installer).

VERTICAL VENT THROUGH ROOF

This unit is approved for venting through the roof with the type vent terminal that is included with the unit. A proper flashing or "BOOT" should be used to seal the pipe where it exits the roof.

The total vent system should not exceed that which is specified, see VENTING AND INSTALLATION, pages 15 - 17.

All of the pipe should be secured as per the instructions in the instructions in the VENTING AND INSTALLATION, pages 15 - 17.

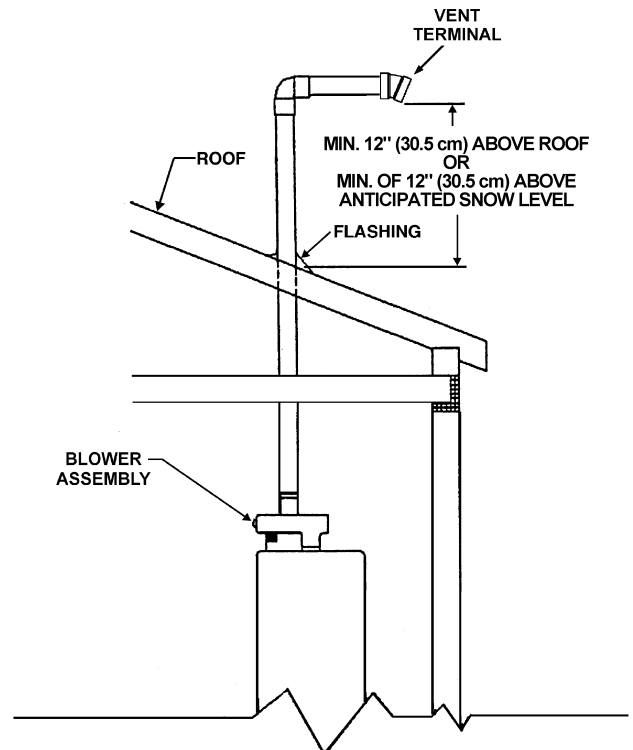

FIGURE 18.

2. 4' (1.2 m) from or 1' (0.3 m) above any gable, dormer, or other roof structure with access to interior of building (i.e.-vent, window etc.).
3. 3' (0.9 m) above any forced air inlet located within 10' (3.0 m).

VENT PIPE PREPARATION

1. INITIAL PREPARATION

- A. Make sure the solvent cement you are planning to use is designed for the specific application you are attempting.
- B. Know the physical and chemical characteristics and limitations of the PVC and CPVC piping materials that you are about to use.
- C. Know the reputation of your manufacturer and their products.
- D. Know your own qualifications or those of your contractor. The solvent welding technique of joining PVC and CPVC pipe is a specialized skill just as any other pipe fitting technique.
- E. Closely supervise the installation and inspect the finished job before start-up.
- F. Contact the manufacturer, supplier, or competent consulting agency if you have any questions about the application or installation of PVC and CPVC pipe.
- G. Take the time and effort to do a professional job. Shortcuts will only cause you problems and delays in start-up. By far, the majority of failures in PVC and CPVC systems are the result of shortcuts and/or improper joining techniques.

2. SELECTION OF MATERIALS

- Cutting Device - Saw or Pipe Cutter
- Deburring Tool, Knife, File, or Beveling Machine (2" and above)
- Brush - Pure Bristle
- Rag - Cotton (Not Synthetic)
- Primer and Cleaner
- Solvent Cement - PVC for PVC Components and CPVC for CPVC Components
- Containers - Metal or Glass to hold Primer and Cement. Select the type of PVC or CPVC materials to be used on the basis of their application with respect to chemical resistance, pressure rating, temperature characteristics, etc.
- Insertion Tool - Helpful for larger diameter pipe and fittings 6 inches (15.2 cm) and above.

⚠ WARNING

Fire or Explosion Hazard

- Do not store or use gasoline or other flammable vapors and liquids in the vicinity of this or any other appliance.
- Avoid all ignition sources if you smell LP gas.
- Do not expose water heater control to excessive gas pressure.
- Use only gas shown on rating plate.
- Maintain required clearances to combustibles.
- Keep ignition sources away from faucets after extended period of non-use.



Read instruction manual before installing, using or servicing water heater.



PRIMER

It is recommended that Tetrahydrofuran (THF) be used to prepare the surfaces of pipe and fittings for solvent welding. Do not use water, rags, gasoline or any other substitutes for cleaning PVC or CPVC surfaces. A chemical cleaner such as MEK may be used.

CEMENT

The cement should be a bodied cement of approximately 500 to 1600 centipoise viscosity containing 10-20% (by weight) virgin PVC material solvated with tetrahydrofuran (THF). Small quantities of dimethyl formamide (DMF) may be included to act as a retarding agent to extend curing time. Select the proper cement; Schedule 40 cement should be used for Schedule 40 pipe. Never use all-purpose cements, commercial glues and adhesives or ABS cement to join PVC or CPVC pipe and fittings.



⚠ WARNING

Fire Hazard

- Primers and cements are extremely flammable, and must not be stored or used near heat or open flame.
- Also, use only in a well ventilated area.

APPLICATORS

Select a suitable pure bristle type paint brush. Use a proper width brush or roller to apply the primer and cement (see chart below). Speedy application of cement is important due to its fast drying characteristics. IMPORTANT NOTE: A dauber type applicator should only be used on pipe sizes 2" and below. For larger diameter pipe, a brush or roller must be used.

RECOMMENDED BRUSH* SIZE FOR PRIMER AND CEMENT APPLICATIONS	
Nominal Pipe (IPS)	Size Brush Width (INS.)
2	1-1/2
3	1-1/2 - 2-1/2

*USE ONLY NATURAL BRISTLE

TABLE 1

3. MAKING THE JOINT

A. Cutting

Pipe must be squarely cut to allow for the proper interfacing of the pipe end and the fitting socket bottom. This can be accomplished with a miter box saw or wheel type cutter. Wheel type cutters are not generally recommended for larger diameters since they tend to flare the corner of the pipe end. If this type of cutter is used, the flare on the end must be completely removed.

NOTE: Power saws should be specifically designed to cut plastic pipe.

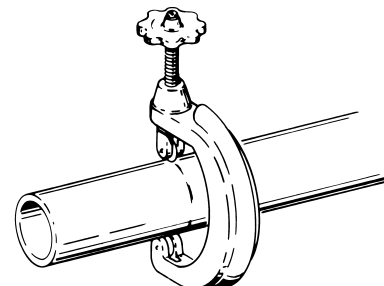

STEP A

B. Deburring

Use a knife, plastic pipe deburring tool, or file to remove burrs from the end of small diameter pipe. Be sure to remove all burrs from around the inside as well as the outside of the pipe. A slight chamfer (bevel) of about 10°-15° should be added to the end to permit easier insertion of the pipe into the end of the fitting. Failure to chamfer the edge of the pipe may remove cement from the fitting socket, causing the joint to leak.

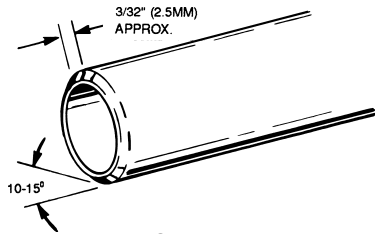

STEP B

C. Test dry fit of the joint

Tapered fitting sockets are designed so that an interfaced fit should occur when the pipe is inserted about 1/3 to 2/3 of the way into the socket. Occasionally, when pipe fitting dimensions are at the tolerance extremes, it will be possible to fully insert dry pipe to the bottom of the fitting socket. When this happens, a sufficient quantity of cement must be applied to the joint to fill the gap between the pipe and fitting. The gap must be filled to obtain a strong, leak-free joint.

D. Inspection, cleaning, priming

Visually inspect the inside of the pipe and fitting sockets and remove all dirt, grease or moisture with a clean dry rag. If wiping fails to clean the surfaces, a chemical cleaner must be used. Check for possible damage such as splits or cracks and replace if necessary.

Depth-of-entry

Marking the depth of entry is a way to check if the pipe has reached the bottom of the fitting socket in Step F. Measure the fitting depth and mark this distance on the pipe O.D. You may want to add several inches to the distance and make a second mark as the primer and cement will most likely destroy your first one.

Apply primer to the surface of the pipe and fitting socket with a natural bristle brush. This process softens and prepares the PVC or CPVC for the solvent cementing step. Move quickly and without hesitation to the cementing procedure while the surfaces are still wet with primer.

E. Application of solvent cement

- Apply the solvent cement evenly and quickly around the outside of the pipe at a width a little greater than the depth of the fitting socket.
- Apply a light coat of cement evenly around the inside of the fitting socket. Avoid puddling.
- Apply a second coat of cement to the pipe end.

	<h2>⚠ WARNING</h2> <ul style="list-style-type: none">• Cans of cement and primer should be closed at all times when not in use to prevent evaporation of chemicals and hardening of cement.• They are also very flammable and should be kept away from heat or flame.
---	--

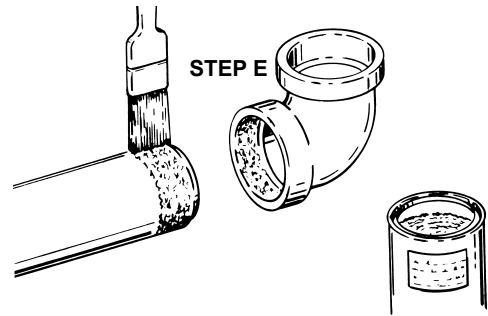

STEP E

F. Joint assembly

Working quickly, insert the pipe into the fitting socket bottom and give the pipe or fitting a 1/4 turn to evenly distribute the cement. Do not continue to rotate the pipe after it has hit the bottom of the fitting socket. A good joint will have sufficient cement to make a bead all the way around the outside of the fitting hub. The fitting will have a tendency to slide back while the cement is still wet so hold the joint together for about 15 seconds.

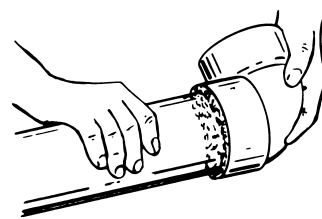

STEP F

G. Cleanup and joint movement

Remove all excess cement from around the pipe and fitting with a dry cotton rag. This must be done while the cement is still soft.

The joint should not be disturbed immediately after the cementing procedure, and sufficient time should be allowed for proper curing of the joint. Exact drying time is difficult to predict because it depends on variables such as temperature, humidity and cement integrity. For more specific information, you should contact your solvent cement manufacturer.

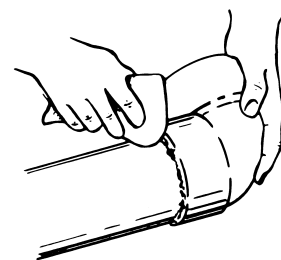

STEP G

FOR YOUR SAFETY READ BEFORE LIGHTING



WARNING: If you do not follow these instructions exactly, a fire or explosion may result causing property damage, personal injury or loss of life.



BEFORE OPERATING: ENTIRE SYSTEM MUST BE FILLED WITH WATER AND AIR PURGED FROM ALL LINES.

- A. This appliance does not have a pilot. It is equipped with an ignition device which automatically lights the burner. **Do not try to light the burner by hand.**
- B. **BEFORE OPERATING** smell all around the appliance area for gas. Be sure to smell next to the floor because some gas is heavier than air and will settle on the floor.
- WHAT TO DO IF YOU SMELL GAS:**
- Do not try to light any appliance.
 - Do not touch any electric switch; do not use any phone in your building.
 - Immediately call your gas supplier from a neighbor's phone. Follow the gas supplier's instructions.
- If you cannot reach your gas supplier, call the fire department.
- C. Use only your hand to push in the gas control buttons. Never use tools. If the control buttons will not push in, don't try to repair them, call a qualified service technician. Force or attempted repair may result in a fire or explosion.
- D. Do not use this appliance if any part has been under water. Immediately contact a qualified installer or service agency to replace a flooded water heater. Do not attempt to repair the unit. It must be replaced!

OPERATING INSTRUCTIONS

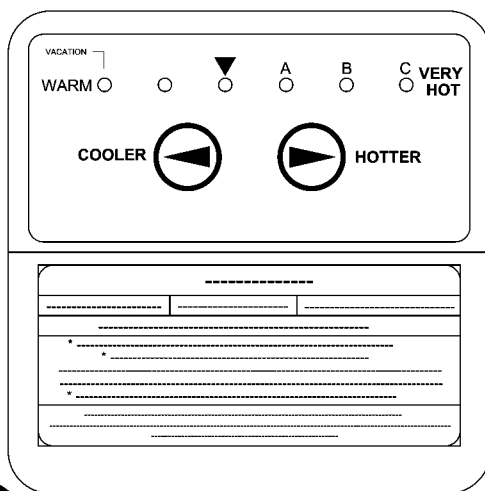

1. STOP! Read the safety information above on this label.
2. Set the ON/OFF switch on the control box to the "ON" position.
3. Set the thermostat to the lowest setting by first pressing the COOLER and HOTTER buttons together and holding for 1 second. Then press the COOLER button until the Warm indicator light appears.
4. Set the ON/OFF switch on the control box to the "OFF" position.
5. This appliance is equipped with a device which automatically lights the burner. **DO NOT TRY TO LIGHT THE BURNER BY HAND.**
6. Wait five (5) minutes to clear out any gas. If you then smell gas, STOP! Follow "B" in the safety information above on this label. If you don't smell gas, go to the next step.
7. Turn on all electrical power to the appliance.
8. Set the ON/OFF switch on the control box to the "ON" position.
9. Set the thermostat to the desired setting by first pressing the COOLER and HOTTER buttons together and holding for 1 second. Then press the HOTTER button .
10. WATER TEMPERATURE ADJUSTMENT is approximately 120°F.
 CAUTION: Hotter water increases the risk of scald injury. Consult the instruction manual before changing temperature.
11. If the appliance will not operate, follow the instructions "TO TURN OFF GAS TO APPLIANCE" and call your technician or gas supplier.
 WARNING: TURN OFF ALL ELECTRIC POWER BEFORE SERVICING.

TO TURN OFF GAS TO APPLIANCE

1. Set the thermostat to the lowest setting by first pressing the COOLER and HOTTER buttons together and holding for 1 second. Then press the COOLER button until the Warm indicator light appears.
2. Set the ON/OFF switch on the control box to the "OFF" position.
3. Turn off all electrical power to the appliance if service is to be performed.

TEMPERATURE REGULATION

Due to the nature of the typical gas water heater, the water temperature in certain situations may vary up to 30°F (16.7°C) higher or lower at the point of use such as, bathtubs, showers, sink, etc.

It is recommended that lower water temperatures be used to avoid the risk of scalding. It is further recommended, in all cases, that the water temperature be set for the lowest temperature which satisfies your hot water needs. This will also provide the most energy efficient operation of the water heater.

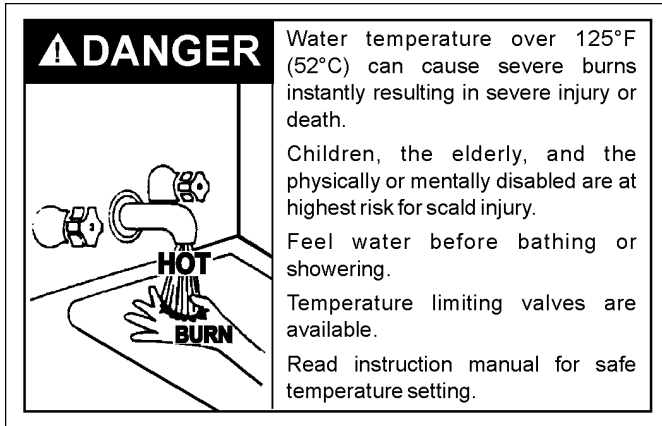

HOT WATER CAN SCALD: Water heaters are intended to produce hot water. Water heated to a temperature which will satisfy space heating, clothes washing, dish washing, and other sanitizing needs can scald and permanently injure you upon contact. Some people are more likely to be permanently injured by hot water than others. These include the elderly, children, the infirm, or physically/mentally handicapped. If anyone using hot water in your home fits into one of these groups or if there is a local code or state law requiring a certain temperature water at the hot water tap, then you must take special precautions. In addition to using the lowest possible temperature setting that satisfies your hot water needs, a means such as a mixing valve should be used at the hot water taps used by these people or at the water heater. Mixing valves are available at plumbing supply or hardware stores, see Figure 2. Follow manufacturer's instructions for installation of the valves. Before changing the factory setting on the thermostat see Figure 19.

Never allow small children to use a hot water tap, or to draw their own bath water. Never leave a child or handicapped person unattended in a bathtub or shower.

The water heater should be located in an area where the general public does not have access. If a suitable area is not available, a cover should be installed over the thermostat to prevent tampering.

The water temperature setting was factory set at the lowest temperature; Pressing the "COOLER" button decreases temperature and pressing the "HOTTER" button increases the temperature.

Setting the water heater temperature at 120°F (49°C) (Approx. "▼" mark on temperature setting of the gas control valve) will reduce the risks of scalds. Some states require settings at specific lower temperatures.

To avoid any unintentional changes in water temperature settings, the

control has a tamper resistant feature for changing the temperature setting. To change the temperature setting follow these instructions:

1. "Wake Up" the temperature indicators by holding down both "COOLER" and "HOTTER" temperature adjustment buttons at the same time for one second, see Figure 19. One or two of the temperature indicators will light up. These indicators will only remain on for 30 seconds if no further buttons are pressed. After 30 seconds the control will go back to "Sleep" mode.

2. Release both of the temperature adjustment buttons.

- a. To decrease the temperature press and release the "COOLER" button until the desired setting is reached.

- b. To increase the temperature press and release the "HOTTER" button until the desired setting is reached.

NOTE: Holding down the button will not continue to lower or raise the temperature setting. The button must be pressed and released for each temperature change desired.

Should overheating occur or the gas supply fail to shut off, turn off the manual gas control valve to the appliance.

GAS CONTROL VALVE - FRONT VIEW

TEMPERATURE INDICATORS

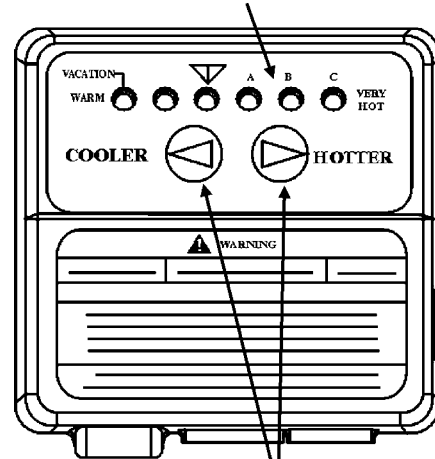

TEMPERATURE ADJUSTMENT BUTTONS

Temperature Setting	Display ▼ A B C	Time to Produce 2nd and 3rd Degree Burns on Adult Skin
C-Flashing = approx. 160°F (71°C)	○○○○○●	About 1/2 seconds
C = approx. 150°F (66°C)	○○○○○●	About 1-1/2 seconds
B = approx. 140°F (60°C)	○○○○●○	Less than 5 seconds
A = approx. 130°F (54°C)	○○○●○○	About 30 seconds
▼ = approx. 120°F (49°C)	○○●○○○	More than 5 minutes
WARM = approx. 80°F (27°C)	●○○○○○	-----

FIGURE 19.

FOR YOUR INFORMATION

START UP CONDITIONS

CONDENSATE

Whenever the water heater is filled with cold water, some condensate will form while the burner is on. A water heater may appear to be leaking when in fact the water is condensate. This usually happens when:

- A new water heater is filled with cold water for the first time.
- Burning gas produces water vapor in water heaters, particularly high efficiency models where flue temperatures are lower.
- Large amounts of hot water are used in a short time and the refill water in the tank is very cold.

Moisture from the products of combustion condense on the cooler tank surfaces and form drops of water which may fall onto the burner or other hot surfaces to produce a “sizzling” or “frying” noise.

Because of the suddenness and amount of water, condensate water may be diagnosed as a “tank leak”. After the water in the tank warms up (about 1-2 hours), the condition should disappear.

Do not assume the water heater is leaking until there has been enough time for the water in the tank to warm up.

An undersized water heater will cause more condensation. The water heater must be sized properly to meet the family’s demands for hot water including dishwashers, washing machines and shower heads.

Excessive condensate may be noticed during the winter and early spring months when incoming water temperatures are at their lowest.

Good venting is essential for a gas fired water heater to operate properly as well as to carry away products of combustion and water vapor.

SMOKE/ODOR

It is not uncommon to experience a small amount of smoke and odor during the initial start-up. This is due to burning off of oil from metal parts, and will disappear in a short while.

THERMAL EXPANSION



CLOSED WATER SYSTEMS

Water supply systems may, because of code requirements or such conditions as high line pressure, among others, have installed devices such as pressure reducing valves, check valves, and back flow preventers. Devices such as these cause the water system to be a closed system.

THERMAL EXPANSION

As water is heated, it expands (thermal expansion). In a closed system the volume of water will grow. As the volume of water grows there will be a corresponding increase in water pressure due to thermal expansion. Thermal expansion can cause premature tank failure (leakage). This type of failure is not covered under the limited warranty. Thermal expansion can also cause intermittent temperature-pressure relief valve operation: water discharged from the valve due to excessive pressure build up. The temperature-pressure relief valve is not intended for the constant relief of thermal expansion. This condition is not covered under the limited warranty.

A properly sized thermal expansion tank should be installed on all closed systems to control the harmful effects of thermal expansion. Contact a local plumbing service agency to have a thermal expansion tank installed.

STRANGE SOUNDS

Possible noises due to expansion and contraction of some metal parts during periods of heat-up and cool-down do not necessarily represent harmful or dangerous conditions.

Condensation causes sizzling and popping within the burner area during heating and cooling periods and should be considered normal. See “Condensate” in this section.

OPERATIONAL CONDITIONS

SMELLY WATER

In each water heater there is installed at least one anode rod (see parts section) for corrosion protection of the tank. Certain water conditions will cause a reaction between this rod and the water. The most common complaint associated with the anode rod is one of a “rotten egg smell” in the hot water. The smell is a result of four factors which must all be present for the odor to develop:

- A concentration of sulfate in the supply water.
- Little or no dissolved oxygen in the water.
- A sulfate reducing bacteria which has accumulated within the water heater (this harmless bacteria is nontoxic to humans).
- An excess of active hydrogen in the tank. This is caused by the corrosion protective action of the anode.

Smelly water may be eliminated or reduced in some water heater models by replacing the anode(s) with one of less active material, and then chlorinating the water heater tank and all water lines. Contact the local water heater supplier or service agency for further information concerning an Anode Replacement Kit and this chlorination treatment.

If the smelly water persists after the anode replacement and chlorination treatment, we can only suggest that chlorination or aeration of the water supply be considered to eliminate the water problem.

Do not remove the anode leaving the tank unprotected. By doing so, all warranty on the water heater tank is voided.

“AIR” IN HOT WATER FAUCETS

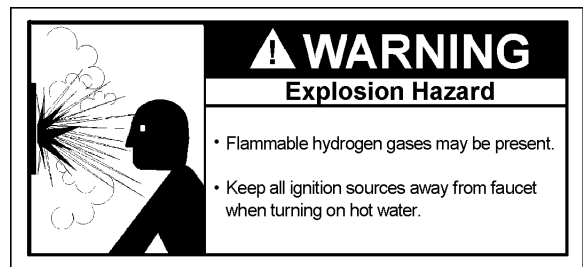

HYDROGEN GAS: Hydrogen gas can be produced in a hot water system that has not been used for a long period of time (generally two weeks or more). Hydrogen gas is extremely flammable and explosive. To prevent the possibility of injury under these conditions, we recommend the hot water faucet, located farthest away, be opened for several minutes before any electrical appliances which are connected to the hot water system are used (such as a dishwasher or washing machine). If hydrogen gas is present, there will probably be an unusual sound similar to air escaping through the pipe as the hot water faucet is opened. There must be no smoking or open flame near the faucet at the time it is open.

HIGH WATER TEMPERATURE SHUT OFF SYSTEM

This water heater is equipped with an automatic gas shut-off system. This system works when high water temperatures are present. Turn “OFF” the entire gas supply to the water heater. The high temperature shut-off is built into the gas control valve. It is non-resettable. If the high temperature shut-off activates, the gas control valve must be replaced. Contact your gas supplier or service agency.

PERIODIC MAINTENANCE

VENTING SYSTEM INSPECTION

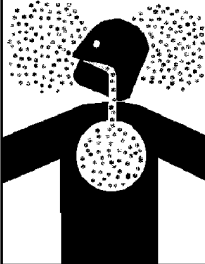
⚠ WARNING	
Breathing Hazard - Carbon Monoxide Gas	
	<ul style="list-style-type: none">• Flue gases may escape if vent pipe is not connected.• Be alert for obstructed, sooted or deteriorated vent system to avoid serious injury or death.• Do not store corrosive chemicals in vicinity of water heater.• Chemical corrosion of flue and vent system can cause serious injury or death.
Breathing carbon monoxide can cause brain damage or death. Always read and understand instruction manual.	

At least once a year a visual inspection should be made of the venting system. You should look for:

1. Obstructions which could cause improper venting. The combustion and ventilation air flow must not be obstructed.
2. Damage or deterioration which could cause improper venting or leakage of combustion products.

Be sure the vent piping is properly connected to prevent escape of dangerous flue gasses which could cause deadly asphyxiation.

Obstructions and deteriorated vent systems may present serious health risk or asphyxiation.

Chemical vapor corrosion of the flue and vent system may occur if air for combustion contains certain chemical vapors. Spray can propellants, cleaning solvents, refrigerator and air conditioner refrigerants, swimming pool chemicals, calcium and sodium chloride, waxes, bleach and process chemicals are typical compounds which are potentially corrosive.

If after inspection of the vent system you found sooting or deterioration, something is wrong. Call the local gas utility to correct the problem and clean or replace the flue and venting before resuming operation of the water heater.

BURNER OPERATION AND INSPECTION

Flood damage to a water heater may not be readily visible or immediately detectable. However, over a period of time a flooded water heater will create dangerous conditions which can cause DEATH, SERIOUS BODILY INJURY, OR PROPERTY DAMAGE. Contact a qualified installer or service agency to replace a flooded water heater. Do not attempt to repair the unit! It must be replaced!

At least once a year a visual inspection should be made of the main burner and the hot surface igniter assembly for proper flame characteristics and ignition sequences. This can be done by removing the Outer Door and viewing the main burner operation through the Viewport on the Inner Door, see Figure 1. The main burner should provide complete combustion of gas, ignite rapidly, give reasonably quiet operation, and cause no excessive flame lifting from the burner ports. If the proper flame characteristics are not evident (see Figure 20), make sure that the flow of combustion and ventilation air is not blocked on the Air Intake Screen at the base of the water heater (see Figure 21), the Lint screen on the blower assembly (see Figure 1), and in the venting system.

You should also check for sooting. Soot is not normal and will impair

proper combustion. A visual inspection of the main burner and HSI igniter assembly should also be done at least once a year, see Figure 20.

Soot build-up indicates a problem that requires correction before further use. Turn "OFF" gas to water heater and leave off until repairs are made, because failure to correct the cause of the sooting can result in a fire causing death, serious injury, or property damage.



FIGURE 20.

BURNER CLEANING

In the event your burner or burner air openings require cleaning, turn the blower switch to the "OFF" position and allow the burner to cool. Call a service agency to remove and clean the burner and correct the problem that required the burner to be cleaned.

HOUSEKEEPING

Vacuum around base of water heater for dust, dirt, and lint on a regular basis.

	⚠ DANGER
	Fire and Explosion Hazard
	<ul style="list-style-type: none">• Do not obstruct combustion air openings at the bottom of the water heater.• Do not use or store flammable vapor products such as gasoline, solvents or adhesives in the same room or area near water heater or other appliance.• Visibly inspect air intake screen at least once every six months and clean if accumulated lint.• Can cause serious injury or death.

This water heater unit is supplied with a plastic Air Intake Screen that will filter and prevent lint build-up on the bottom of the flame arrestor of this heater. To prevent the lint build-up on the arrestor, the lint screen must be installed on the Base Pan with the "arrows" pointing upwards as shown in Figure 21. If the Air Intake Screen is missing from this heater, please contact your service agency or local installer for a replacement part.

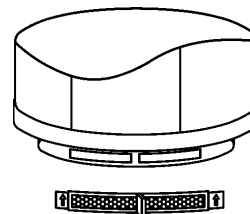

FIGURE 21.

AT LEAST ONCE EVERY SIX MONTHS A VISUAL INSPECTION SHOULD BE MADE OF THE AIR INTAKE SCREENS ON THE BASE OF THE WATER HEATER AND THE BLOWER ASSEMBLY. CLEAN IF LINT ACCUMULATIONS ARE NOTICED.

INSTALLED IN SUITABLE AREA: To insure sufficient ventilation and combustion air supply, proper clearances from the water heater must be maintained. See “Locating the New Water Heater” section. Combustible materials such as clothing, cleaning materials, or flammable liquids, etc. must not be placed against or adjacent to the water heater which can cause a fire.

ANODE ROD INSPECTION

CAUTION
Property Damage Hazard
<ul style="list-style-type: none"> • Avoid water heater damage. • Inspection and replacement of anode rod required.

The anode rod is used to protect the tank from corrosion. Most hot water tanks are equipped with an anode rod. The submerged rod sacrifices itself to protect the tank. Instead of corroding the tank, water ions attack and eat away the anode rod. This does not affect the water’s taste or color. The rod must be maintained to keep the tank in operating condition.

Anode deterioration depends on water conductivity, not necessarily water condition. A corroded or pitted anode rod indicates high water conductivity and should be checked and/or replaced more often than an anode rod that appears to be intact. Replacement of a depleted anode rod can extend the life of your water heater. Inspection should be conducted by a qualified technician, and at a minimum should be checked annually after the warranty period.

TEMPERATURE-PRESSURE RELIEF VALVE OPERATION

▲ DANGER	<ul style="list-style-type: none"> • Burn hazard. • Hot water discharge. • Keep clear of relief valve discharge outlet.

The temperature-pressure relief valve must be manually operated at least once a year.

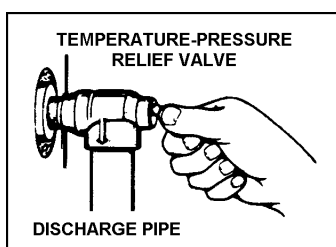

FIGURE 22.

When checking the temperature-pressure relief valve operation, make sure that (1) no one is in front of or around the outlet of the temperature-pressure relief valve discharge line, and (2) that the water discharge will not cause any property damage, as the water may be extremely hot, see Figure 22.

If after manually operating the valve, it fails to completely reset and

continues to release water, immediately close the cold water inlet to the water heater, follow the draining instructions, and replace the temperature-pressure relief valve with a new one.

If the temperature-pressure relief valve on the appliance weeps or discharges periodically, this may be due to thermal expansion. You may have a check valve installed in the water line or a water meter with a check valve. Consult your local water supplier or service agency for further information. Do not plug the temperature-pressure relief valve.

DRAINING

▲ DANGER	<ul style="list-style-type: none"> • Burn hazard. • Hot water discharge. • Keep hands clear of drain valve discharge.

The water heater should be drained if being shut down during freezing temperatures. Also periodic draining and cleaning of sediment from the tank may be necessary.

1. Set the blower switch to the “OFF” position and turn electrical power off to blower.
2. Turn off the gas to the water heater at the manual gas shut-off valve.
3. OPEN a nearby hot water faucet until the water is no longer hot.
4. CLOSE the cold water inlet valve.
5. Connect a hose to the drain valve and terminate it to an adequate drain or external to the building.
6. OPEN the water heater drain valve to allow all of the water to drain from the tank. Flush the tank with water as needed to remove sediment.

NOTE: If the water heater is going to be shut down and drained for an extended period, the drain valve should be left open with hose connected allowing water to terminate to an adequate drain.

7. Close the drain valve, refill the tank, and restart the heater as directed in this manual.
8. Follow instructions in the “Filling The Water Heater” section.
9. Follow the lighting instructions on the label or see page 21 under “Lighting Instructions” to restart the water heater.

DRAIN VALVE WASHER REPLACEMENT

(See Figure 23)

1. Turn “OFF” gas supply to water heater.
2. Follow “Draining” instructions.
3. Turning counterclockwise (↺), remove the hex cap below the screw handle.
4. Remove the washer and put the new one in place.
5. Screw the handle and cap assembly back into the drain valve and retighten using a wrench. DO NOT OVER TIGHTEN.
6. Follow instructions in the “Filling The Water Heater” section.
7. Check for leaks.

8. Follow the lighting instructions in the "Lighting" section to restart the water heater.

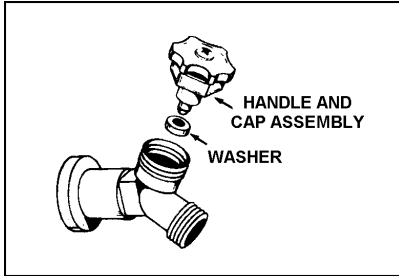

FIGURE 23.

SERVICE

If a condition persists or you are uncertain about the operation of the water heater contact a service agency.

Use this guide to check a "Leaking" water heater. Many suspected "Leakers" are not leaking tanks. Often the source of the water can be found and corrected.

If you are not thoroughly familiar with gas codes, your water heater, and safety practices, contact your gas supplier or qualified installer to check the water heater.

LEAKAGE CHECKPOINTS

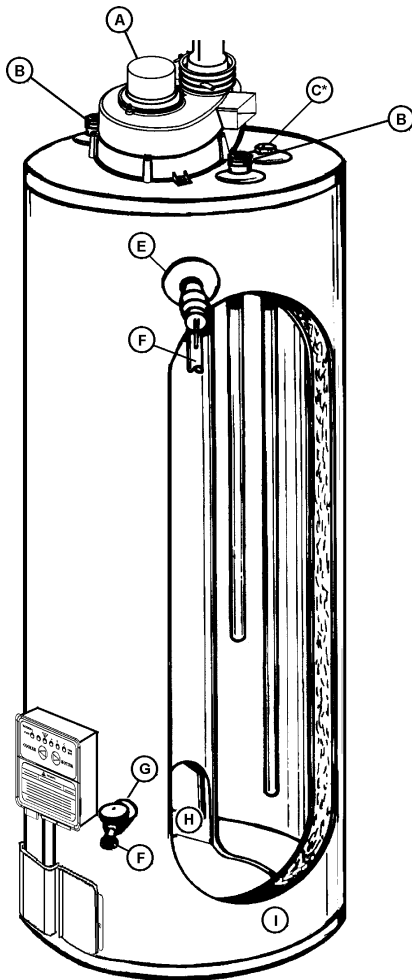

Read this manual first. Then before checking the water heater make sure the gas supply has been turned "OFF", and never turn the gas "ON" before the tank is completely full of water.

Never use this water heater unless it is completely filled with water. To prevent damage to the tank, the tank must be filled with water. Water must flow from the hot water faucet before turning "ON" gas to the water heater.

- A. Water at the blower assembly is water vapor which has condensed out of the combustion products. This is caused by a problem in the vent. Contact the gas utility.
- B. *Condensation may be seen on pipes in humid weather or pipe connections may be leaking.
- C. *The anode rod fitting may be leaking (anode is located under the Blower Assembly).
- D. Small amounts of water from temperature-pressure relief valve may be due to thermal expansion or high water pressure in your area.
- E. *The temperature-pressure relief valve may be leaking at the tank fitting.
- F. Water from a drain valve may be due to the valve being slightly opened.
- G. *The drain valve may be leaking at the tank fitting.
- H. Combustion products contain water vapor which can condense on the cooler surfaces of the tank. Droplets form and drip onto the burner or run on the floor. This is common at the time of start-up after installation and when incoming water is cold.
- I. Water in the water heater bottom or on the floor may be from condensation, loose connections, or the relief valve. DO NOT replace the water heater until a full inspection of all possible water sources is made and necessary corrective steps taken.

Leakage from other appliances, water lines, or ground seepage should also be checked.

- * To check where threaded portion enters tank, insert cotton swab between jacket opening and fitting. If cotton is wet, follow "Draining" instructions in the "Periodic Maintenance" section and then remove fitting. Put pipe dope or teflon tape on the threads and replace. Then follow "Filling the Water Heater" instructions in the "Installing the New Water Heater" section.



⚠ WARNING

Read and understand instruction manual and safety messages before installing, operating or servicing this water heater.

Failure to follow instructions and safety messages could result in death or serious injury.

Instruction Manual must remain with water heater.

REPAIR PARTS LIST

Key No.	Part Description
1	Burner Assembly
2	Burner Head
3	Burner Orifice
4	Burner Tube
5	HSI Ignition Assembly
6	Inner Door
7	Inner Door Gasket
8	Flue Baffle
9	Flue Restrictor
10	Blower Assembly
11	Air Intake Screen - Base Pan
12	Inlet Tube
13	Gas Control Valve Thermostat
14	Drain Valve
15	Drain Valve Washer
16	Outer Door (may appear different than shown)
17	Anode Rod
18	Temperature-Pressure Relief Valve
19	Viewport Bracket
20	Viewport Glass
21	Viewport Insulation
22	20" Dia. Metal Drain Pan w/Side Drain (optional)
	22" Dia. Metal Drain Pan w/Side Drain (optional)
	24" Dia. Metal Drain Pan w/Side Drain (optional)
	26" Dia. Metal Drain Pan w/Side Drain (optional)
*23	Instruction Manual
24	Air Intake Screen - Blower Assembly
25	FV Sensor
26A	FV Sensor Bracket (40K & 50K models only)
26B	FV Sensor Bracket (55K & 62.5K models only)
**27	Nipple with Heat Trap
**28	Secondary Anode with Heat Trap

* Not Shown.

** Optional

Now that you have purchased this water heater, should a need ever exist for repair parts or service, simply contact the company it was purchased from or direct from the manufacturer listed on the rating plate on the water heater.

Be sure to provide all pertinent facts when you call or visit.

Selling prices will be furnished on request or parts will be shipped at prevailing prices and you will be billed accordingly.

The model number of your Gas Water Heater will be found on the rating place located above the gas control valve.

WHEN ORDERING REPAIR PARTS, ALWAYS GIVE THE FOLLOWING INFORMATION:

- MODEL NUMBER
- TYPE GAS (NATURAL OR PROPANE (L.P.))
- SERIAL NUMBER
- PART DESCRIPTION



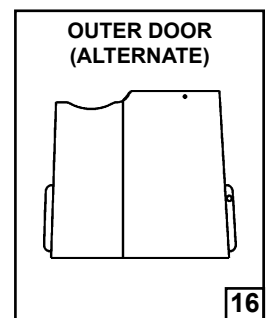
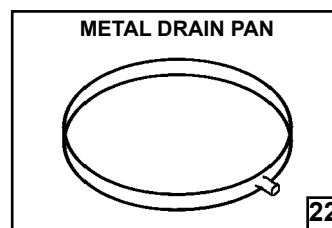
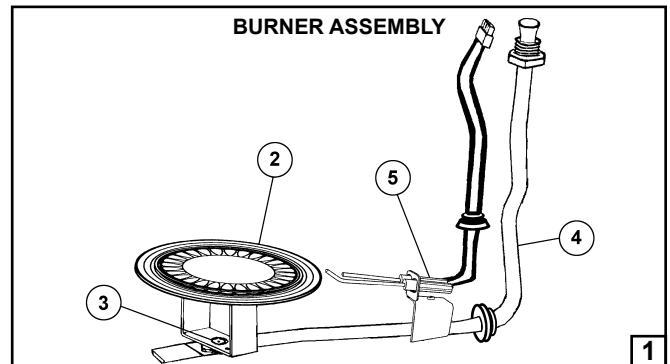
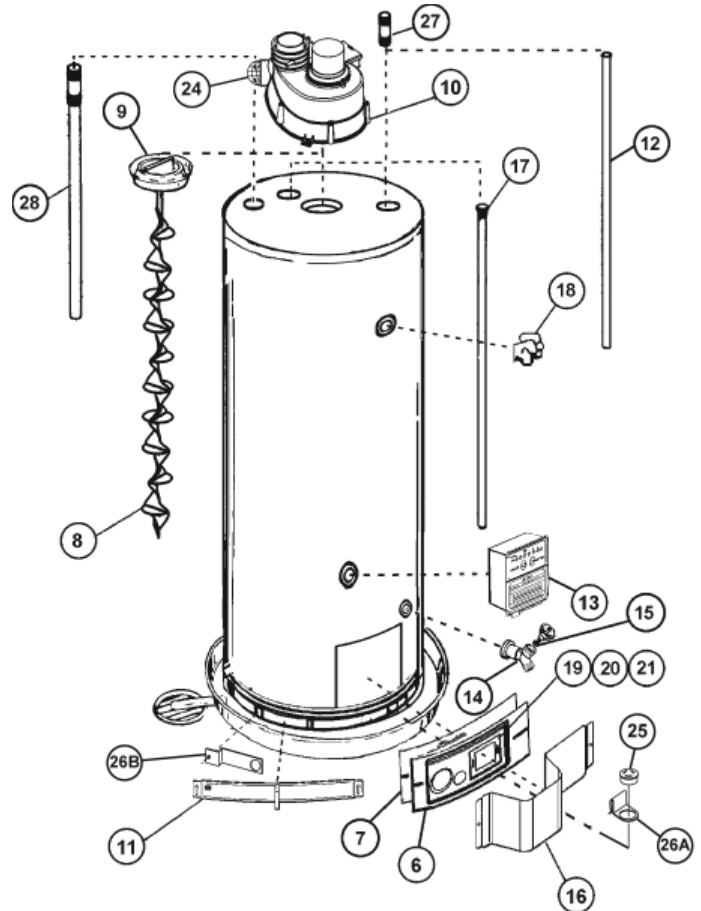



THIS IS A REPAIR PARTS LIST, NOT A PACKING LIST.













TROUBLESHOOTING GUIDELINES

TROUBLE SHOOTING

Please check guidelines below. For your safety, water heater service should be performed only by a qualified service technician. Read the GENERAL SAFETY INFORMATION section first.

#	LED STATUS	PROBLEM	SOLUTION
1		Inadequate or no earth ground.	<ol style="list-style-type: none"> 1 Ensure the wall outlet (power supply) is properly grounded. 2 Ensure all ground connections/wires on the water heater are securely connected.
2		High resistance to earth ground or reversed polarity in the 120 VAC power supply.	<ol style="list-style-type: none"> 1 Ensure that the water heater is securely connected to earth ground. 2 Ensure that the wall outlet/power supply is properly wired. Also, ensure that internal 120 VAC wiring connections and the wiring harness have no reversed wires. 120 VAC "hot" wire must connect to the on/off switch.
3		<p>Pressure switch circuit remaining closed for more than 5 seconds after heating cycle begins.</p> <p>Blower may not start in this condition.</p>	<ol style="list-style-type: none"> 1 Ensure air pressure switch circuit wiring is correct and the air pressure switch is not jumpered. 2 Replace the air pressure switch.
4		<p>Pressure switch circuit remains open longer than 5 seconds after the blower is energized.</p> <p>Blower may run continuously in this condition.</p>	<ol style="list-style-type: none"> 1 Ensure the air pressure switch sensing tube is properly connected at both ends and is not kinked or damaged. 2 Ensure the correct size of vent and intake air pipe (direct vent products) was used per the installation instructions that came with the water heater. 3 Ensure the maximum number of elbows or maximum equivalent feet of vent or intake air pipe have not been exceeded per the installation instructions that came with the water heater. 4 Ensure there are no obstructions in the vent or intake air pipe.
5		Open igniter circuit.	<ol style="list-style-type: none"> 1 Check wiring to the hot surface igniter assembly - replace igniter assembly if wiring is damaged or worn. 2 Check resistance of the igniter at igniter assembly plug - should be between 11 and 18 ohms at room temperature (77° F at plug end) - replace igniter if open or shorted. 3 Check igniter assembly plug and the socket on the gas control valve/thermostat for good connection. Replace igniter assembly if the plug is worn or damaged. 4 Replace the gas control valve/thermostat if the igniter assembly socket on the bottom of the control is worn or damaged.
6		<p>Ignition/flame failure.</p> <p>The gas control valve/thermostat has reached the maximum number of retries (3) for ignition and is currently locked out for one hour.</p> <p>Cycle the power to the water heater off and on to reset.</p>	<ol style="list-style-type: none"> 1 Ensure flame sensor is making good contact with the burner flame and ensure flame is steady. Also ensure supply and manifold gas pressures are within the requirements in the installation manual. 2 Gas supply is turned off or gas pressure is too low. For low gas pressure, consult with your gas utility. 3 Ensure the flame sensor is clean - use fine steel wool to clean the flame sensor. 4 Check igniter assembly plug and the socket on the bottom of the gas control valve/thermostat for good connection. Replace igniter assembly if the plug is worn or damaged. Replace the gas control valve/thermostat if socket is worn or damaged. 5 Replace igniter assembly.

#	LED STATUS	PROBLEM	SOLUTION
7		Self diagnostic check has detected a problem with the gas valve driver circuit, internal microprocessor, or other internal circuits.	<ol style="list-style-type: none"> 1 Turn the power off for 10-20 seconds, then on again to clear these error codes. 2 If any of these error codes persist or cannot be cleared, replace the gas control valve/thermostat.
8			
9			
10		Flame signal sensed out of proper sequence.	<ol style="list-style-type: none"> 1 Turn the power off for 10-20 seconds, then on again to clear these error codes. 2 Replace the gas control valve/thermostat if this error code persists.
11		Water in the tank has exceeded the maximum allowable temperature, activating the ECO (energy cut off).	<ol style="list-style-type: none"> 1 Turn the power off for 10-20 seconds, then on again to clear these error codes. 2 Replace the gas control valve/thermostat if the error code persists.
12		One or both of the temperature adjust buttons are stuck.	<ol style="list-style-type: none"> 1 Press and release both temperature adjust buttons several times - cycle water heater power off and on. 2 Replace the gas control valve/thermostat if the error code persists.
13		The water temperature sensor (located in the control valve's immersion probe) is either open or shorted.	<ol style="list-style-type: none"> 1 Turn the power off for 10-20 seconds, then on again to clear these error codes. 2 Replace the gas control valve/thermostat if the error code persists.
14		The FV (flammable vapor) sensor is either open or shorted.	<ol style="list-style-type: none"> 1 Turn off power to the water heater. Ensure all FV sensor wiring, the ignitor assembly plug, and the ignitor assembly socket on the bottom of the Intelli-Vent control are making good contact. Repair or replace any worn/damaged components that are not making good connection. 2 Replace the FV sensor.
15		Self diagnostic check has detected the presence of flammable vapors from the FV (flammable vapor) sensor.	<ol style="list-style-type: none"> 1 Do not touch any electrical switch, do not use any phone in your building, and do not try to light any appliance. 2 Smell around the water heater to ensure there are no gas leaks at the gas control valve/thermostat, in the supply gas line(s), or any other type of flammable vapor(s) in the area. 3 Carefully inspect the area surrounding the water heater for any substances such as gasoline, paint, paint thinners, varnish, or cleaners that could emit flammable vapors. Remove anything that can potentially emit flammable vapors from the area and store it properly in a different location. 4 Call the technical information support phone number shown on the water heater labeling for further assistance.
16		<p>Air pressure switch circuit is opening repeatedly during one heating cycle.</p> <p>LDO (Lint, Dust, and Oil) lockout condition.</p>	<ol style="list-style-type: none"> 1 On models equipped with a dilution air intake screen on the blower assembly - check/clean the screen. 2 On models equipped with a combustion air intake screen on the base ring (bottom) of the water heater - check/clean the screen. 3 Ensure intake air screen(s) on models so equipped are not obstructed.

TROUBLESHOOTING GUIDELINES

These guidelines should be utilized by a qualified service agent. When calling for service notify the service agent that this is a "Flammable Vapor Ignition Resistant" Product.

PROBLEM	CAUSE	SOLUTION
NOT ENOUGH HOT WATER	1.) Blower will not run.	
	a. "ON/OFF" control switch turned off.	Turn switch to the "ON" position.
	b. Blower unplugged.	Plug blower back into 115 VAC outlet.
	c. No power at outlet.	Repair service to outlet.
	d. Thermostat defective.	Replace thermostat.
	e. Control harness defective.	Replace control harness.
	f. High limit control circuit open.	Replace thermostat.
	g. Blower motor defective.	Replace blower assembly.
	2.) Thermostat problems	
	a. Thermostat set too low.	Adjust temperature control higher.
	b. Thermostat or ECO defective.	Replace thermostat.
	3.) Others	
	a. Heater undersized.	Reduce hot water use.
	b. Low gas pressure.	Contact dealer.
	c. Incoming water is usually cold.	Allow more time for heater to reheat.
d. Leaking hot water pipes of fixtures.	Have plumber check and repair leaks.	
e. Heater not lit or thermostat not on.	Refer to LIGHTING INSTRUCTIONS.	
VENT PIPE TOO HOT (ABOVE 170°F)	Defective air flow restrictor.	Take unit out of service immediately; contact a service agency to determine cause.
	Not enough dilution air to mix with flue gases.	Proper dilution air must be provided for combustion and dilution of flue temp. Refer to INSTALLATION section.
	Dilution air too hot for mixing with flue gases.	Supply air is too hot. Check for heat sources around and/or blockage of dilution air intake.
	Wrong burner orifice.	Install correct orifice.
YELLOW FLAME	Dirt in burner ports.	Turn off heater and gas, clean burner head.
	Combustion air path restricted.	Check dilution air intake, exhaust venting, and air openings in bottom base pan for obstructions or blockage.
	Not enough dilution air for proper combustion.	Check dilution air intake for obstructions or blockage.
CONDENSATION	Water on the floor under heater.	See CONDENSATION section.
	Water dripping from blower assembly.	Provide drip "TEE" to catch condensation, see Figure 1.
WATER LEAKS	Improperly sealed, hot or cold supply connections, relief valve, drain valve, or thermostat threads.	Tighten threaded connections. Remove cap on Rubber Boot Vent Terminal of Blower Assembly and install a drain tube to port as per required codes, see Figure 1 and 15.
	Leakage from other appliances or water lines.	Inspect other appliances near water heater.
	Condensation of flue products.	Refer to CONDENSATION section.
LEAKING T & P	Condensation of flue products.	Refer to CONDENSATION section.
	Thermal expansion in closed water system.	Install thermal expansion tank (Do not plug T & P valve).
	Improperly seated valve.	Check relief valve for proper operation (Do not plug T & P valve).
HOT WATER ODORS (refer to cathodic protection)	High sulfate or mineral content in water supply.	Drain and flush heater thoroughly then refill.
	Bacteria in water supply	Chlorinate water supply.
WATER TOO HOT	Thermostat set too high.	Refer to HIGH TEMPERATURE REGULATION section.
WATER HEATER SOUNDS	Condensation dripping on burner.	Refer to CONDENSATION above.
SIZZLING – RUMBLING	Sediment at bottom of heater tank.	Clean sediment from tank. Refer to DRAINING.
SOOTING	Improper combustion.	Refer to Air Requirements on Page 9.
BURNER WILL NOT STAY LIT – GOES OUT 4-5 SECONDS	Outlet polarity is reversed.	Test polarity and correct.
	High ambient room temperature.	Contact a service agency to determine cause.
	Dirty or clogged air intake screen (at base of heater).	Clean and reinstall air intake screen.
	Dirty or clogged lint screen (on blower assembly).	Clean and reinstall lint screen.
	Flame arrestor opening blocked.	Contact a service agency to determine cause.
VENT GAS ODORS	Defective gas valve.	Replace gas valve.
	Lack of air supply.	Contact a service agency to determine cause.
	Improperly installed vent piping.	
	Downdraft	
Poor combustion		

LIMITED RESIDENTIAL GAS WARRANTY

THIS WARRANTY IS APPLICABLE TO THE ORIGINAL OWNER ONLY. If the glass lined tank in this water heater shall prove upon examination by (the warrantor) to have leaked during the warranty period in normal residential use, due to natural corrosion from potable water therein, the warrantor will furnish the ORIGINAL OWNER a replacement water heater of equivalent size and current model, or a replacement part for any component part which fails in normal use, in accordance with the warranty terms and conditions specified below. THE WATER HEATER REPLACEMENT MODEL OR PART WILL BE WARRANTED FOR ONLY THE UNEXPIRED PORTION OF THE ORIGINAL WARRANTY. The warranty period will be determined by the original installation date of the water heater. PROOF-OF-PURCHASE AND PROOF-OF-INSTALLATION ARE NECESSARY TO VALIDATE THIS WARRANTY. This warranty is not transferable.

WARRANTY PERIOD		
Product Line	TANK ¹	PARTS ²
606, (6/A6), GS6, GPVH, GPVR, GPVT, GPVX	6 YEARS	6 YEARS
805 (8)	8 YEARS	6 YEARS
A10	10 YEARS	6 YEARS

When the water heater has been used for other than single family residential application: 1. The Tank warranty shall be reduced to 3 years on 10 year models and 1 year on 6 and 8 year models. 2. The parts warranty shall be reduced to 1 year for all models. Returned parts which meet any of the following conditions are not covered by this warranty: 1) improper installation or removal; 2) damaged by other than normal wear; 3) replaced for cosmetic purposes; or 4) returned with defaced date codes.

CONDITIONS AND EXCEPTIONS

This warranty shall apply only when the water heater is installed and operated in accordance with: 1) all local fire codes and plumbing codes, ordinances and regulations; 2) the printed instructions provided with it; 3) good industry practices; and 4) proper safety practices such as but not limited to a properly sized suitable metal drain pan if installed in an area where leakage from connections of the tank would result in damage to the area adjacent to the heater. In addition, a new temperature and pressure relief valve, certified by the Canadian Standards Association must have been properly installed and piped to the nearest drain.

This warranty shall apply only when the heater is:

- owned by the original purchaser;
- used at temperatures not exceeding the maximum calibrated setting of its thermostat;
- not subjected to excessive water pressure fluctuations and not subject to an operating pressure greater than 150 P.S.I.;
- filled with potable water, free to circulate at all times and with the tank free of damaging water sediment or scale deposits;
- used in a non-corrosive and non-contaminated atmosphere;
- used with factory approved anode(s) installed;
- in its original installation location;
- in the United States and its territories or possessions;
- sized in accordance with proper sizing techniques for residential water heaters;
- bearing a rating plate which has not been altered, defaced or removed except as required by the warrantor;
- used in an open system or in a closed system with a properly sized and installed thermal expansion tank;
- fired at the factory rated input using the fuel stated in the face of the rating plate;
- operated with the inner and outer combustion chamber doors in place;
- maintained in accordance with the instructions printed in the manual included with the heater.

Any accident to the water heater or any part thereof (including freezing, fire, floods, or lightning), any misuse, abuse or alteration of it, any operation of it in a modified form, or any attempt to repair tank leaks or parts, will void this warranty.

SERVICE AND LABOR RESPONSIBILITY

UNDER THIS LIMITED WARRANTY, THE WARRANTOR WILL PROVIDE ONLY A REPLACEMENT WATER HEATER OR PART THEREOF. THE OWNER IS RESPONSIBLE FOR ALL OTHER COSTS. Such costs may include but are not limited to:

- Labor charges for service, removal, or reinstallation of the water heater

or part thereof.

- Shipping and delivery charges for forwarding the new water heater or replacement part from the nearest distributor and returning the claimed defective heater or part to such distributor except in the state of California where such charges are the manufacturer's responsibility.
- All cost necessary or incidental for handling and administrative charges, and for any materials and/or permits required for installation of the replacement heater or part.

LIMITATION ON IMPLIED WARRANTIES

Implied warranties, including any warranty of merchantability imposed on the sale of this heater under state law are limited to one year duration for the heater or any of its parts. Some states do not allow limitations on how long an implied warranty lasts, so the above limitations may not apply to you.

CLAIM PROCEDURE

Any claim under this warranty should be initiated with the dealer who sold the heater, or with any other dealer handling the warrantor's products.

The warrantor will only honor replacement with identical or similar water heater or parts thereof which are manufactured or distributed by the warrantor.

Dealer replacements are made subject to in-warranty validation by warrantor.

PROOF-OF-PURCHASE AND PROOF-OF-INSTALLATION DATES ARE REQUIRED TO SUPPORT WARRANTY FOR CLAIM FROM ORIGINAL OWNER. THIS FORM DOES NOT CONSTITUTE PROOF-OF-PURCHASE OR PROOF-OF-INSTALLATION.

DISCLAIMERS

NO EXPRESS WARRANTY HAS BEEN OR WILL BE MADE IN BEHALF OF THE WARRANTOR WITH RESPECT TO THE MERCHANTABILITY OF THE HEATER OR THE INSTALLATION, OPERATION, REPAIR OR REPLACEMENT OF THE HEATER OR PARTS. THE WARRANTOR SHALL NOT BE RESPONSIBLE FOR WATER DAMAGE, LOSS OF USE OF THE UNIT, INCONVENIENCE, LOSS OR DAMAGE TO PERSONAL PROPERTY, OR OTHER CONSEQUENTIAL DAMAGE. THE WARRANTOR SHALL NOT BE LIABLE BY VIRTUE OF THIS WARRANTY OR OTHERWISE FOR DAMAGE TO ANY PERSONS OR PROPERTY, WHETHER DIRECT OR INDIRECT, AND WHETHER ARISING IN CONTRACT OR IN TORT.

Some states do not allow the limitation or exclusion of incidental or consequential damages, so the above limitation or exclusion may not apply to you.

This warranty gives you specific legal rights, and you may also have other rights which vary from state to state. Should governmental regulations or industry standards prohibit the Manufacturer from furnishing a comparable model replacement under this warranty, the Owner will be furnished with the closest comparable water heater meeting the current governmental regulations and industry standards. A supplementary fee may be assessed to cover the additional cost associated with the changes made to meet applicable regulations and standards.

Fill out and keep with water heater.

IMPORTANT INFORMATION

Model Number _____
Serial Number _____
<u>Installation Information:</u>
Date Installed _____
Company's Name _____
Street or P.O. Box _____
City, State, and Zip Code _____
Phone Number _____ Plumber's Name _____

