

<http://waterheatertimer.org/power-vent-water-heater-troubleshoot.html>

Residential and Light Commercial Power Vented Water Heaters



MODELS COVERED

Residential Models

FPST, FPSH 40/50, FPCR, FPD,

FPSE 75, FPSH 75

Series 250 through 261

Commercial Models

BTF 75, BTI 80, BTI 100

Series 100 through 105

**Residential, And Light Commercial, Power Vented
Gas Products Service Handbook**

TABLE OF CONTENTS

| | PAGE | | PAGE |
|---|--------|--|---------|
| Handbook Introduction | 1 | FPSE 75 FPSH 75 BTF 75 | |
| | | Description..... | 19 |
| Installation Notes | 2 | Blower Information 250, 251 Series..... | 19 |
| | | Blower Information 260, 261 Series..... | 20 |
| Preservice Checklist | 2 | Burner Information..... | 21 |
| | | FPSE and BTF 75 Wiring Diagram | 22 |
| Venting Information | 3 - 4 | BTI 80 and 100 | |
| | | Description..... | 23 |
| Vent Termination Clearances | 5 | Blower Information..... | 23 |
| | | Burner Information..... | 24 |
| Product Introduction | 6 | Wiring Diagram..... | 25 |
| Honeywell SmartValve | | Sequence of Operation | 26 - 27 |
| SmartValve™ Information..... | 7 | | |
| Ignition Module Portion..... | 7 | SmartValve Troubleshooting | |
| Temperature and High Limit Portion..... | 8 | SmartValve Troubleshooting..... | 28 |
| Gas Valve Portion..... | 9 | Troubleshooting Notes | 29 - 30 |
| FPST Models 250 - 251 Series | | Troubleshooting Guide..... | 31 |
| Description..... | 10 | Power Supply Tests..... | 32 - 36 |
| Blower Information..... | 10 | Blocked Exhaust, Blocked Inlet Switch Test.... | 37 |
| Burner Information..... | 11 | Vent Temperature Limit Switch Test | 38 |
| FPSH, FPCR Models 250 - 261 Series | | Air Proving Circuit Test..... | 39 - 41 |
| Description..... | 12 | Igniter Resistance Test..... | 42 |
| Blower Information 250-253 Series..... | 12 | Igniter Power Test | 43 |
| Blower Information 260-261 Series..... | 13 | Igniter Assembly Check..... | 44 |
| Burner Information..... | 14 -15 | Gas Pressure Test..... | 45 |
| FPD Models 250 - 251 Series | | General Service Information | 57 - 58 |
| Description..... | 16 | | |
| Blower Information..... | 16 -17 | | |
| Burner Information..... | 17 | | |
| Wiring Diagram..... | 18 | | |

HANDBOOK INTRODUCTION

The service handbook is designed to aid in servicing and troubleshooting A.O. Smith residential and light commercial power vented water heaters in the field. No duplication or reproduction of this book may be made without the express written authorization of the A.O. Smith Water Products Company.

The following text and illustrations will provide you with a step by step procedure to verify proper installation, operation, and troubleshooting procedures. Additional quick reference data is included to assist you in servicing these products.

The information contained in this handbook is designed to answer commonly faced situations encountered in the operation of this product line and is not meant to be all inclusive. If you are experiencing a problem not covered in this handbook, please contact A.O. Smith Technical Information at 1-800-527-1953, by email at help@hotwater.com, or your local A.O. Smith Water Products company representative for further assistance. Our website at: <http://www.hotwater.com> is also a resource for installation and service information. This handbook is intended for use by licensed plumbing professionals and reference should be made to the installation manual accompanying the product. This handbook contains supplemental information to the product's installation and operation manual.

INSTALLATION NOTES

Always Read Heater Installation Manual for Details

BTI models use room air for combustion and vent vertically.

Models FPST, FPSH, FPCR, FPSE, and BTF use room air for combustion and may exhaust vent through the side wall or roof.

Model FPD uses outside air, drawn directly to the heater through piping, for combustion air and may vent through the sidewall or roof

| | |
|-------------------|---|
| Flammables | Always keep flammable items and vapors away from a water heater. On direct vent models, be certain that no flammable vapors could be drawn into the air intake from outdoors. |
|-------------------|---|

PRE-SERVICE CHECKLIST

- Reference the water heater installation and operation manual that applies to your water heater.
- Also reference the water heater model and rating plate on the upper, front of the water heater (White paper, black print, star in a circle logo in lower, right corner)
- Before doing anything, take note of present status.
 - 1) Blower on or off
 - 2) Igniter glowing or off
 - 3) "SmartValve" models have a white L.E.D. next to the temperature knob. Is this off, on, dim, flashing? If flashing, how many times (2-6) between 2 second delays?
 - 4) Does hot water temperature (at a nearby faucet) indicate the water heater should be satisfied or heating?
 - 5) Note status of doors, windows, fans, etc. that may affect room conditions.
 - 6) Could outdoor winds be affecting exhaust and/or intake vent conditions?

It may be advisable to conduct electrical tests– working up the "sequence of operation" ladder– before resetting the electrical system

- 7) Installation: Per installation manual instructions
- 8) Tank full of water
- 9) Proper gas-natural or propane
- 10) Proper gas supply pressure
- 11) Installed, new, temperature and pressure relief valve
- 12) Installed expansion tank-necessary
- 13) Exhaust piping installed per instruction manual. Condensate free to drain
- 14) Air intake vent (Direct vent installations only) properly installed
- 15) Exterior clearances per code
- 16) No flammable or corrosive vapors near the heater or air intake
- 17) Supply voltage-Proper polarity (Neutral to ground check \pm '0' VAC: "Hot" to ground=115-125 VAC)
- 18) Water heater electrical system is grounded

VENTING INFORMATION

Models FPSH, FPCR, FPST, FPSE, FPD 250 – 261 Series BTF 75 Series 100 - 101

Improper venting of these heaters will lead to unnecessary service complaints. Along with reversed polarity and an improper earth ground in the power supply it has become the most frequent cause of heater malfunction with this line of water heaters.

FPD models are “Direct Vent” heaters. This means they will have a two pipes terminating either vertically or horizontally outside. The second pipe brings in fresh air for combustion. All other “power vented” heaters in the class use room air for combustion.

The venting chart on the following page will outline **by model and “series” number** the venting limits allowed for each of these heaters. Be sure to note the series number of the heater and only use the corresponding venting limit information for that series heater. Except for the FPD direct vent model, which can only vent in 3” pipe, these heaters can all be vented in two sizes of PVC pipe, the larger size will extend the venting limitation considerably.

When a given installation would require exceeding the maximum vent length or number of fittings being used to vent the heater to its termination point in the smaller of the two vent sizes, it is required to use the larger size.

Keep in mind 2”- 90° elbows count for 8 linear feet of vent pipe, 3” and 4”- 90° elbows count for 5 linear feet.

Venting Installation Precaution

The Blocked Exhaust and Inlet Air Proving Switches have been engineered to shut the water heater down when the vent system lengths and limitations have been exceeded, there is no room to “fudge” when installing the vent system on these power vented water heaters.

Exceeding these venting limitations will cause operational problems and lead to needless customer dissatisfaction.

Models BTI 80 & BTI 100 Series 104, 105

These model heaters, also covered in this manual, are Category I appliances (negative pressure in the exhaust vent). These heaters vent vertically in standard B vent material. Follow the National Fuel Gas Code installation guidelines for “**fan assisted**” Category I Venting.

VENTING INFORMATION

A O Smith Power Vent Water Heater Venting Guide

| Model | Series | Max Equiv Feet 2" Pipe | Max Equiv Feet 3" Pipe | Max Equiv Feet 4" Pipe | 90° Elbow = Feet | Max Number Of Elbows |
|-------------------|-----------|------------------------|------------------------|------------------------|------------------|---------------------------|
| FPSH, FPCR 40, 50 | 250 - 253 | <u>54</u> | 80 | | $\frac{8}{5}$ | $\frac{2'' - 4}{3'' - 6}$ |
| FPSH, FPCR 40, 50 | 260 - 263 | <u>46</u> | 80 | | $\frac{8}{5}$ | $\frac{2'' - 4}{3'' - 6}$ |
| FPST 50 | 250 - 253 | <u>35</u> | 70 | | $\frac{8}{5}$ | $\frac{2'' - 4}{3'' - 6}$ |
| FPSE 75 | 250, 251 | | <u>30</u> | 60 | $\frac{5}{5}$ | $\frac{3'' - 4}{4'' - 5}$ |
| BTF 75 | 100 - 103 | | <u>30</u> | 60 | $\frac{5}{5}$ | $\frac{3'' - 4}{4'' - 5}$ |
| FPSH 75 | 260 - 263 | | <u>30</u> | 85 | $\frac{5}{5}$ | $\frac{3'' - 4}{4'' - 5}$ |
| BTF 75 | 104, 105 | | <u>30</u> | 85 | $\frac{5}{5}$ | $\frac{3'' - 4}{4'' - 5}$ |
| FPD 40, 50 | 250 - 253 | | 40 | | 5 | 3" - 3 |

This chart has been prepared to show the venting length and fitting limitations for these products. The first thing that must be done before actually measuring the equivalent vent length is to first check the model number of the heater and just as important, the “**series**” number. Not the serial number, which has 11 characters, but the three digit “**series**” number specifies which components were used in manufacturing and this determines the actual limitations on venting. The series number is found on the same sticker as the model and serial number directly following each. Example: < FPSH 50 250 – MD01XXXXXXXX 250 > FPSH 50 is the model number, “**250**” is the **series** number, and the 11 character number MD01XXXXXXXX is the serial number.

Be sure to notice the “equivalent” feet of pipe that each 90° elbow counts for when planning the vent system. **3” and 4” - 90° elbows count for 5 linear feet of pipe, 2” - 90° elbows will count for 8 linear feet of pipe.** A 45° elbow will count for half of what the 90° elbow does in the given pipe size.

Any vent fittings supplied with the heater by the manufacturer (such as the terminations) do not figure into the equivalent feet of pipe, all field supplied vent fittings do figure into the equivalent feet calculations. Elbows placed in close proximity to one another can also lead to service complaints. Avoid installing elbows extremely close to each other in a vent system. Last, ***the maximum number of elbows shown in this chart cannot be exceeded even if the total equivalent feet limit has not yet been reached.***

VENT TERMINATION CLEARANCES

THROUGH-THE-WALL (single exhaust pipe) INSTALLATIONS

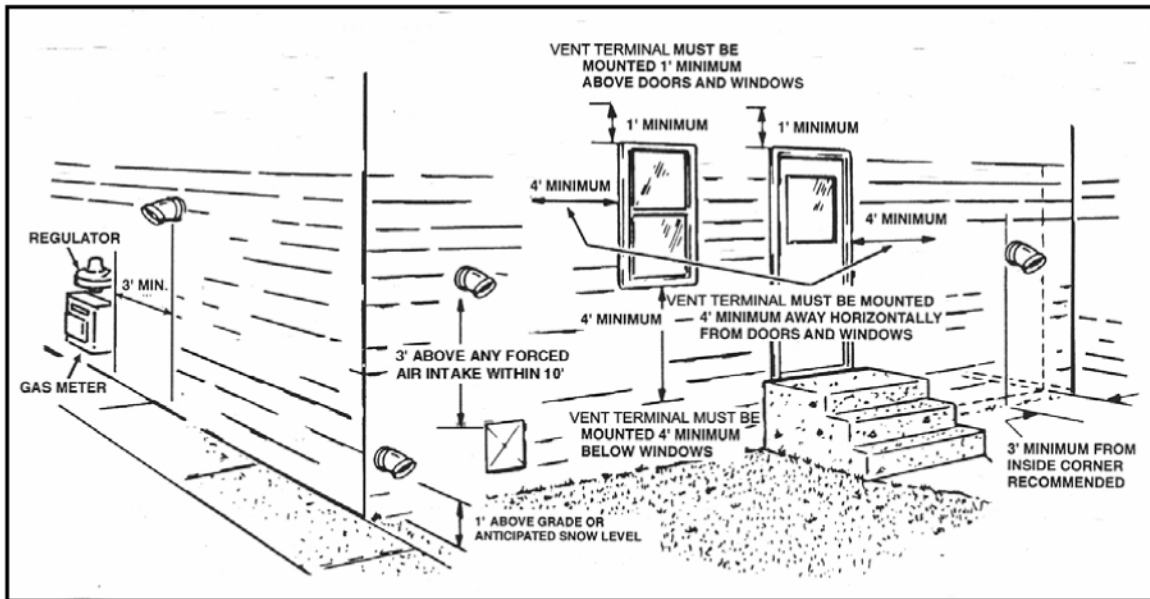

Note: Some models have a "Tee" vent terminal. Also note that "Through-The-Wall" (single pipe) terminals must be further from windows and doors than "Direct Vent" (two pipe) terminals.

DIRECT VENT (two pipe, exhaust and intake) INSTALLATIONS

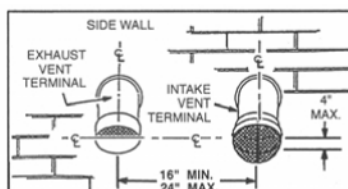
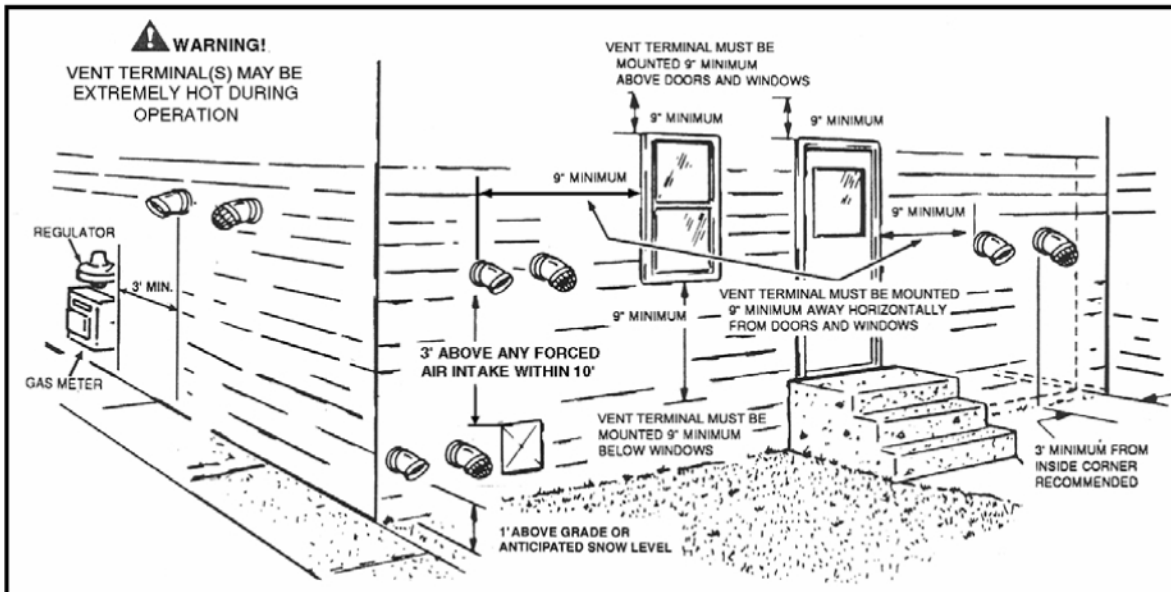

PRODUCT INFORMATION

This portion of this manual refers to models FPST, FPSH, FPCR, FPSE-75, FPD, BTF-75 and BTI Water Heaters which use the Honeywell SmartValve™ control.

Series 250, 252, 260 use Natural Gas and series 251, 253, 261 use Propane Gas. Series 100, 104 use Natural Gas and Series 101, 105 use Propane Gas.

Preview installation and venting information contained on pages 2 - 6 of this manual.
Preview information contained in the installation manual for your particular water heater.

- FPST** Sidewall, power vented product offering the highest recovery of our, current, 50 gallon, residential water heaters of this type.
- FPSH** Sidewall, power vented product; use 2 or 3 inch vent piping. May be ordered with NOx compliant features.
- FPCR** Similar to the FPSH with thicker insulation and NOx compliance – primarily to meet California codes.
- FPSE-75** Sidewall, 3 or 4” vent piping, power vented
- FPSH-75** Sidewall, 3 or 4” vent piping, power vented, Train Blower (260 & 261 series)
- FPD** Sidewall, power direct vent product
- BTF-75** Light commercial, similar to FPSE-75
- BTI** Light commercial “Induced” draft blower, category I, vertical venting.

Note: All of these models are also approved for roof venting.

Servicing of all of these models will follow the same procedures.

HONEYWELL SMARTVALVE™ INFORMATION

SmartValve™ Product Information:

The SmartValve™ combines gas valve, thermostat, and ignition module functions into one control. It requires 115-125 VAC with correct polarity and a proper earth ground. AOS SmartValve™ equipped heaters will draw approximately 7.5 amps with the blower and igniter energized. **SmartValve™ equipped heaters should be on their own dedicated circuit breaker. GFI (Ground Fault Interruption) circuit breakers can cause erratic operation, for this reason use non GFI circuit breakers.**

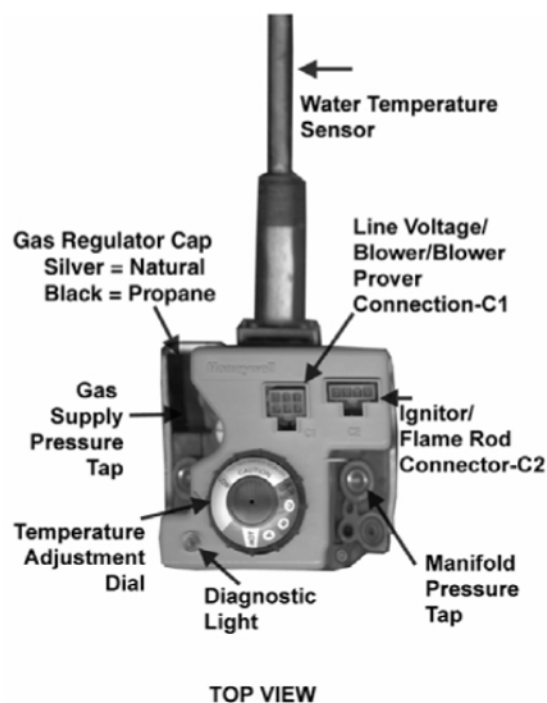
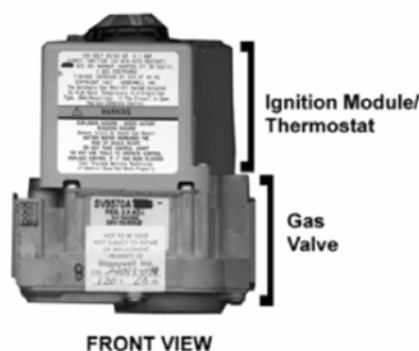

| SmartValve™ Control | | | | |
|-----------------------|---------|--|-------|---------|
| Heater | Fuel | | Shank | Threads |
| FPSH/FPD 40/50 | Natural | | 1.40" | Right |
| | Propane | | 1.40" | Left |
| FPST-50 FPCR-40/50 | Natural | | 2.50" | Right |
| | Propane | | 2.50" | Left |
| FPSE-75 FPSH-75 | Natural | | 2.06" | Right |
| | Propane | | 2.06" | Left |
| BTF-75 BTI-80/100 | Natural | | 2.06" | Right |
| | Propane | | 2.06" | Left |

Ignition Module Portion:

| Activity | Time | Accumulated Time |
|---|-----------------------------------|--|
| Pre Purge | 5 Sec | 16 Seconds 1 st try 21 Seconds 2 nd - 4 th try |
| HSI Warm Up | 7 Sec 1 st try, 12 Sec | |
| Ignition Act. Period | 3 Sec | |
| Flame Recognition | 1 Sec | |
| Ignition Trial | 4 Sec | |
| Interpurge | 30 Sec | |
| Post Purge | 5 Sec | |
| Retries | 3 (after initial trial) | |
| Auto Reset from Lockout | 1 hour | |
| Has service L.E.D. to aid troubleshooting | | |

Approximate Temperature:

| Thermostat Setting | Residential Products | Commercial Products |
|---------------------------|-----------------------------|----------------------------|
| Setting | Temp, (\pm - 4°) | |
| Very Hot | 160° | 180° |
| “C” | 150° | 163° |
| “B” | 140° | 145° |
| “A” | 130° | 127° |
| Hot | 120° | 110° |
| Low | 80° | 80° |

Approximately a 12° drop in temperature reactivates thermostat. Recommended starting set point is 120°F. Settings below 120° may result in excessive condensation and a minimal amount of hot water available for use. If higher settings are desired, increase setting in small amounts.

Temperature Sensor Portion:

The sensor is a thermistor, which plugs into the base of the valve from the temperature probe.

Thermistors are very reliable. A change in water temperature changes the Ohms resistance of the thermistor. The thermostat interprets this and the thermostat reacts.

One or four flash sequence would indicate a malfunction with these sensors.

Red and Yellow = Thermistor Sensor
White and Black = E.C.O.

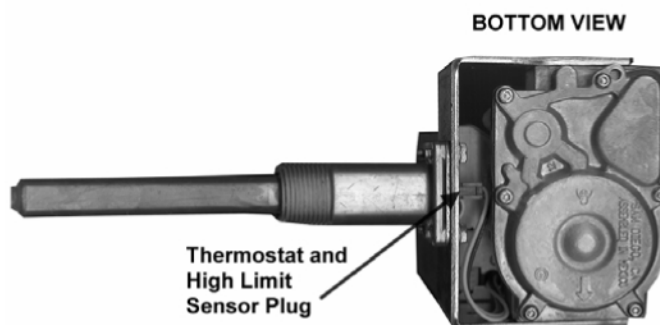
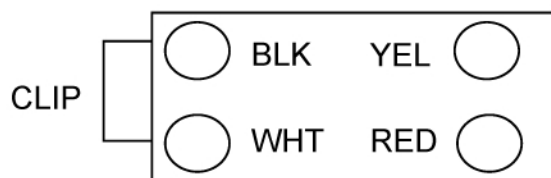

High Limit (E.C.O.) Portion:

- One Time Operation
- Opens at 188°F on Residential valves and 199°F on Commercial
- Replace entire valve if activated

Gas Valve Portion:

| | | | | |
|------------------------------|---------------------------------|-------------------------|--------|------------------|
| Electrical – 120VAC:50/60 Hz | | | | |
| Connections | | Gas Press – Inches W.C. | | |
| Inlet ½” NPT | Outlet * ½ Inverter Flare | Supply | | Manifold |
| | | Min. | Max. | Non – Adjustable |
| | | 4.5 N | 10.5 N | 3.5 N |
| | | 11.0 P | 13.0 P | 10.0 P |

Propane valves will be noted in the label text and have a red temperature knob and a black cover screw over the regulator..

Natural valves will be noted in the label text and have a black temperature knob and a silver cover screw over the regulator.

*Natural gas models have right hand threads for burner tube attachment. Propane Gas models have left hand threads.

See troubleshooting section for flashing LED error code information.

FPST MODELS WITH SMARTVALVE™ CONTROL Series 250, 251

Description:

FPST: Fuel Saver, Power Vent, Sidewall Venting, Top Performance

- Available in Natural or Propane Gas
- 50 gallon storage
- BTUH input – 65,000 on Natural Gas; 53,000 on Propane Gas

Blower Information:

FPST model, 250 and 251 series:

- Manufactured by “Fasco”.
- Fasco model 7062-4829
- 115 VAC, 60 Hz, 0.76 Amp, 3450 RPM
- Plastic housing
- 8 foot condensate hose from the bottom of the housing
- No oiling required
- Vent temperature limit switch - normally closed (N.C.)
 - Opens at $165^{\circ}\text{F} \pm 5^{\circ}\text{F}$
 - Closes at $135^{\circ}\text{F} \pm 8^{\circ}\text{F}$ (automatic reset)
- Blocked exhaust switch - normally open (N.O.) Switch must open again before next call for heat begins
 - Closes at $-.04''$ W.C. negative pressure

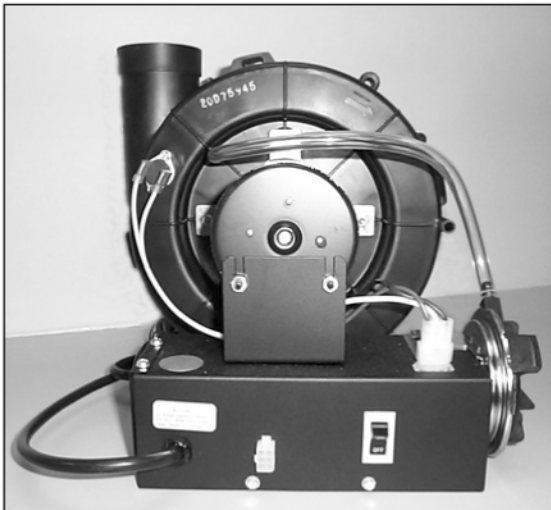

FPST - Continued

Burner Information:

FPST model, 250 and 251 series:

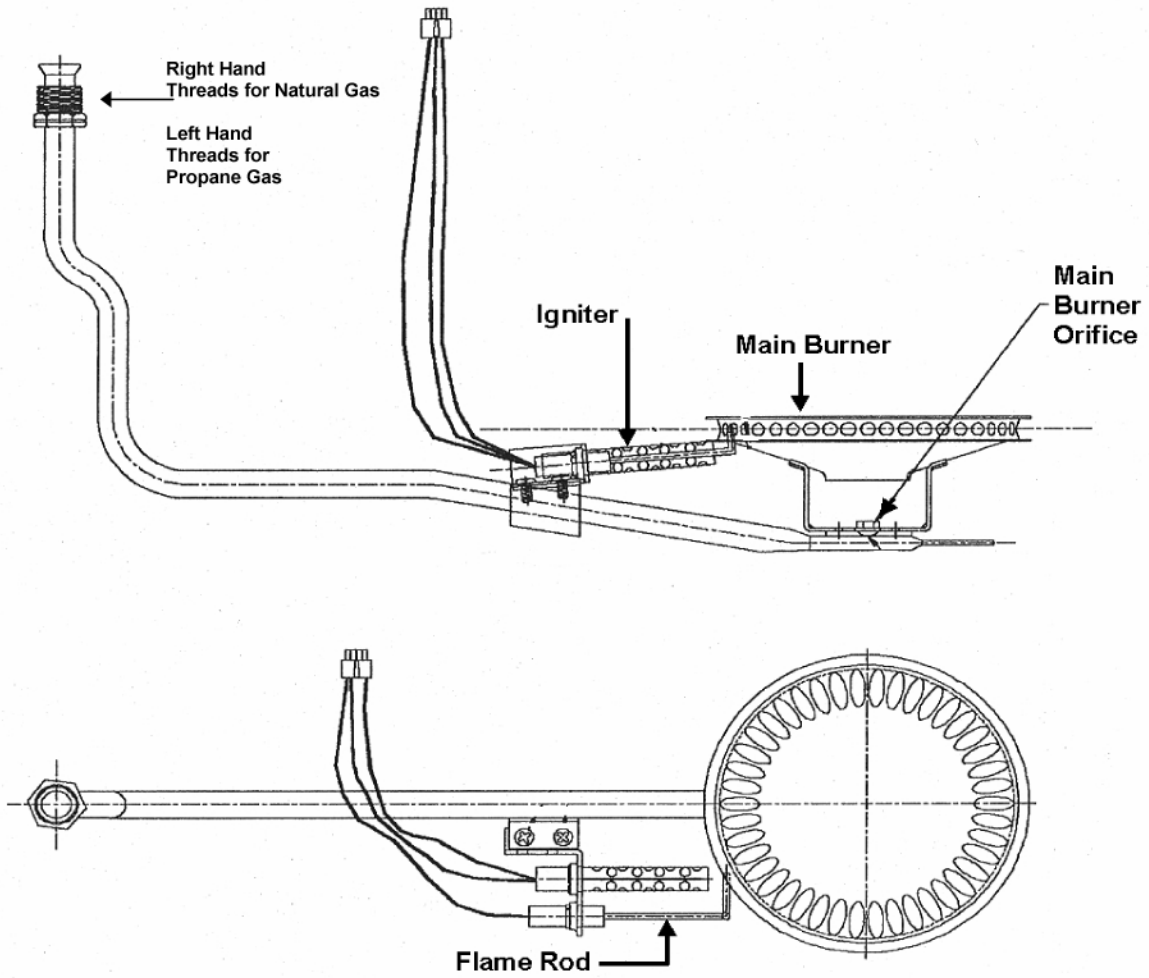

| FPST - BURNER ASSEMBLY | |
|------------------------|-----------|
| *Main Orifice | |
| Nat. | Prop. |
| #24 Drill | #44 Drill |

*Nat. = Brass color: Prop. = Red Color

FPSH AND FPCR MODELS WITH SMARTVALVE™ CONTROL Series 250 - 261

Description:

FPSH – Fuel Saver, Power Vent, Sidewall, High Performance and
FPCR – Fuel Saver, Power Vent, California Requirements

- Available in Natural or Propane Gas
- 40 or 50 gallon storage
- BTUH input: 46,000 on Natural Gas; 40, 000 on Propane Gas
- 2 inch or 3 inch vent piping

Blower Information:

FPSH/FPCR models, 250 - 253 series:

- Manufactured by Fasco
- Fasco model 7021-10195
- 115 VAC, 60Hz, 1.8 Amp, 3400 RPM
- Plastic housing
- 8 foot condensate hose from bottom of housing
- No oiling required
- Vent temperature limit switch - normally closed (N.C.)
 - Opens at $145^{\circ}\text{F} \pm 5^{\circ}\text{F}$
 - Closes at $115^{\circ}\text{F} \pm 8^{\circ}\text{F}$ (automatic reset)
- Blocked exhaust switch – normally open (N.O.) Switch must open again before next call for heat begins
 - Closes at $-.04''$ W.C. negative pressure

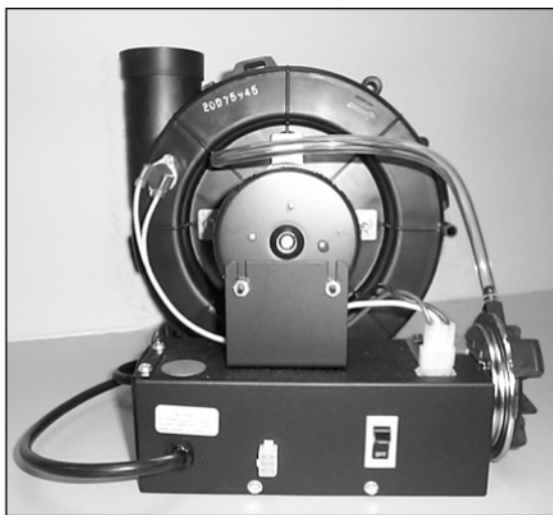

FPSH/FPCR - Continued

Blower Information - Continued:

FPSH/FPCR models, 260 - 261 series:

- “Train Blower” manufactured by Fasco
- Fasco model 7021-10770
- 115 VAC, 60Hz, 2.3 Amp, 3275 RPM
- Plastic housing
- 8 foot condensate hose from condensate coupling
- No oiling required
- Vent temperature limit switch - normally closed (N.C.)
 - Opens at $175^{\circ}\text{F} \pm 5^{\circ}\text{F}$
 - Closes at $135^{\circ}\text{F} \pm 8^{\circ}\text{F}$ (automatic reset)
- Blocked exhaust switch – normally open (N.O.) switch must open again before next call for heat begins
 - Closes at $-.61''$ W.C. negative pressure



FPSH/FPCR - Continued

Burner Information:

| FPSH Burner Assembly | | | | High Altitude Burner | | | |
|----------------------|--|-------|--------------------|----------------------|--|-------|--------------------|
| Heater Gallons | | Gas | *Orifice Drill No. | Heater Gallons | | Gas | *Orifice Drill No. |
| 40 | | Nat | 30 | 40 | | Nat. | 31 |
| 50 | | Nat | 30 | 50 | | Nat. | 31 |
| 40 | | Prop. | 48 | 40 | | Prop. | 50 |
| 50 | | Prop. | 48 | 50 | | Prop. | 50 |

* Natural Gas = Brass color; Propane = Red color

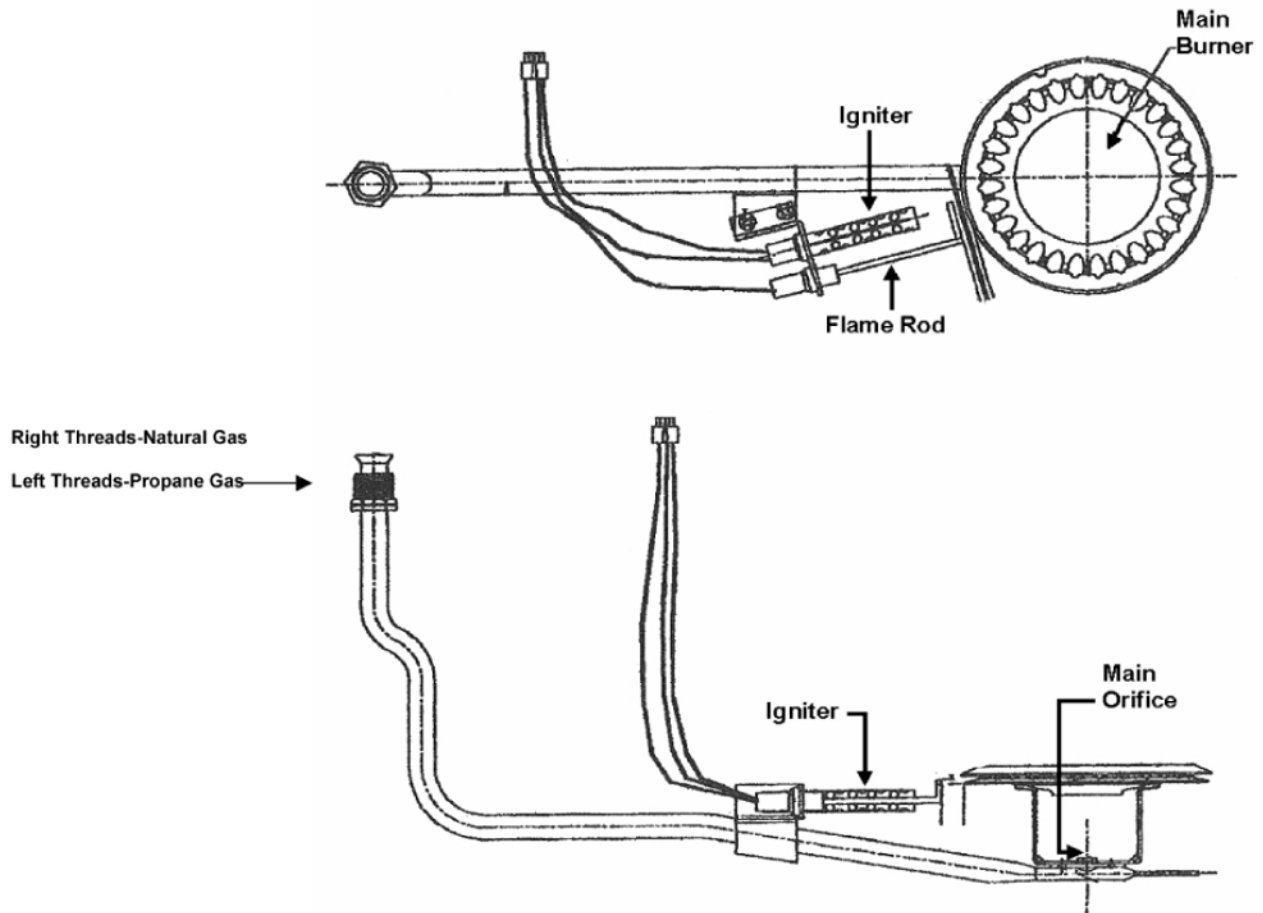

Note:

Models FPCR 40 and 50 were not in production at the time of this printing. However, there is a special order FPSH model heater (Natural gas only) that is equipped with a low NOx burner to meet the Nitrous Oxide (NOx) emissions standards for areas of California. The burner these special order FPSH model heaters are equipped with is shown on the following page.

FPSH/FPCR – Continued

Burner Information - Continued:

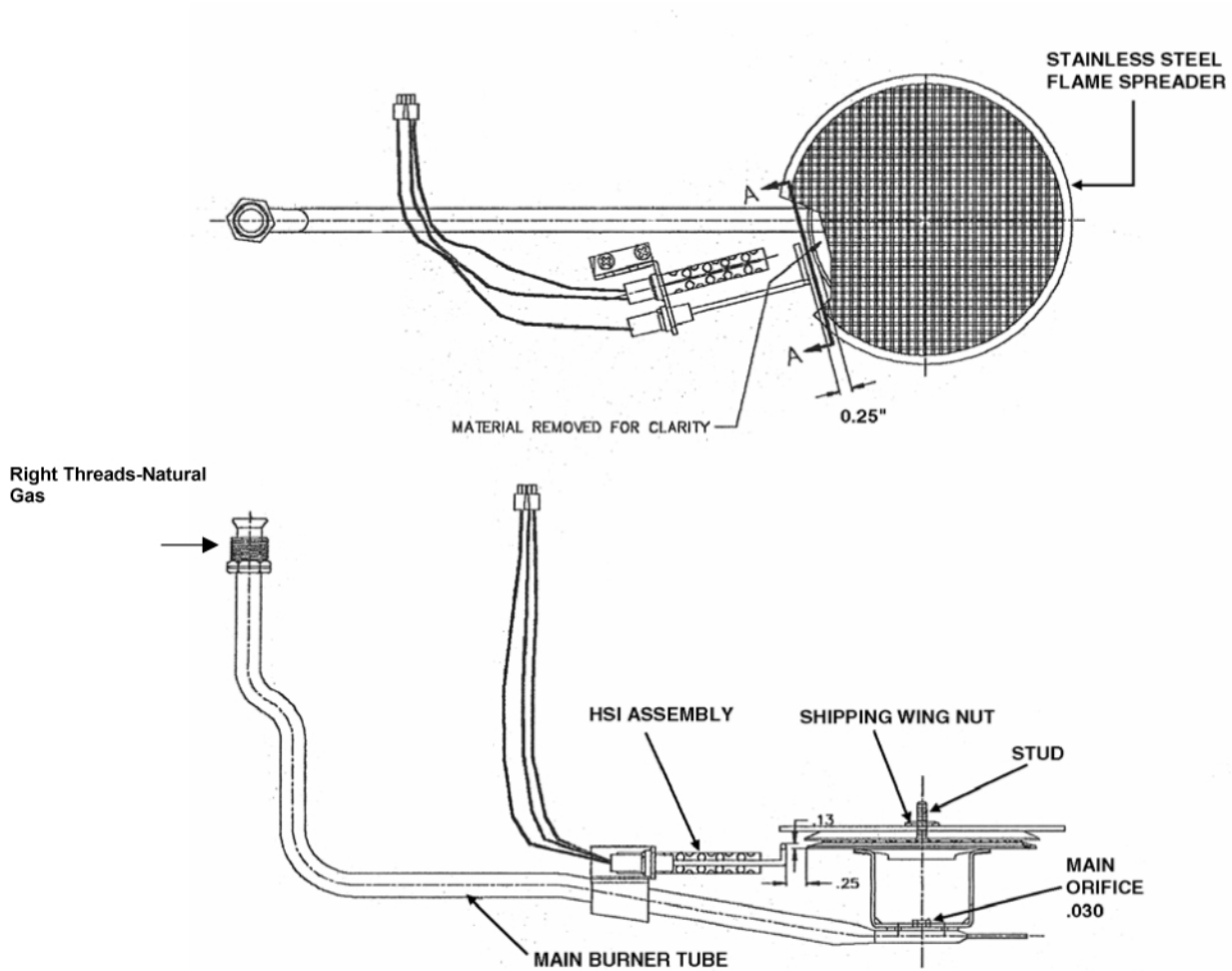

Special Order FPSH model Low NOx burner

FPD MODELS WITH SMARTVALVE™ CONTROL Series 250 and 251

Description:

FPD – Fuel Saver, Power vent, Direct Vented

- Vented sidewall or vertical
- Available in Natural or Propane Gas
- 40 or 50 gallon capacity
- BTUH input: 42,000 on Natural Gas; 40,000 on Propane

Blower Information:

FPD models, 250,251 series

- Manufactured by Jakel
- 115 VAC, 60Hz, 1.2 Amp, 3200 RPM
- No oiling required
- Blocked exhaust switch - normally open (N.O.) switch must open again before next call for heat begins
 - Closes at $-.10''$ W.C. negative pressure
- Blocked inlet switch - normally closed (N.C.)
 - Opens at $-.70''$ W.C. negative pressure

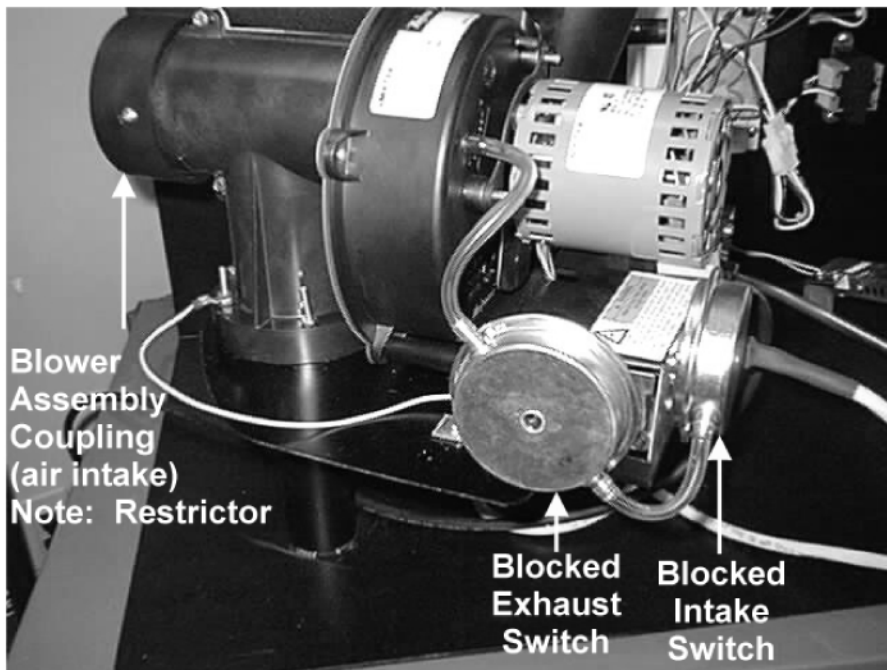

FPD - Continued

Blower Information - Continued:

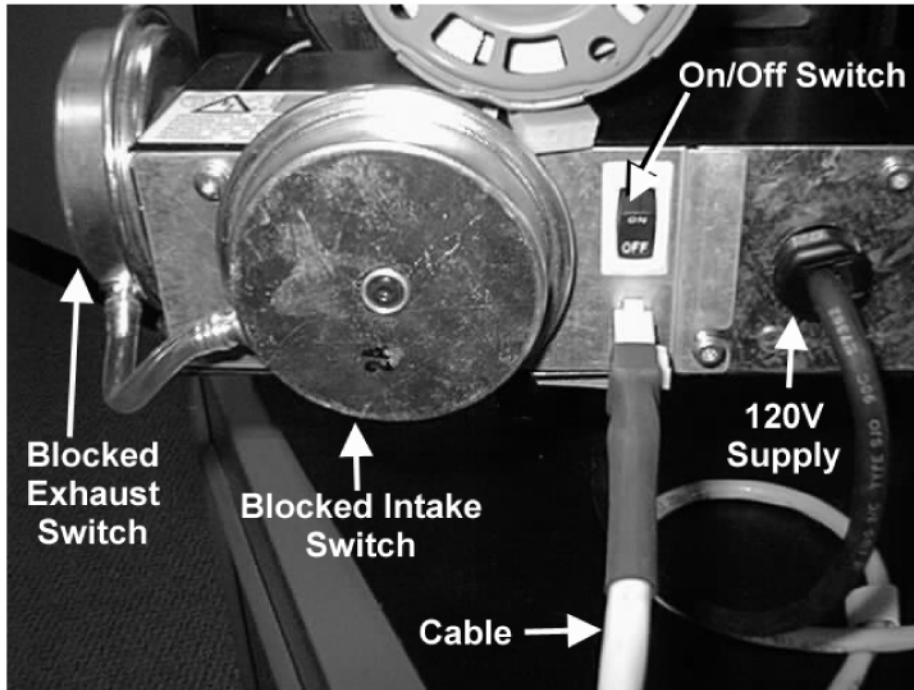

Burner Information:

| FPD Burner Table | | | |
|------------------|--|------|---------------|
| Heater Gallons | | Gas | *Orifice Size |
| 40 | | Nat. | .123 in. |
| 40 | | Pro. | #49 drill |
| 50 | | Nat. | .123 in. |
| 50 | | Pro. | #49 drill |

*Natural=Brass color; Propane=Red color

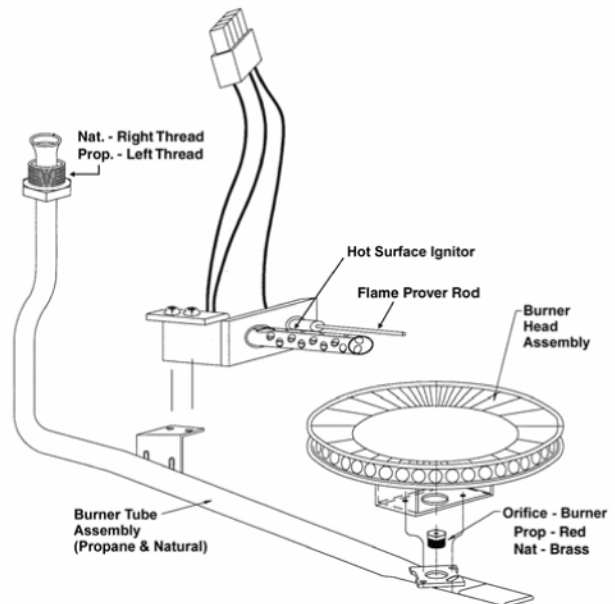

FPD, FPST, FPSH, FPCR MODELS 250, 251 SERIES WIRING DIAGRAM

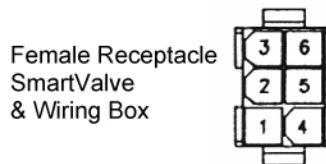
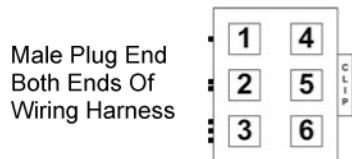
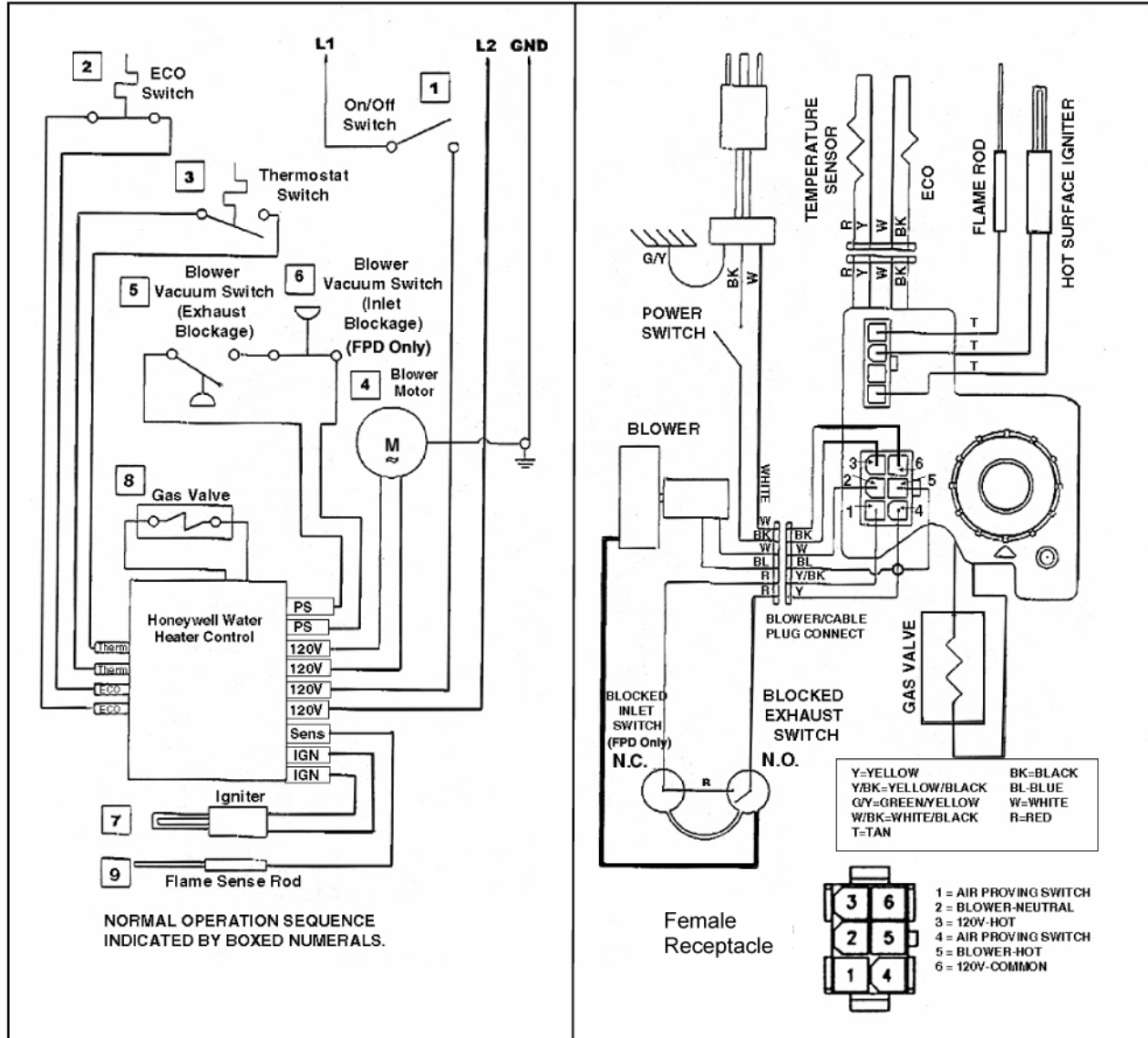

- 1=AIR PROVING SWITCH
- 2=BLOWER- HOT
- 3=120V - HOT
- 4=AIR PROVING SWITCH
- 5=BLOWER - NEUTRAL
- 6=120V-COMMON

**FPSE – 75 Series 250, 251 FPSH – 75 Series 260, 261
BTF-75 Series 100 - 105 WITH SMARTVALVE™ CONTROL**

Description:

Fuel Saver, Power Vent, Sidewall, Electronic Ignition

- 75 Gallon Storage
- 75,000 BTU Input Natural Gas and Propane
- 3" or 4" Vent Piping

BTF-75 Model Heaters Are For Use In Commercial Applications. The Hottest Setting On The SmartValve Is 180° F. The Built In High Limit Opens At 199.4° F.

**Vent Temp
Limit Switch
(Flue Gas)**

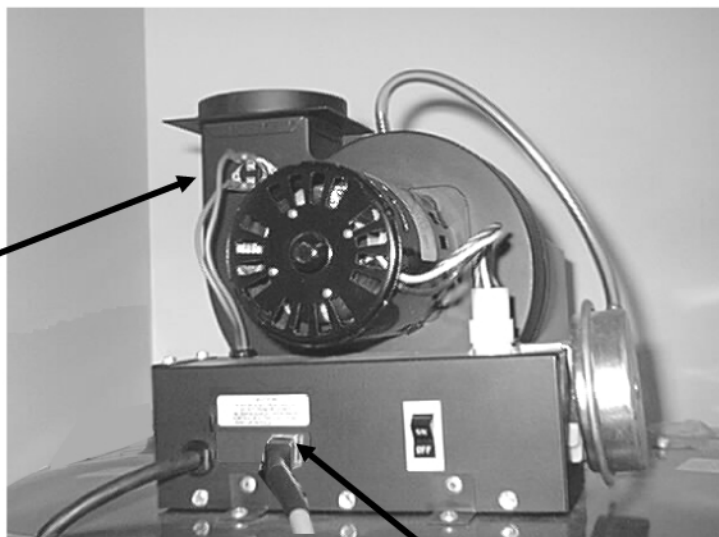

Wiring Cable Plug

Blower Information:

FPSE - 75 Series 250, 251 models

BTF - 75 Series 100, 101 models

- Manufactured by "Fasco"
- Fasco Model 702110906 Rev B
- 115 VAC, 60 Hz, 1.8 Amp, 3000 RPM
- Metal Housing – Do not allow condensation into blower
- Must be oiled
- Vent temperature limit switch – normally closed (N.C.)
 - Opens at 190°F ± 5°F
 - Closes at 150°F ± 8°F (automatic reset)
- Blocked exhaust switch - normally open (N.O.)
 - Closes at -1.27" W.C. negative pressure

FPSE 75 FPSH 75 BTF 75 - Continued

Blower Information - Continued:

FPSH – 75 Series 260, 261

BTF – 75 Series 104, 105

- “Train Blower” manufactured by Fasco
- Fasco Model 7021-11064
- 115VAC, 60 Hz 2.3 Amp, 3275 RPM
- Plastic housing
- 8 foot condensate hose from condensate coupling
- No oiling required
- Vent temperature limit switch – normally closed (N.C.)
 - Opens at $175^{\circ}\text{F} \pm 5^{\circ}\text{F}$
 - Closes at $135^{\circ}\text{F} \pm 8^{\circ}\text{F}$ (automatic reset)
- Blocked exhaust switch - normally open (N.O.)
 - Closes at -1.57" W.C. negative pressure

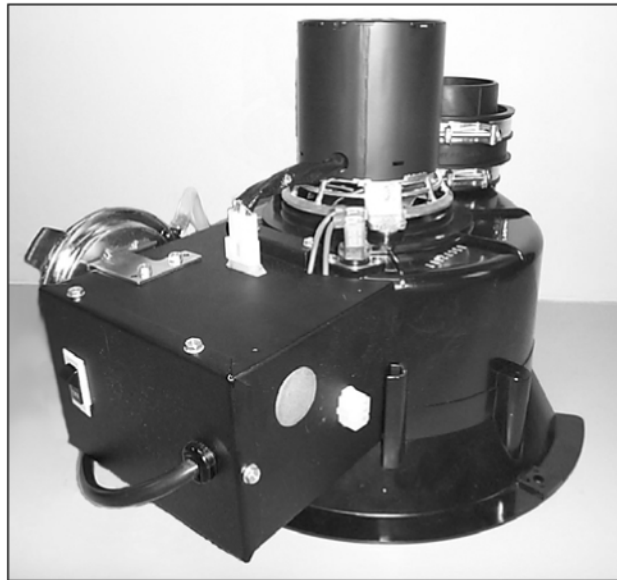

FPSE 75 FPSH 75 BTF 75 - Continued

Burner Information:

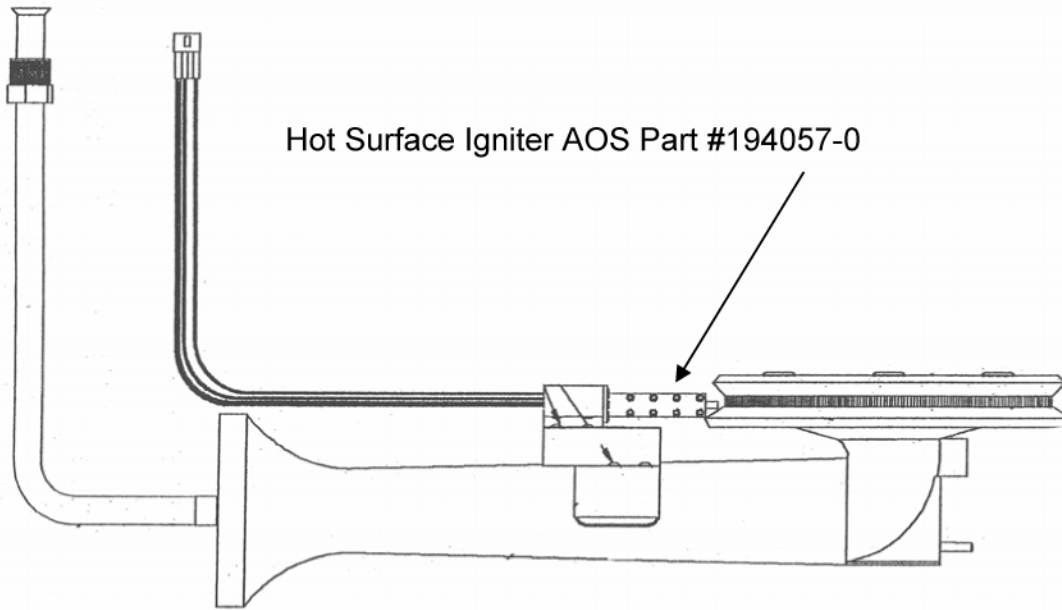

Main Burner

FPSE 75 - 250, 251 Series FPSH 75 - 260, 261 Series BTF 75 - 100, 101 Series

| Main Burner Orifice Table | | | |
|----------------------------------|---------|--|------------|
| Heater and Series | Gas | | Drill Size |
| FPSE 75 series 250 | Natural | | 21 |
| FPSE 75 series 251 | Propane | | 39 |
| | | | |
| FPSH 75 series 260 | Natural | | 20 |
| FPSH 75 series 261 | Propane | | 38 |
| | | | |
| BTF 75 series 100 | Natural | | 21 |
| BTF 75 series 101 | Propane | | 39 |
| | | | |
| BTF 75 series 104 | Natural | | 20 |
| BTF 75 series 105 | Propane | | 38 |

FPSE 75 AND BTF 75 100, 101 SERIES WIRING DIAGRAM

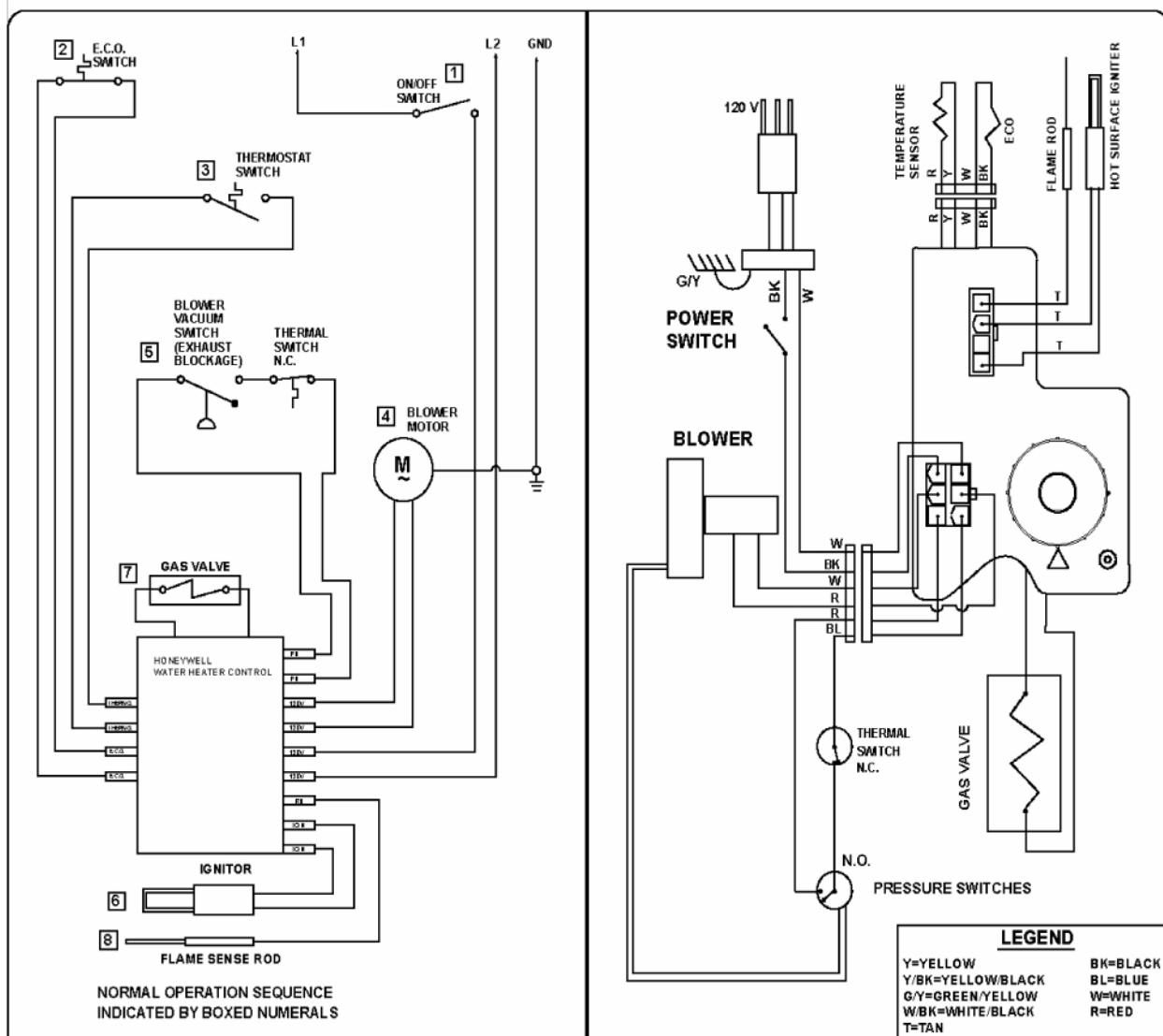

WARNING

DISCONNECT FROM ELECTRICAL SUPPLY BEFORE SERVICING UNIT.
REPLACE ALL DOORS AND PANELS BEFORE OPERATING HEATER.

IF ANY OF THE ORIGINAL WIRES SUPPLIED WITH THE APPLIANCE MUST BE REPLACED, IT MUST BE REPLACED WITH APPLIANCE WIRE MATERIAL WITH MINIMUM TEMPERATURE RATING OF 105°C AND A MINIMUM SIZE OF NO. 18 AWG.

194218-000

Male Plug End
Both Ends Of
Wiring Harness

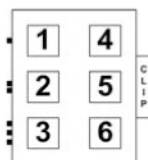

Female Receptacle
SmartValve
& Wiring Box



- 1=AIR PROVING SWITCH
- 2=BLOWER- HOT
- 3=120V – HOT
- 4=AIR PROVING SWITCH
- 5=BLOWER – NEUTRAL
- 6=120V-COMMON

BTI - 80 and 100 MODELS WITH SMARTVALVE™ CONTROL Series 104 and 105

Description:

BTI - Burkay, Tank Type, Induced Draft

- Commercial Water Heater – Max. 180° F water
- BTI-80: 74 Gallon storage, 80,000 BTU input, Natural or Propane Gas
- BTI-100: 98 Gallon storage, 100,000 BTU input – Natural Gas (Series 104)
80,000 BTU Input – Propane Gas (Series 105)

Blower Information:

- Manufactured by Fasco
- Fasco model 7021-10946
- 115 VAC, 60 Hz, 0.9 Amp, 3250 RPM
- Metal Housing
- No oiling required
- Blocked exhaust switch – normally open (N.O.) Switch must open again before next call for heat begins
 - Closes at $-.49''$ W.C. negative pressure

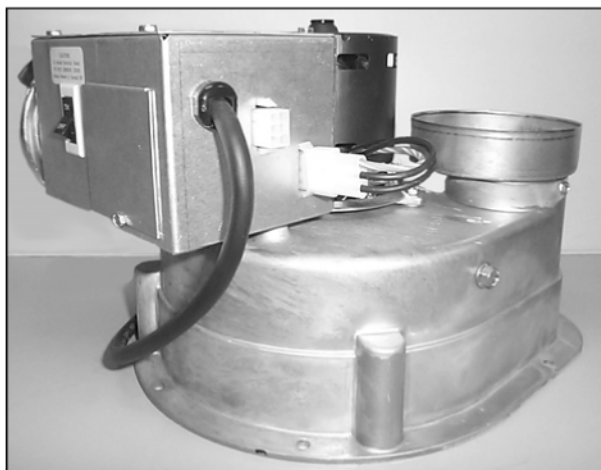

BTI - 80 and 100 MODELS - Continued

Burner Information:

Main Burner Tube/Orifice

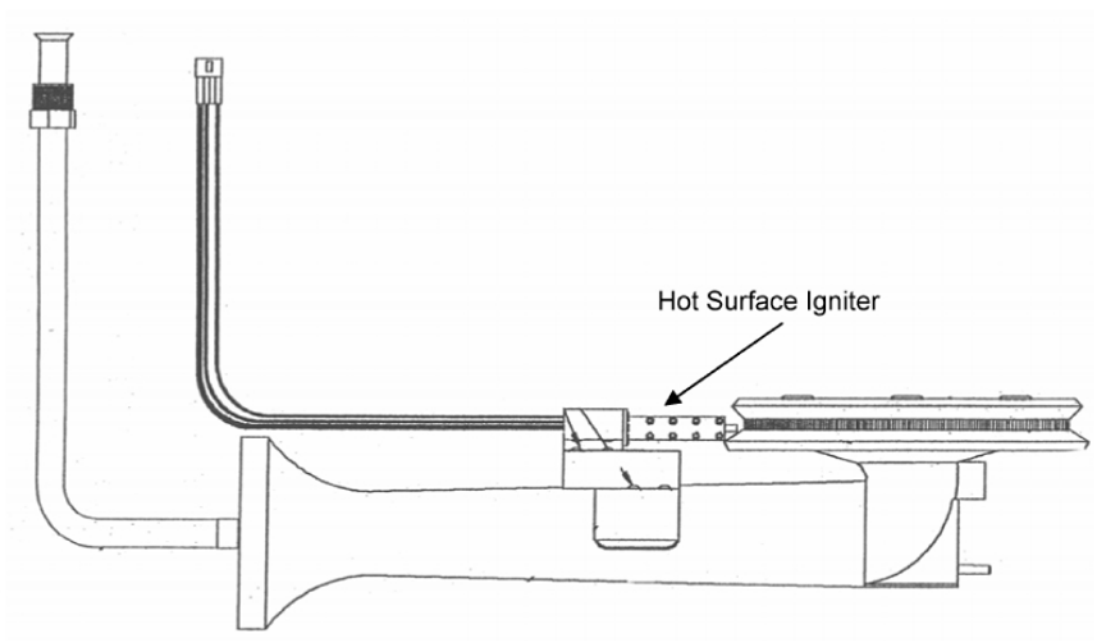

| Heater/Series | Gas Type | Orifice Drill Size |
|---------------|----------|--------------------|
| BTI-80/104 | Natural | 20 |
| BTI-80/105 | Propane | 38 |
| BTI-100/104 | Natural | 14 |
| BTI-100/105 | Propane | 38 |

BTI - 80 and 100 MODELS - Continued

WIRING DIAGRAM BTI SERIES 100,

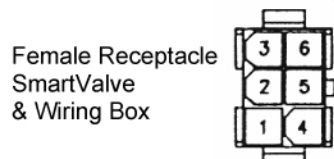
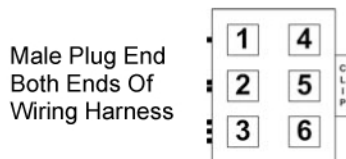
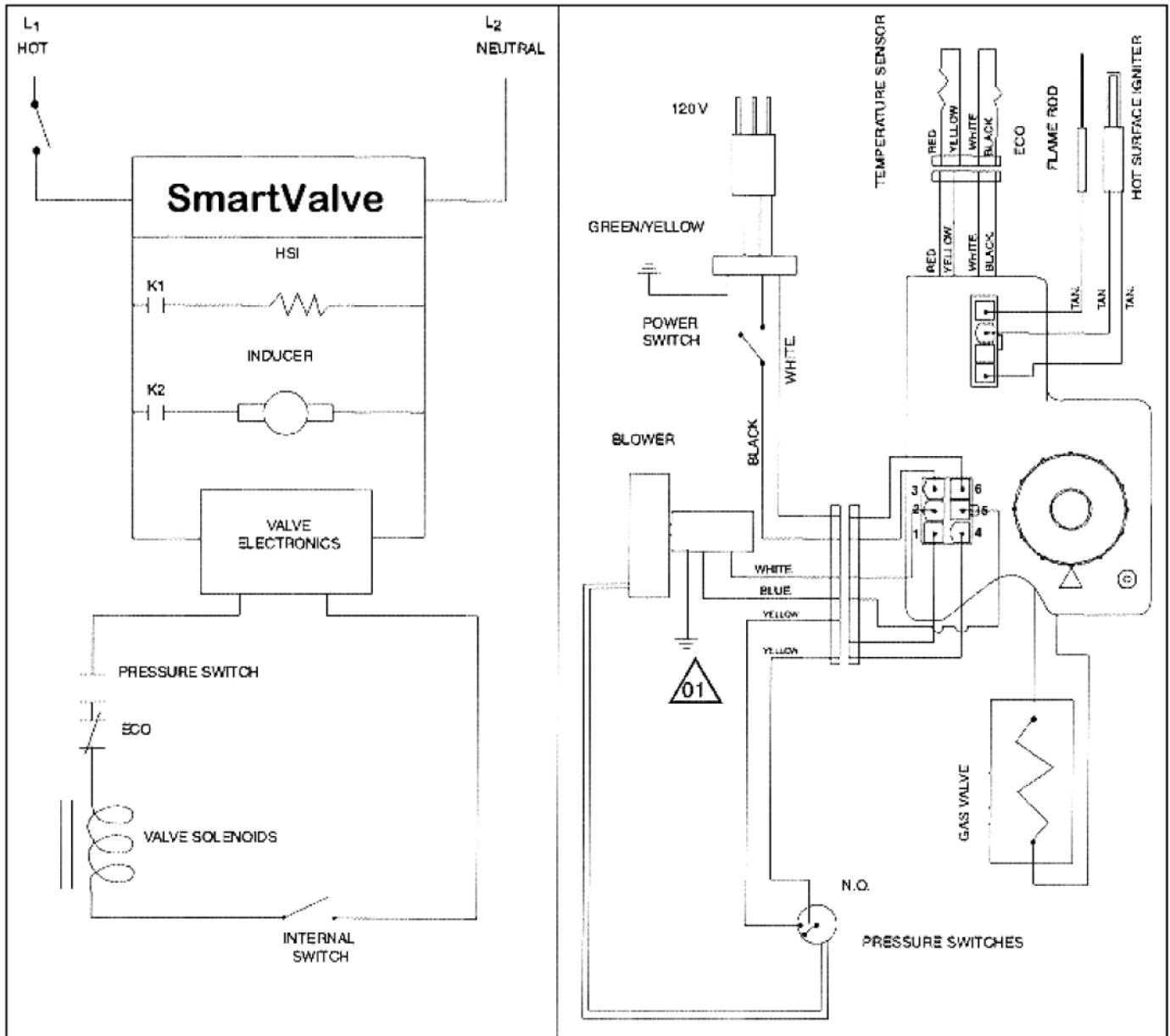

- 1=AIR PROVING SWITCH
- 2=BLOWER- HOT
- 3=120V - HOT
- 4=AIR PROVING SWITCH
- 5=BLOWER - NEUTRAL
- 6=120V-COMMON

SMARTVALVE™ SEQUENCE OF OPERATION

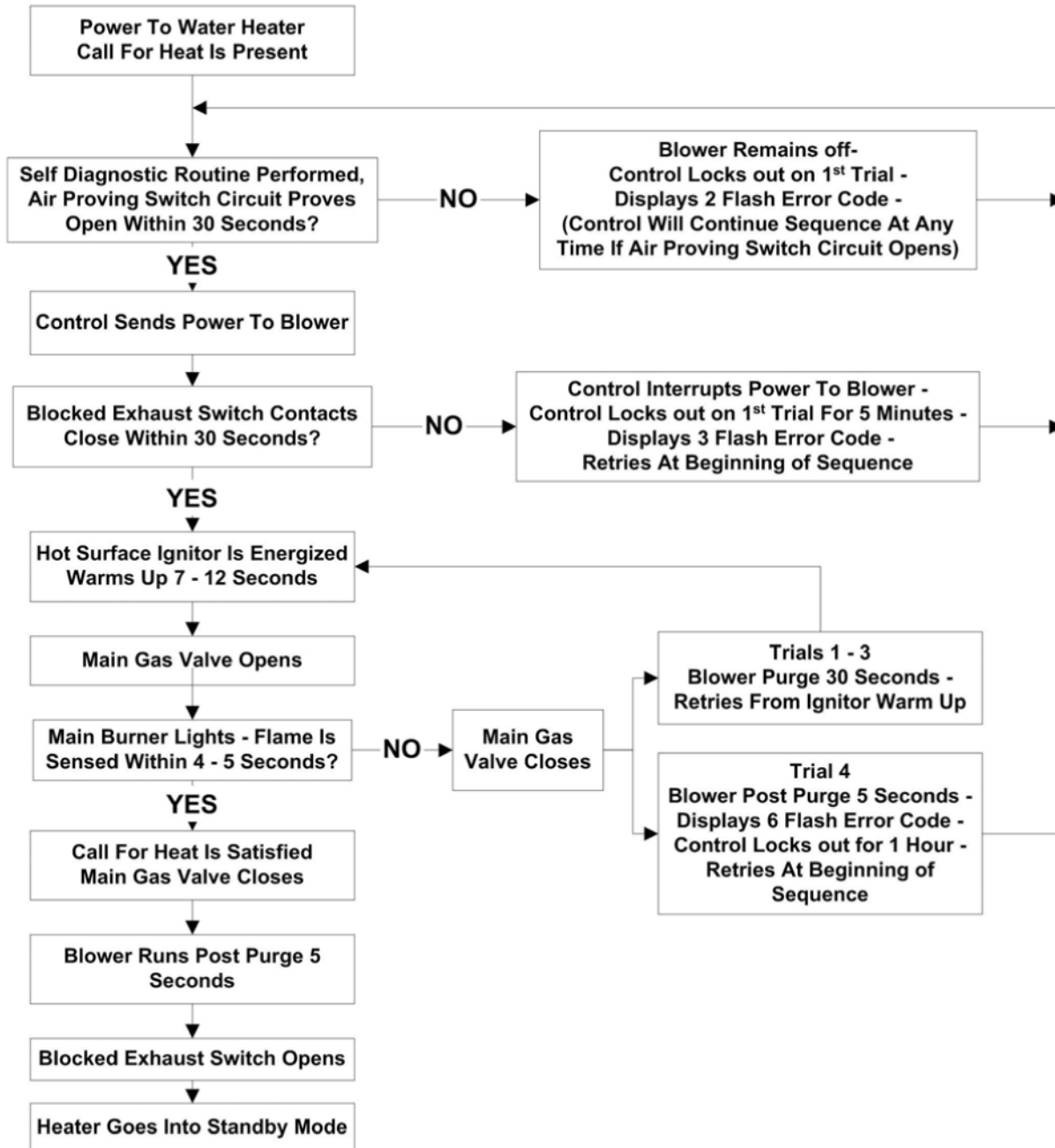

SMARTVALVE™ SEQUENCE OF OPERATION - Continued

1. 115 - 125 VAC is applied to the water heater.
2. Water temperature drops below set-point minus the differential.
3. A call for heat is activated.
4. The SmartValve control performs a self diagnostic routine. The air proving switch circuit must open within 30 seconds or the SmartValve will lockout and display a **2 flash** error code, the blower will not start. (Blocked exhaust switch contacts should have re-opened after previous cycle completed. If air proving switch circuit opens at anytime during lockout the SmartValve control will continue the sequence from this point.) *Air proving switch circuit will always have a blocked exhaust switch. FPD models will also have a blocked inlet switch. Some models will also be equipped with a vent temperature limit switch (see page 30 in this manual) in this circuit, other models will have the vent temperature switch wired into the 115 VAC neutral wire supplying the blower motor.*
5. SmartValve control sends 115 VAC to blower motor through wiring harness.
6. Blower starts and comes up to speed.
7. Negative pressure (slight vacuum) is induced in the blocked exhaust switch's plastic sensing tube.
8. Blocked exhaust switch (normally open) contacts close within 30 seconds. (The air proving switch circuit should now be closed) If the blocked exhaust switch contacts do not close within 30 seconds the SmartValve will de-energize the blower after an additional 30 second purge time. The SmartValve will then lockout for 5 minutes during which it displays a **3 flash** error code. After 5 minutes the SmartValve will retry at step four above. The SmartValve control can cycle this way indefinitely if the air proving switch circuit remains open.
9. SmartValve control sends 115 VAC to Hot Surface Igniter (HSI), igniter warms up 7 seconds on 1st trial for ignition, 12 seconds on 2nd - 4th trial.
10. SmartValve control opens main gas valve.
11. Main burner lights and proves flame within 4-5 seconds. If the flame is not sensed within 4-5 seconds the SmartValve will de-energize the gas valve, run the blower for a 30 second purge cycle, then try again at step nine for 3 additional tries. If after the 4th trial for ignition the flame is not proven, or if flame sense is lost a 4th time before the call for heat is satisfied, the SmartValve will run the blower for a 5 second post purge and then de-energize the blower. The SmartValve will lockout for 1 hour during which it displays a **6 flash** error code. After 1 hour the SmartValve will try again at the beginning of the sequence for 4 more tries. The SmartValve can cycle this way indefinitely as long as a call for heat is present.
12. Main burner remains on until water reaches set-point.
13. SmartValve de-energizes gas valve, main burner goes out.
14. Blower post purges 5 seconds and then stops.
15. Blocked exhaust switch contacts open.
16. Heater goes into standby mode.

SMARTVALVE™ TROUBLESHOOTING

When following the Troubleshooting procedures in this manual, keep in mind that each Step carries the presumption that the previous Steps have been performed and the results were successful. Failing to perform the previous Steps may lead to misdiagnosis.

The two most common problems associated with SmartValve equipped water heaters are often the result of an installation requirement that was overlooked. The two items below are the most common problems with operation, followed by the most frequent causes.

1. Burner Short Cycles

- **Reversed polarity or Burner is not grounded**

See Troubleshooting Steps 1A, 1B, 1C

- **Flame Sense Rod alignment or condition**

See Troubleshooting Step 7

- **Vent pipe (s) exceeds length or maximum number of elbows limitation**

1. Review the venting limitations on pages 4 - 5, correct the vent system (ie: use larger size vent pipe)
2. See Troubleshooting Steps 4A, 4B

- **Heater is powered by GFI breaker or outlet, or on the same breaker as a fluorescent lighting fixture**

Try other outlets with an extension cord – **ensure the other outlets have correct polarity and are properly grounded before trying this test**

2. Burner Doesn't Light - Igniter (HSI) Does Not Receive Power

1. Review the venting limitations on pages 4 - 5, correct the vent system (ie: use larger size vent pipe)
2. See Troubleshooting Step 3
3. See Troubleshooting Steps 4A, 4B
4. Is there enough Make-Up air being provided into the room? Open doors/windows leading into the room

SMARTVALVE™ TROUBLESHOOTING NOTES

1. If the sequence of operation advances beyond the point (step 8, page 27) where the blocked exhaust switch contacts close the “air proving switch circuit”, the SmartValve then enters the ignition portion of the sequence. If any safety-limit switch (ie: blocked exhaust, blocked inlet-FPD models, or vent temperature limit) contacts within this circuit re-open after this point, the SmartValve will interpret this as a failed trial for ignition or a loss of flame before set-point was reached. The SmartValve will try to ignite and satisfy a call for heat 4 times before locking out for 1 hour and displaying a 6 flash error code.
2. Depending on model and “series number” (see venting information page 3) some SmartValve equipped water heaters will also have a “Vent Temperature Limit Switch” attached to the blower housing near the exhaust outlet, some will not. If present, this vent temperature limit switch will be wired in one of two ways:
 - a. In series with the blocked exhaust switch as part of the air proving switch circuit as shown in Figure 1.
 - b. In series with the blower motor’s 115 VAC neutral wire as shown in Figure 2.
3. If the vent temperature limit switch contacts remain open, either the blower motor will not start or the air proving switch circuit will not close depending on how the switch is wired into the control circuit. This could lead to a 3 or a 6 flash error code depending on when the vent temperature switch contacts open. Keep this switch and the two different methods of wiring in mind when performing any troubleshooting procedures.

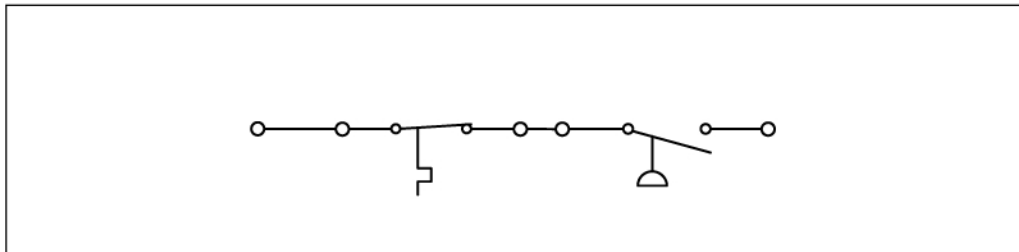

Figure 1

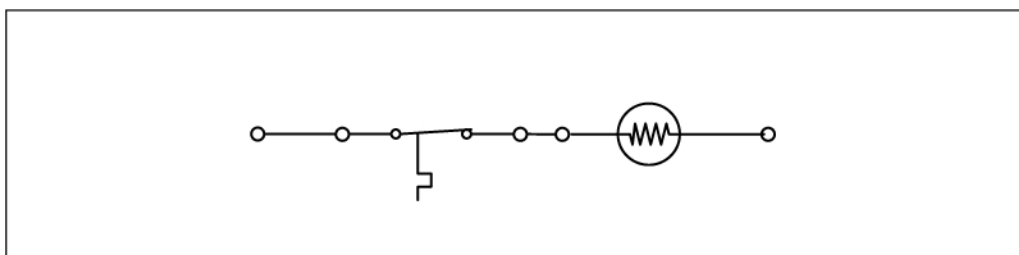

Figure 2

TROUBLESHOOTING NOTES - Continued

IDENTIFYING THE 6 PINS ON THE WIRING HARNESS PLUG

On the opposite side of the **wiring harness plug** from its retaining clip there are raised ridges which identify pins 1, 2, and 3 with a corresponding number of ridges as illustrated below. Once you have identified pins 1 – 3, pins 4 – 6 can be identified by referring to the illustration. One end of the wiring harness plugs into the blower control box and the other end plugs into the “C1” receptacle on the SmartValve.

Keep in mind the **female receptacle** that the wiring harness plugs into on the SmartValve and the blower wiring box is a mirror image of the wiring harness plug.

- 1 = Air Proving Switch Circuit
- 2 = Blower 115 VAC Hot Wire
- 3 = 115 VAC Supply Hot Wire to SmartValve
- 4 = Air Proving Switch Circuit
- 5 = Blower 115 VAC Neutral Wire
- 6 = 115 VAC Supply Neutral Wire to SmartValve

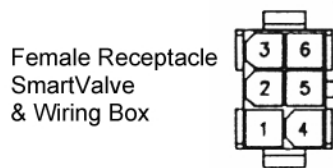
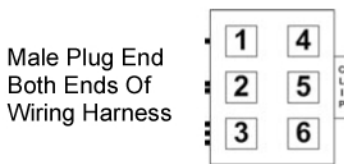
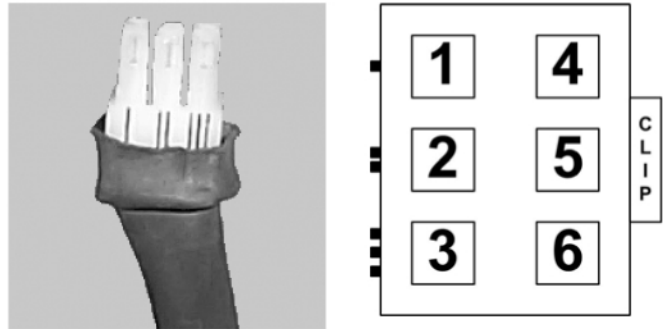

- 1=AIR PROVING SWITCH
- 2=BLOWER- HOT
- 3=120V – HOT
- 4=AIR PROVING SWITCH
- 5=BLOWER – NEUTRAL
- 6=120V-COMMON

IDENTIFYING THE 4 PINS ON THE IGNITER PLUG

Identify the 4 pins on the Hot Surface Igniter plug referencing the illustration below. This plug has pins 1, 2, and 3 identified in the same way as noted above. This connector plugs into the “C2” receptacle on the SmartValve

- 1 = Igniter 115 VAC Hot wire
- 2 = Unused
- 3 = Igniter 115 VAC Neutral wire
- 4 = Flame Sensor wire

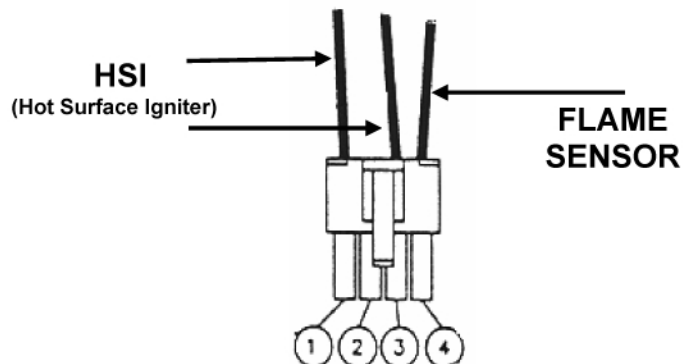

SMARTVALVE™ TROUBLESHOOTING GUIDE
A O Smith Models: FPD, FPSH, FPCR, FPST, FPSE, BTI, BTF with SmartValve

| LED | INDICATES / CONDITION | CHECK / REPAIR |
|----------------------------|--|--|
| Off | No power to control. | <ol style="list-style-type: none"> 1. Appliance On/Off switch in the off position. 2. Check for 115 volts at wall outlet. 3. Check for 115 volt power to SmartValve between pin 3 and 6 on wiring harness plug. 4. Check system wiring harness and connections. |
| Bright - Dim | Normal operation. | Normal operation. |
| 1 Flash | Set-point error-internal failure detected. | 1. Replace SmartValve control. |
| 2 Flashes | Blocked exhaust switch contacts remain closed longer than 30 seconds after a call for heat begins. Blower will not start. Switch contacts should have opened after previous cycle. | <ol style="list-style-type: none"> 1. Blocked exhaust switch stuck closed. 2. Blocked exhaust switch miswired or jumpered. |
| 3 Flashes | <p>Blocked exhaust switch contacts remain open longer than 30 seconds after blower receives power.</p> <p>Blocked intake switch (FPD only) contacts remain open longer than 30 seconds after blower receives power.</p> <p>Vent temperature limit switch (if so equipped) contacts remain open longer than 30 seconds after the blower receives power.</p> <p>Blower stops, system goes into a 5 minute lockout with 3 flashes displayed. After 5 minute delay system will try again at beginning of sequence. SmartValve can cycle this way indefinitely.</p> | <ol style="list-style-type: none"> 1. Vent system length (equivalent feet) exceeded, too many elbows installed in vent system. 2. Blocked intake/exhaust switch tubing pulled off. 3. Blocked intake/exhaust switch remains open after set-point is reached - check with manometer or draft gage, replace intake/exhaust proving switch if defective. 4. Obstruction or restrictions in exhaust/intake pipe. 5. Vent temperature limit switch not cooled below 135°F - run blower - wait until switch cools down. 6. Vent temperature limit switch contacts stuck open - replace vent temperature limit switch. 7. Check that flue baffle is hung correctly and that flue restrictor (if so equipped) is also in place. |
| 4 Flashes | Thermal cutoff (ECO) open - internal failure. Blower remains energized. | 1. Replace SmartValve control. |
| 5 Flashes | Flame signal sensed out of proper sequence. Blower remains energized. (during flame sense) | <ol style="list-style-type: none"> 1. Determine if flame is out of sequence - replace SmartValve control. 2. Check igniter wires are not loose at SmartValve. |
| 6 Flashes | <p>System Lockout.</p> <p>4 trials for ignition failed or 4 loses of flame occurred before set-point was reached.</p> <p>After 1 hour "soft" lockout, SmartValve control will initiate a new ignition sequence if the call for heat is still present. (SmartValve can cycle this way indefinitely.)</p> <p>*Cycle power or a call for heat off & on for 2 seconds to reset SmartValve control.</p> | <ol style="list-style-type: none"> 1. Reversed polarity in 115 volt power supply. 2. Heater/burner not properly earth grounded, check pin 3 on wire harness plug (valve end) to burner tube for 115 volts, check ground path to burner. 3. Ground fault interruption (GFI) breaker causing intermittent operation, try non-GFI outlet. 4. Flame sense rod dirty or incorrectly positioned. 5. Vent system length exceeded, too many elbows, blocked exhaust/intake switch opens after light off. 6. Flame sense/HSI wiring condition/connections. 7. Low or no supply gas pressure. 8. Fluorescent lighting on same breaker as heater. 9. Damaged, defective, or incorrectly positioned HSI. |
| Continuous rapid blinking. | <p>Water in tank is below 36° F.</p> <p>Circuit board in SmartValve is cracked.</p> | <ol style="list-style-type: none"> 1. Increases water temperature. 2. Replace SmartValve control. |

STEP 1 - ELECTRICAL OUTLET TEST (Polarity, Voltage, Ground, and Wiring)

STEP 1 Outlet Power, Polarity, & Ground Test. With a volt meter check for 115-125 VAC on the wall outlet serving the water heater:

1. - between the “neutral” and “ground”; should be 0 volts.
2. - between the “hot” and “ground”; should be 120 VAC.
3. - between the “neutral” and “hot”; should be 120 VAC.

| If ... | Then |
|--|---|
| “Neutral” to “Ground” test indicates 120 VAC | <ul style="list-style-type: none"> ▪ check wiring to the outlet - polarity is reversed - correct wiring to outlet. |
| “Neutral” to Ground indicates 0 VAC | <ul style="list-style-type: none"> ▪ This is correct - continue |
| “Hot” to “Ground” indicates 0 VAC. | <ul style="list-style-type: none"> ▪ check outlet wiring for correct polarity ▪ check ground wire connection to outlet ▪ check hot wire connection to outlet ▪ check breaker feeding outlet |
| “Hot” to “Ground” indicates 120 VAC. | <ul style="list-style-type: none"> ▪ This is correct - continue |
| “Hot” to “Neutral” indicates 0 VAC. | <ul style="list-style-type: none"> ▪ check hot wire connection to outlet ▪ check neutral wire connection to outlet ▪ check breaker feeding outlet |
| “Hot” to “Neutral” indicates 120 VAC. | <ul style="list-style-type: none"> ▪ This is correct – Go to Step 2 |

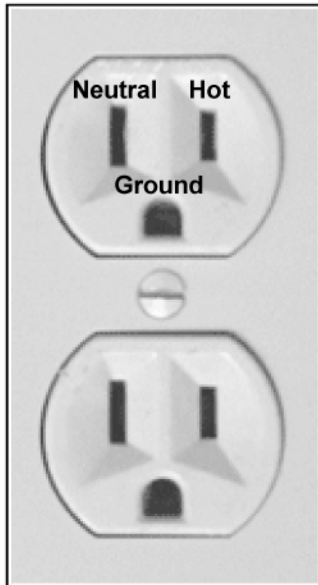

THE WALL OUTLET MUST BE WIRED AS SHOWN ON THE LEFT.

SERVICE NOTES:

- If the Neutral and Hot wires are reversed the burner will short cycle.
- If there is no ground to the outlet the burner will short cycle.
- If no voltage can be read between Hot and Ground and 120 VAC is present between Hot and Neutral, the outlet is not properly grounded.
- GFI outlets and circuit breakers may cause burner short cycling – keep in mind one GFI outlet often feeds several other outlets in the home, the one you are working on may not be a GFI itself, but may be fed from another GFI outlet in the home. **NEC code does not require a GFI outlet on “appliances that run for long periods of time unattended”** even when the water heater is located in a basement or garage. However, a single plug outlet will be required in areas that would otherwise require a GFI to satisfy this NEC exception.
- Fluorescent lighting being on the same circuit breaker with the outlet feeding the water heater can also cause short cycling.

* Try a different outlet in the home with an extension cord when a GFI or Fluorescent lighting condition is suspected. However, **always check for correct polarity and ground at the other outlet first** or you may “swap” one problem for another that will also cause the burner to short cycle.

STEP 2 – GROUND PATH TEST

Flame sensing is electrical current “flowing” from the Flame Sense Rod through the flame itself to ground via the burner. If the burner is not grounded, flame sensing current will not flow and the main burner flame will short cycle. The grounding “path” to the burner must travel from the wall outlet through the appliance cord (green wire) and the jacket of the heater before it reaches the burner. There are several connections and metal to metal contact points that have been painted where this “ground path” can breakdown. This test will confirm the ground path to the burner through the heater is continuous. **Unplug the water heater from the wall outlet for this test.**

STEP 2 Ground Path Test. With an ohm meter check for continuity between the ground prong on the end of the appliance cord and the burner tube.

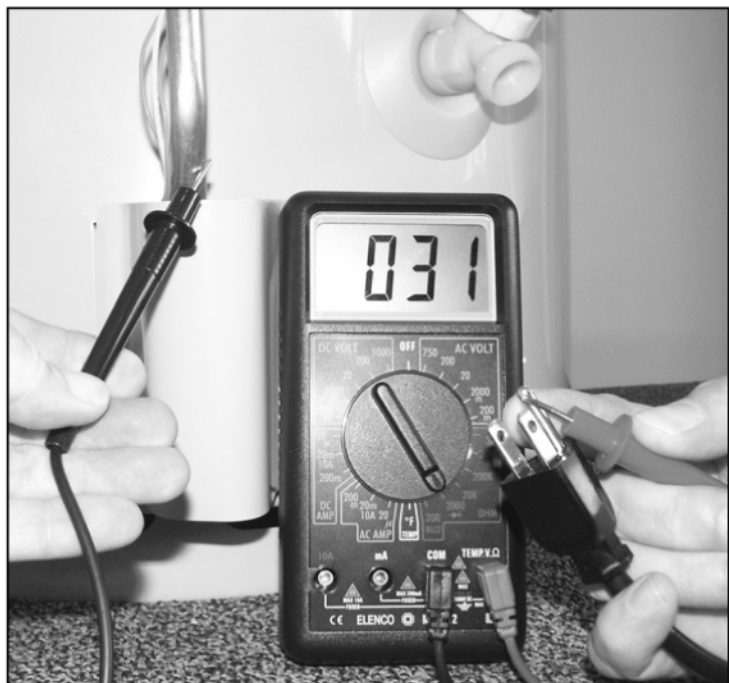
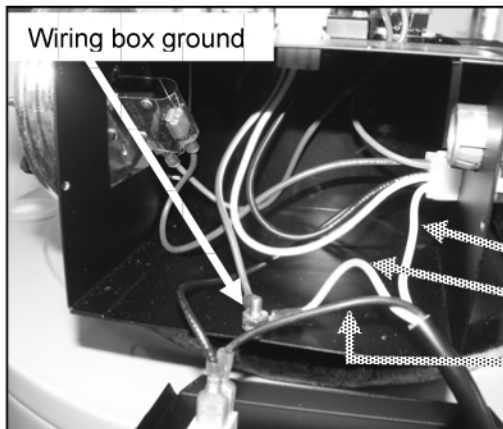
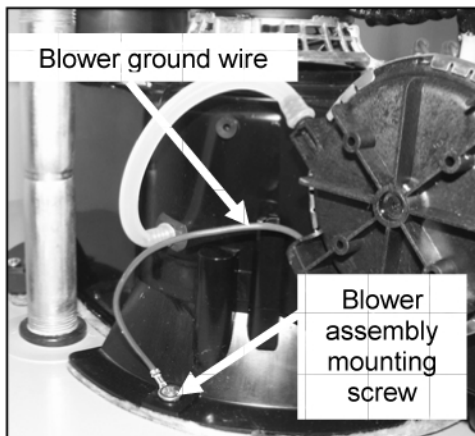

1. Neutral wire from appliance cord.
2. Ground wire from appliance cord.
3. Hot wire from appliance cord – feeds to the on/off switch.

| If ... | Then |
|--|---|
| Continuity is not present between the ground prong on the appliance cord and the burner tube. | <ul style="list-style-type: none"> • check ground wire (green) continuity through appliance cord. • check ground connection inside blower wiring box. • check ground wire between blower wiring box connection and blower assembly mounting screw. • run an temporary ground wire between SmartValve body screw (Torx type screw) and known earth ground source until ground path problem is corrected. |
| Continuity is present. | <ul style="list-style-type: none"> • This is correct - Go to step 3 |

STEP 3 – WIRING HARNESS POLARITY TEST

Unplug the six pin plug at the SmartValve. Perform Step 3 at this end of the wiring harness with heater plugged into an outlet and the on/off switch turned “on”.

STEP 3 Wiring Harness Polarity test. Check for 115-125 VAC between Pin 6 (Neutral) wire of the cable and ground. Should read 0 volts.

| If ... | Then |
|--|--|
| Pin 6 (Neutral) to ground test indicates 120 VAC | <ul style="list-style-type: none"> • check polarity to the heater at wall outlet • check appliance cord connections inside wiring box for correct polarity. Hot feeds on/off switch • unplug both ends of the wiring harness - check wiring harness continuity on all 6 wires |
| Pin 6 (Neutral) to ground test indicates 0 VAC | <ul style="list-style-type: none"> • This is correct - Go to step 4 |

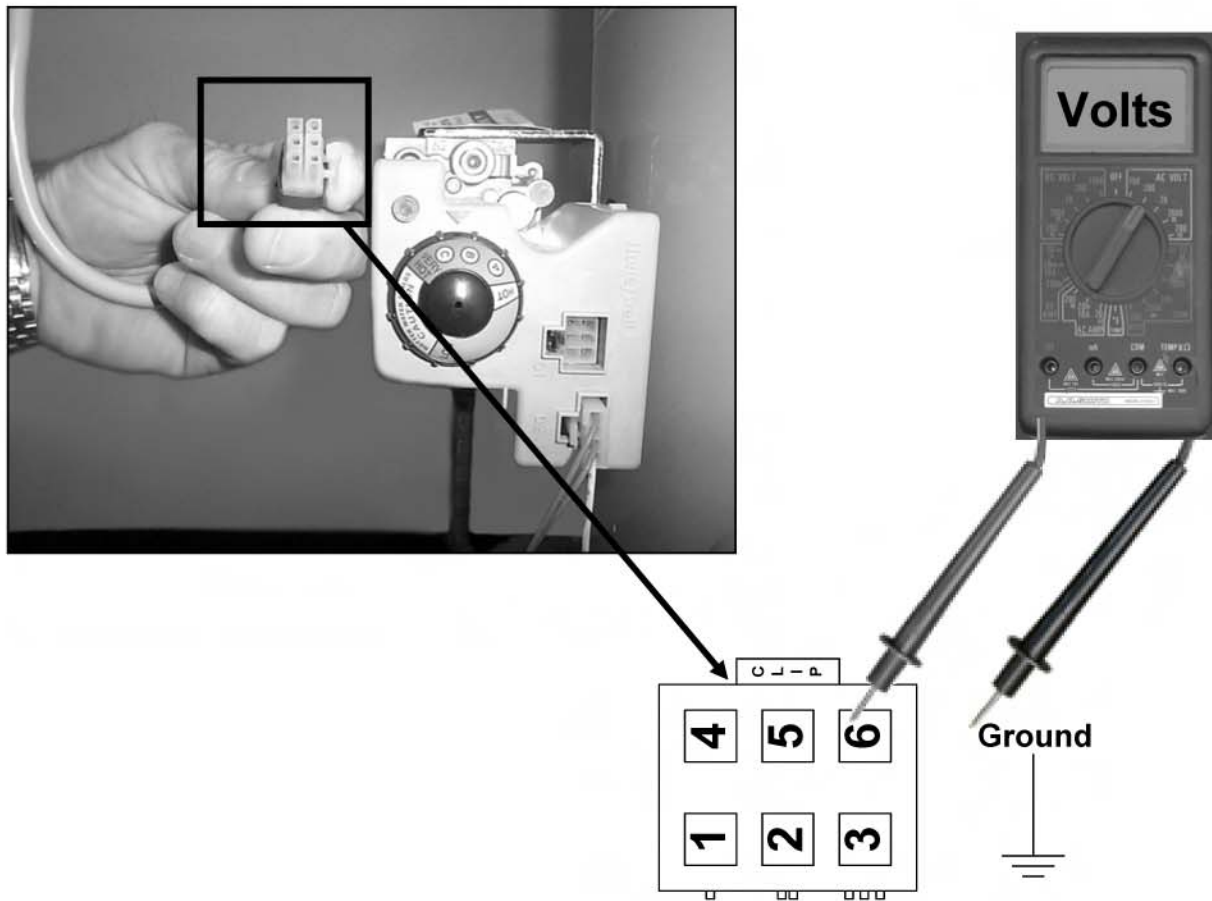

STEP 4 – WIRING HARNESS VOLTAGE AND GROUND TEST

Unplug the six pin plug at the SmartValve. Perform Step 4 at this end of the wiring harness with heater plugged into an outlet and the on/off switch turned “on”.

STEP 4 Wiring Harness Voltage and Ground Test. Check between Pin 3 (Hot) of the wiring harness plug and the *burner tube (ground). Should read 115 – 125 VAC.

| If ... | Then |
|--|--|
| Pin 3 (Hot) to *burner tube test does not indicate 120 VAC | <ul style="list-style-type: none">• check supply power from outlet (Step 1)• power switch position• check ground to heater and burner - see Steps 1 and 2• cable to blower control box connection• check wiring harness continuity |
| Pin 3 (Hot) to burner tube test does indicate 120 VAC | <ul style="list-style-type: none">• This is correct – Go to Step 5 |

*Burner must be grounded to sustain flame sensing current, a reading of 115 - 125 VAC between burner tube and pin 3 will verify ground at the burner is adequate. See Steps 1 and 2.

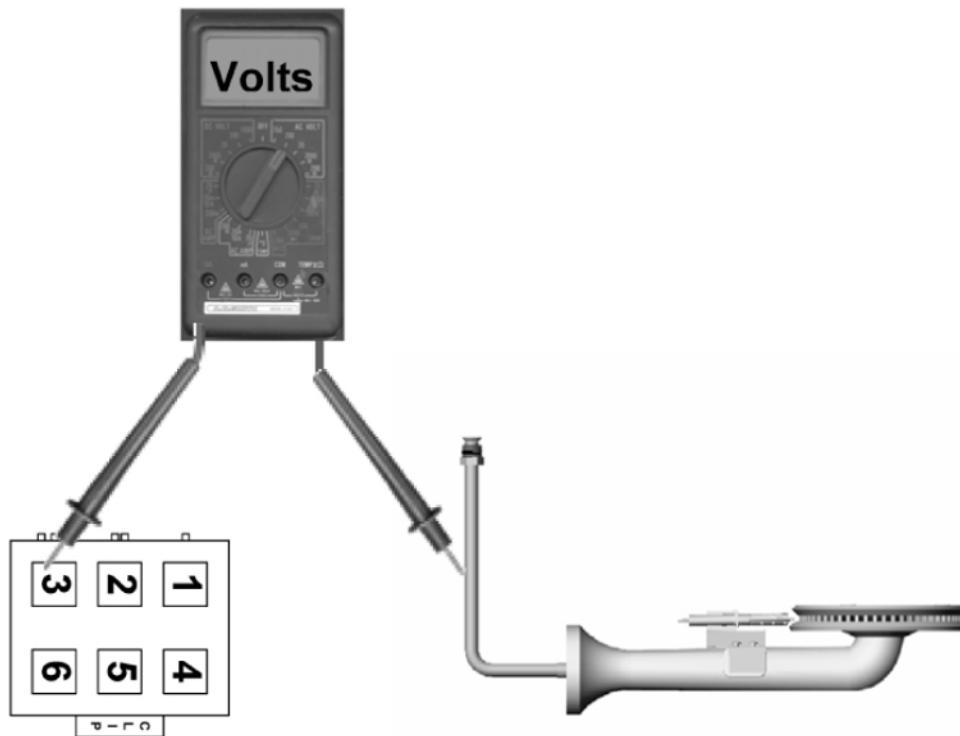

STEP 5 – WIRING HARNESS POWER TEST

Unplug the six pin plug at the SmartValve. Perform Step 5 at this end of the wiring harness with heater plugged into an outlet and the on/off switch turned “on”.

STEP 5 Wiring Harness Power Test. Check between Pin 3 (Hot) and Pin 6 (Neutral) of the wiring harness plug. Should read 115 - 125 VAC.

| If ... | Then |
|---|--|
| Pin 3 (Hot) to Pin 6 (Neutral) does not indicate 120 VAC | <ul style="list-style-type: none">▪ check wiring harness plug connection at blower control box – inspect plug and receptacle pins inside connectors for proper contact and wear▪ check “Neutral” wiring inside blower control box▪ unplug both ends of the wiring harness - check wiring harness continuity on all 6 wires |
| Pin 3 (Hot) to Pin 6 (Neutral) does indicate 120 VAC | <ul style="list-style-type: none">▪ This is correct - Go to step 6 |

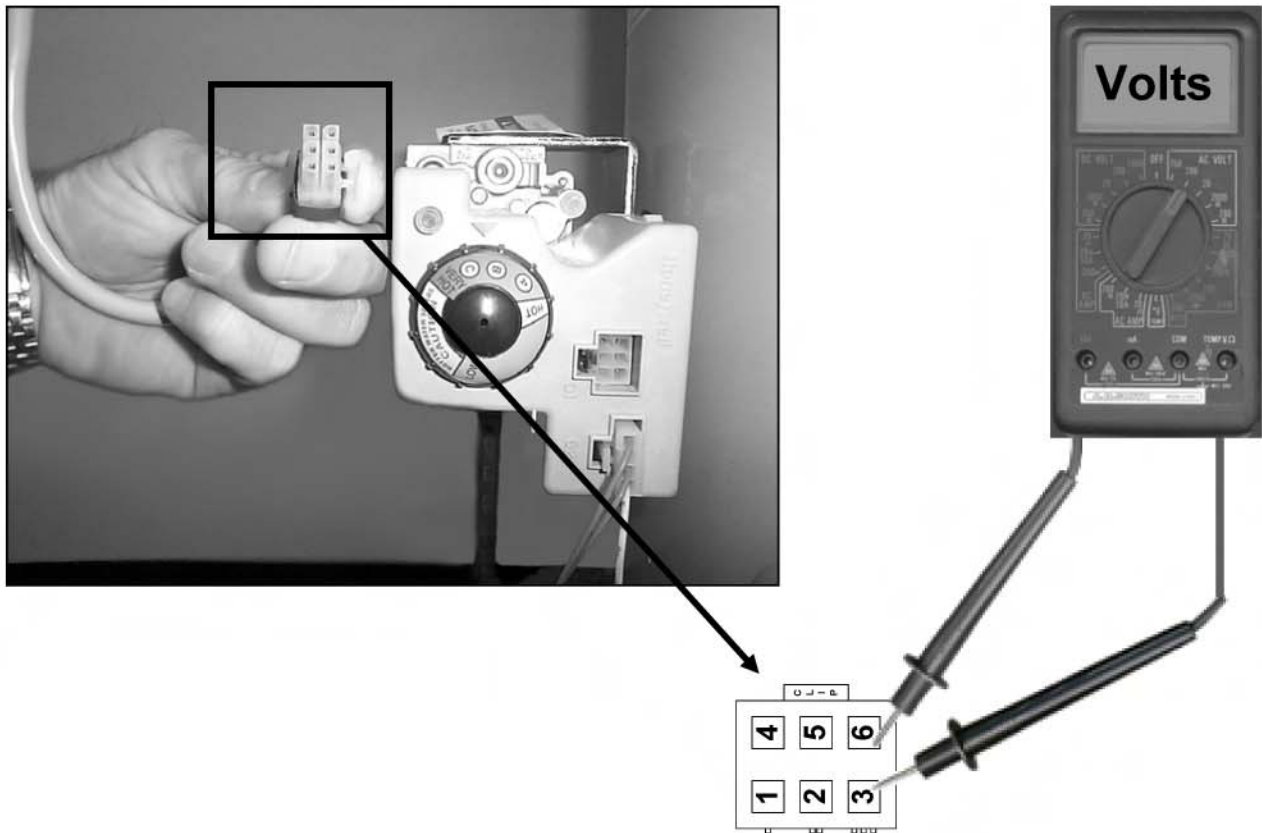

STEP 6 - BLOCKED EXHAUST - BLOCKED INLET SWITCH TEST

Unplug water heater power cord from wall outlet; turn the on/off switch to the “off” position. Open blower wiring box, **disconnect the wires to the Blocked Exhaust Switch (all models) and to the Blocked Inlet Switch (FPD models only)**. Use an ohm meter to perform this continuity test. All models will have a Blocked Exhaust Switch, only FPD models will have a Blocked Inlet Switch. Test results are opposite for these two switches.

STEP 6 Check between the two terminals of the “normally open” Blocked Exhaust switch on all models and between the two terminals of the “normally closed” Blocked Inlet Switch on FPD models with an ohm meter.

| If ... | then |
|--|--|
| continuity is present terminal to terminal of the Blocked Exhaust Switch - all models | replace switch - it should have open contacts in it's normal state |
| continuity is not present terminal to terminal of the Blocked Exhaust Switch | Blocked Exhaust Switch continuity is ok, continue |
| continuity is not present terminal to terminal of the Blocked Inlet Switch - FPD models only | replace switch - it should have closed contacts in it's normal state |
| continuity is present terminal to terminal of the Blocked Inlet Switch | Blocked Inlet Switch continuity is ok, Go to step 7 |

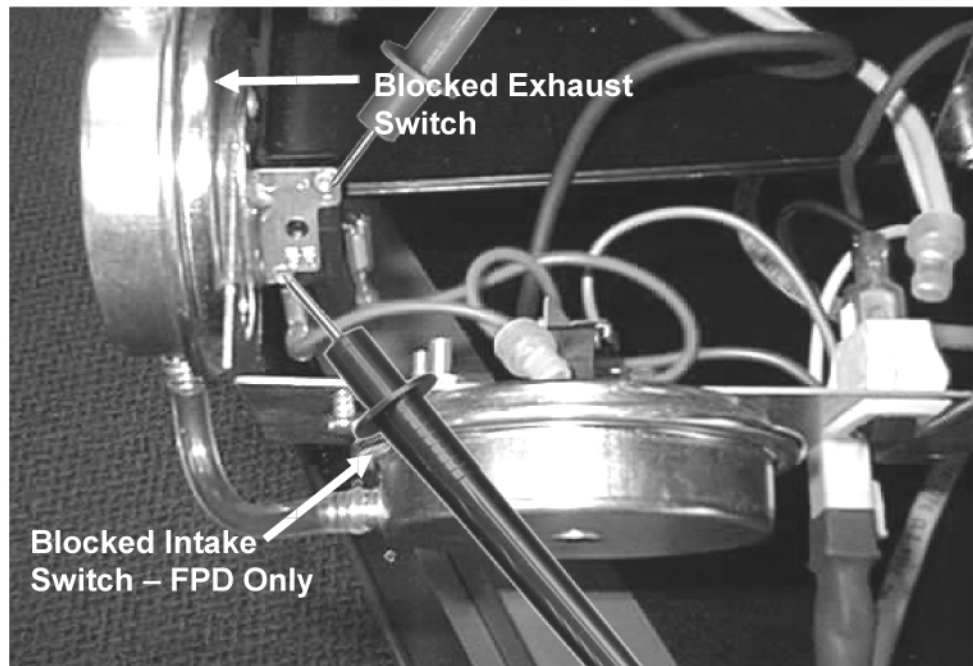
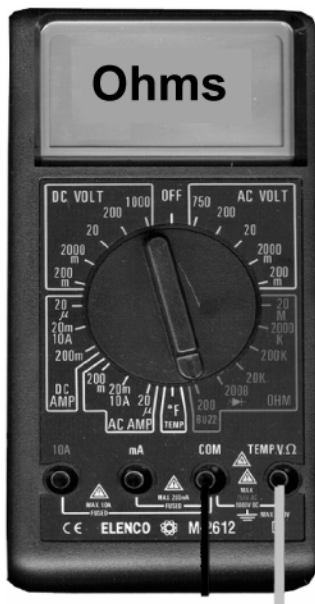

STEP 7 - VENT TEMPERATURE LIMIT SWITCH CONTINUITY TEST

Unplug water heater power cord from wall outlet, turn the on/off switch to the “off” position. Disconnect the wires to the vent temperature limit switch. Use ohm meter to perform a continuity test. **Make sure the temperature limit switch is at room temperature before performing this test.**

STEP 7 Check between the two wiring terminals of the vent temperature limit switch with an ohm meter.

| If ... | then |
|--|--|
| continuity is not present terminal to terminal of the vent temperature switch | <ul style="list-style-type: none"> replace switch-it should be closed |
| continuity is present terminal to terminal of the vent temperature switch | <ul style="list-style-type: none"> Switch continuity is ok - Go to step 8 |

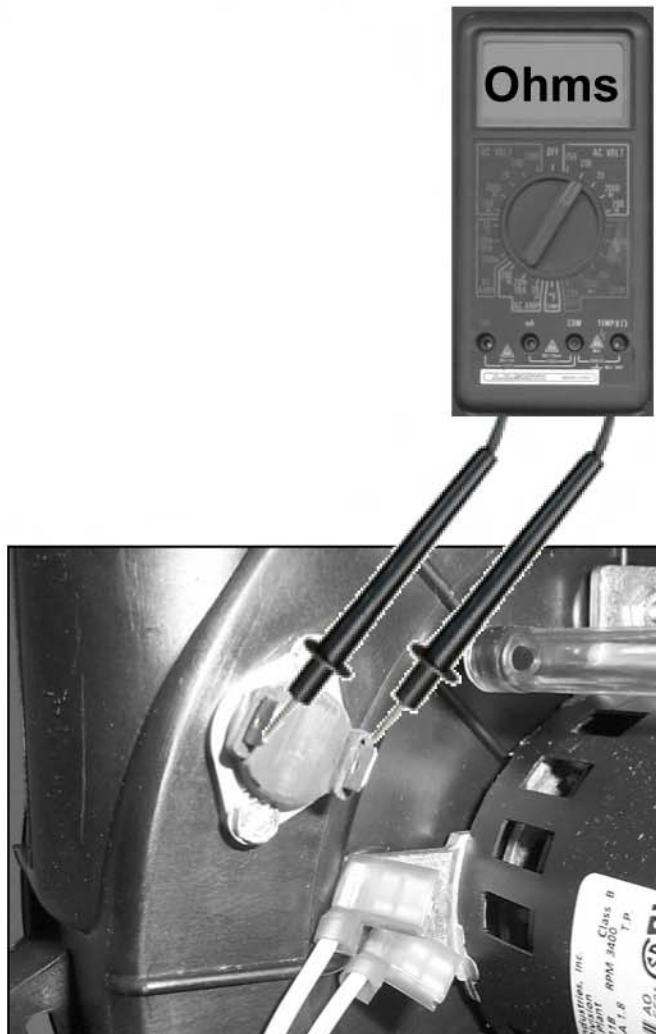

SERVICE NOTE:

If the Vent Temperature Limit Switch is opening its contacts and/or the heater's exhaust vent or blower assembly show any signs of overheating – check the flue baffle and the flue restrictor (shown here)

Ensure that both the flue baffle and the flue restrictor are properly installed and seated on the flue pipe.

Also check the screen on the air intake of the blower assembly, keep this screen clear of lint and debris.

STEP 8 - AIR PROVING CIRCUIT TEST

Reconnect the wiring harness and all other wiring. Turn the on/off switch to the “on” position. **An ohm meter and a draft gauge or digital manometer capable of accurately reading 100ths of an inch of water column are required for this test.**

STEP 8A Air Pressure Test. Connect a draft gauge or digital manometer to the sensing port on the blower housing directly, record the pressure reading after the blower comes up to speed and compare it to the chart on the next page. Follow the instructions below if the recorded pressure does not reach the “make point” at which the Blocked Exhaust Switch contacts close for that particular model and series, or if pressure exceeds the “break point” at which the Blocked Inlet Switch (FPD models only) opens its contacts.



| If ... | then |
|--|---|
| Pressure reading taken does not reach the make point shown on the following page for the Blocked Exhaust Switch on your model and series heater, or the pressure reading taken exceeds -0.70" W.C. negative pressure on FPD models equipped with a Blocked Inlet Switch. | <ul style="list-style-type: none"> • check/clean dilution air inlet screen/grill on blower (FPD models do not have dilution air inlet) • check the vent system for restrictions or debris. • check the vent system for maximum equivalent feet and/or max number of elbows (see page 4). • insure the flue baffle and flue restrictor are in good condition and installed correctly. • insure there is enough make up air provided into the space - open windows and doors see if pressure reading changes. • check blower wheel for dirt - clean as necessary. |
| Pressure reading taken is within values given on next page | <ul style="list-style-type: none"> • vent system pressure is ok – Go to Step 8B |

STEP 8 - AIR PROVING CIRCUIT TEST – Continued

Air Proving Switch Chart - Use this chart to verify air proving switch performance with pressure readings taken in step 8A.

If the air pressure did not reach the specified pressure for the Blocked Exhaust Switch to close its contacts, **the switch is not defective**, closely examine the vent length and number of 90° elbows used, compare it with the venting chart on page 4, ensure the flue baffle and flue restrictor are properly installed, ensure the vent system is not blocked.

FPD models will have a second Blocked Intake Switch, if the negative air pressure measured in Step 8A exceeds -0.7 negative pressure (draws into a deeper vacuum) the normally closed contacts of this switch would open and prevent the heater from firing, **the switch is not defective**, closely examine the inlet air piping for exceeding maximum equivalent feet of pipe or max number of elbows – compare with venting chart on page 4.

| Model | Series | Blocked Exhaust Switch Normally Open - N.O. | Blocked Intake Switch Normally Closed - N.C. |
|------------|-----------------|--|---|
| | | Contacts Close At | Contacts Open At |
| FPD | 250 - 253 | -0.10" W.C. negative pressure | -0.70" W.C. negative pressure |
| FPST | 250 - 253 | -0.04" W.C. negative pressure | N/A |
| FPSH 40/50 | 250 - 253 | -0.04" W.C. negative pressure | N/A |
| FPSH 40/50 | 260, 261 | -0.61" W.C. negative pressure | N/A |
| FPSE 75 | 250 - 253 | -1.27" W.C. negative pressure | N/A |
| FPSH 75 | 260, 261 | -1.57" W.C. negative pressure | N/A |
| BTF | 100, 101 | -1.27" W.C. negative pressure | N/A |
| BTF | 104, 105 | -1.57" W.C. negative pressure | N/A |
| BTI | 100 - 105 | -0.49" W.C. negative pressure | N/A |

SERVICE NOTE: LEAKING AIR PROVING SWITCH DIAPHRAGMS.

FPD model heaters are equipped with 2 air proving switches. It is possible for one of the two air pressure switch diaphragms to leak causing erratic pressure readings and misdiagnosis when troubleshooting. Before condemning an air proving switch on a FPD model determine if either of the two air proving switches diaphragms are leaking.

Connect a draft gauge/digital manometer with a "T" fitting (available at most auto/HVAC parts stores) in-line with the plastic sensing tube from each air proving switch one at a time. Take pressure readings with and without each of the switches in-line. When the blower comes up to speed the pressure readings are normally in a slight vacuum. If the pressure reading is "higher" (more towards a positive pressure) with one switch in line than it was with the gauge connected directly to the blower sensing port, that pressure switch diaphragm is leaking and the switch must be replaced.

SERVICE NOTE: *Digital draft gauges are available from many instrument manufacturers and can be used to measure air proving switch performance. Ensure whatever instrument you use is capable of accurately measuring within the range of pressure you expect to encounter and to within 1/100th of an inch of water column.*

STEP 8 - AIR PROVING CIRCUIT TEST – Continued

Open blower wiring box and disconnect all wires to the air pressure switches. Perform this test with the blower running. **Do not disconnect the plastic air sensing tube (s) from the switches or the blower housing.**

STEP 8B Continuity Test. Disconnect all the wires to the Blocked Exhaust Switch and the Blocked Inlet Switch (FPD models). **Do not allow any wiring to touch ground while performing this test. Tape off air pressure switch wiring connectors with electrical tape.** Start the water heater; allow the blower to come up to full speed, with an ohm meter (alligator clip meter probe attachments are recommended for “hands free” testing) check continuity between the two terminals of the Blocked Exhaust Switch and the Blocked Inlet Switch on FPD models.

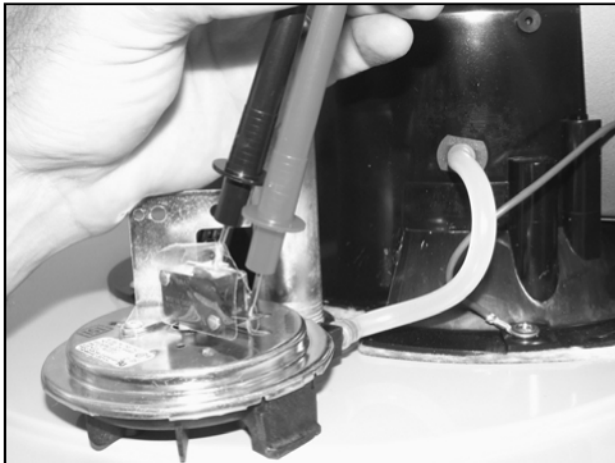

Blocked Exhaust Switch FPSH 260 Series



Blocked Inlet Switch FPD 251 Series

| If ... | then |
|--|--|
| Continuity is not present terminal to terminal of Blocked Exhaust Switch and pressure reading taken in Step 8A was within parameters for this model and series. | <ul style="list-style-type: none"> ▪ replace Blocked Exhaust Switch |
| Continuity is present terminal to terminal of Blocked Exhaust Switch during test. | <ul style="list-style-type: none"> ▪ FPD models – continue ▪ All other models – Go to Step 9 |
| Continuity is not present terminal to terminal of Blocked Inlet Switch and pressure reading taken in Step 8A did not exceed -0.70" W.C. negative pressure. | <ul style="list-style-type: none"> ▪ replace Blocked Inlet Switch |
| Continuity is present terminal to terminal of Blocked Inlet Switch during test. | <ul style="list-style-type: none"> ▪ This is correct – Go to Step 9 |

STEP 9 - IGNITER RESISTANCE TEST

Unplug water heater power cord from wall outlet, turn the on/off switch to the "off" position. Disconnect the 4 pin igniter plug from the "C2" receptacle on the SmartValve.

Make sure the igniter is at room temperature before performing this test.

STEP 9 Check for 50 - 300 ohms resistance between pins 1 and 3 of the HSI plug.

| If ... | then |
|------------------------------------|-------------------|
| 50-300 Ohm's is not present | replace assembly. |
| 50-300 Ohm's is present | Go to Step 10. |

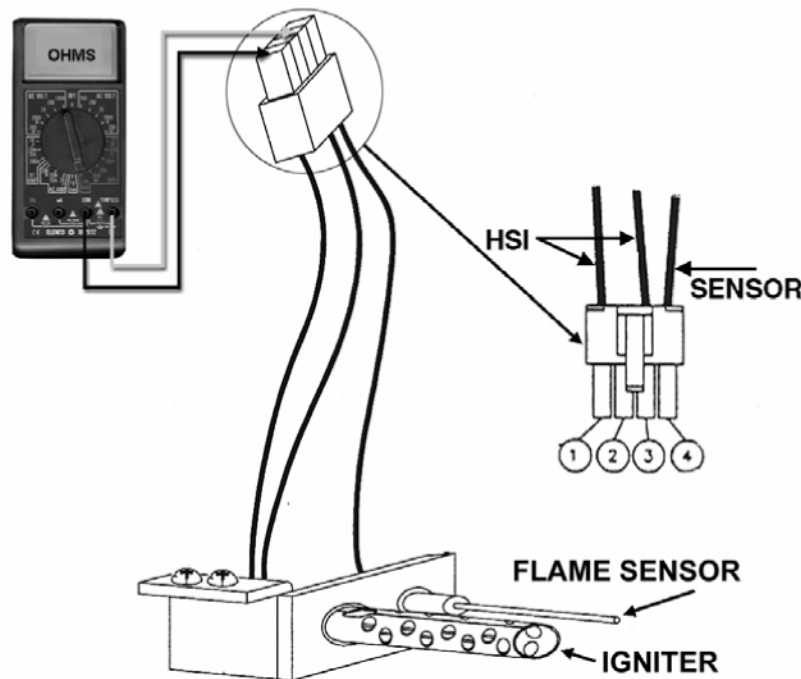

SERVICE NOTE: The ohms resistance readings will vary with temperature; be sure to make this resistance test with the igniter at room temperature. Igniter's cold resistance will increase with age and wear. If a unit has been intermittently failing to ignite and the ohms reading taken is on the high end of the tolerance given, discuss replacing the igniter with the customer.

STEP 10 - IGNITER POWER TEST

Make sure all wires are reconnected that were disconnected in previous steps. Plug power cord into wall outlet and turn the on/off switch to the "on" position. Within 35 seconds of the blower starting the igniter should receive 120 VAC and begin to glow.

STEP 10 Check for 115 - 125 VAC on control between Pin 1 and Pin 3 of the HSI "C2" plug.

| If ... | then |
|--|---|
| 120 VAC is not present within 35 seconds of blower starting | <ul style="list-style-type: none"> ▪ replace control - only if Steps 6,7, and 8 have been performed and results were successful |
| 120 VAC is present within 35 seconds of blower starting | <ul style="list-style-type: none"> ▪ check plug and wires to igniter ▪ replace HSI assembly if igniter does not glow. ▪ Go to Step 11. |

SERVICE NOTE: Keep in mind that the Blocked Exhaust Switch must close its contacts after the blower is energized before the SmartValve will provide 120 VAC to the igniter. SEE STEPS 6, 7, AND 8 - do not replace the SmartValve for failing to energize the igniter without performing these tests first.

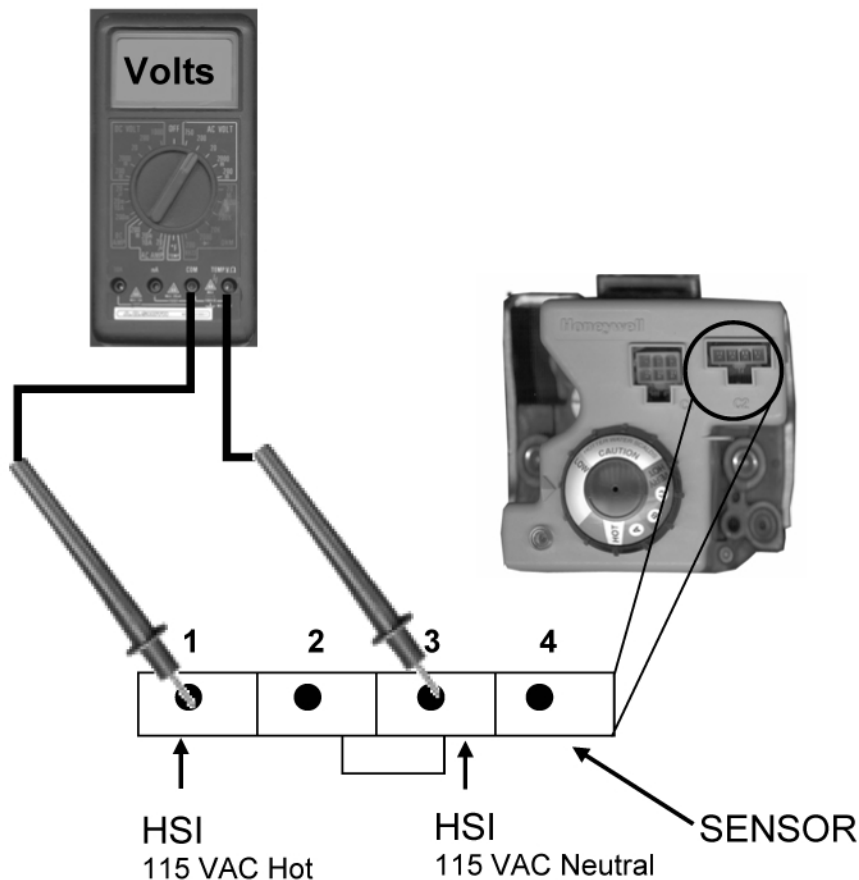

STEP 11 – IGNITER ASSEMBLY CHECK

Unplug water heater power cord from wall outlet, turn the on/off switch to the “off” position. Close the supply gas valve to heater, disconnect the C2 plug on the SmartValve. Remove the burner assembly from the heater.

STEP 11 With the burner removed; inspect and adjust the Flame Sensing Rod or replace the Igniter assembly as directed below. Making any one of these four adjustments along with correcting reversed polarity and grounding problems (Steps 1 - 5) may correct a short cycling Burner problem. **The Flame Sense Rod shown below is on a propane model; natural gas models will have a 90° angle bend at the end of the rod as shown in the drawings on pages 11, 14, and 15.**



11A check the gap between the Flame Sense Rod and the edge of the burner, it should be $7/64$ " to $1/4$ ". A nickel will work to set a $7/64$ " gap, carefully bend the bracket to adjust the gap.

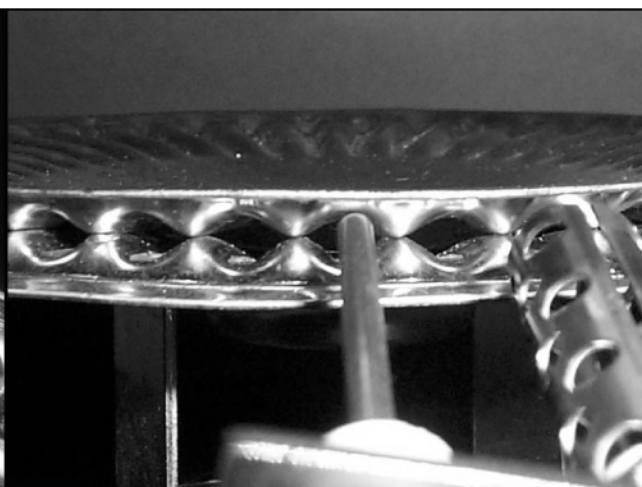

11B check the positioning of the Flame Sense Rod in relation to the Burner, the rod must be positioned directly in front of one of the Burner ports, carefully bend the bracket to adjust.



11C inspect the Flame Sense Rod for any signs of rust or corrosion, this can cause a short cycling Burner. Clean the Flame Sense Rod with a piece of steel wool or Emory cloth.

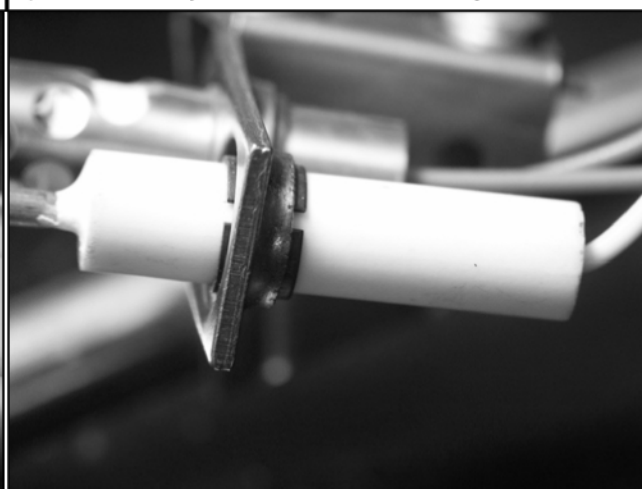

11D inspect the porcelain insulator on the Flame Sense Rod and the wires to the assembly; if the insulator has any cracks or the wires are damaged or worn – replace the igniter assembly.

STEP 12 - GAS PRESSURE TEST

Make sure all wires are reconnected that were disconnected in previous steps. Plug power cord into wall outlet and turn the on/off switch to the "on" position. During igniter activation period the gas valve should open. **A manometer or gas pressure gauge is required for this test.**

STEP 12 Check manifold gas pressure at manifold pressure tap on SmartValve with manometer during a trial for ignition after the Igniter receives power.

| If ... | then |
|--|---|
| There is not any manifold gas pressure to main burner during trial for ignition | <ul style="list-style-type: none"> ▪ ensure there is supply gas present ▪ ensure supply gas shutoffs are open ▪ ensure gas line is not clogged or restricted ▪ adjust manifold gas pressure at valve ▪ replace control |
| Manifold gas pressure is noted during trial | <ul style="list-style-type: none"> ▪ verify proper pressure per chart below ▪ adjust manifold gas pressure at valve ▪ verify that air in gas line has been purged ▪ verify burner orifice size ▪ verify burner orifice is not restricted |

| Manifold Gas Pressure | |
|-----------------------|------------|
| Natural | 3.5" w.c. |
| Propane | 10.0" w.c. |

Supply Gas



PARTS LISTS

This section contains the parts lists for most of the heaters covered in this Service Handbook. Some of the heaters covered here are not yet in production, their parts lists were not available at the time of printing. Always have the model number and the 3 digit "series number" of the heater when locating/ordering parts. Use the correct parts list for that model and series number heater.

You can check part numbers and order parts at **1 800 433-2545** and also at our website <http://www.hotwater.com>

FPSH 75 MODEL 260/261 SERIES & BTF 75 MODEL 104/105 SERIES PARTS UPDATE

The FPSH 75 is the successor of the FPSE 75 heater and it begins with the 260, 261 series numbers, this and the BTF 75 model 104, 105 series heater have added the new Train Blower and have changed burner assemblies. These are the most significant changes and their part numbers are below. Call our parts department at 1 800 433-2545 for other parts numbers on these heaters.

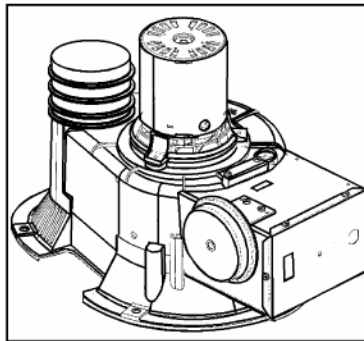

**Train Blower Assembly
AOS Part number 194509**

FPSH 75 model, 260, 261 series and BTF 75 model 104, 105 series:

- AOS Part Number 194209 - 0 Natural Gas Burner Assembly
- AOS Part Number 194209 - 2 Propane Gas Burner Assembly

| Main Burner Orifice Table | | | |
|----------------------------------|---------|--|------------|
| Heater and Series | Gas | | Drill Size |
| FPSH 75 series 260 | Natural | | 20 |
| FPSH 75 series 261 | Propane | | 38 |
| | | | |
| BTF 75 series 104 | Natural | | 20 |
| BTF 75 series 105 | Propane | | 38 |

GENERAL SERVICE INFORMATION

The installation manual, the website <http://www.hotwater.com>, the Technical Information Center at **800-527-1953** by phone or at help@hotwater.com by email all have suggestions and answers concerning the operation and service of water heaters.

Common installation issues:

1. Incorrect polarity – Do not turn these electronic ignition type water heaters on without confirming that supply electricity has correct polarity.
2. Lack of a thermal expansion tank results in a weeping T&P valve.
3. Excessive elbows or equivalent feet of piping on the intake or exhaust vent will cause pressure switches to activate.
4. Exhaust and Intake terminal caps installed where a slight wind can blow exhaust gases to the intake cap results in poor combustion or frosting of screen.
5. Exhaust or intake screens partially blocked, causes an increase in flue gas temperature. May or may not activate pressure switch(s).
6. Heater inner door insulation not properly installed results in poor combustion or wavering flame. Wavering flame may pull away from sensor causing short cycling of main burner.
7. Soot on sensor may reduce flame signal causing lack of ignition or short cycling.
8. Exhaust condensation not properly draining will result in moisture within the blower, the pressure switches or collecting within burner chamber.
9. Ensure that the electrical plug goes to ground. Poor grounding may prevent flame proving during trial for ignition. Do not use water piping for ground.
10. Ground Fault Protection (GFI) breakers/circuits can sometimes cause a short cycling Burner, try plugging the heater into another outlet, however, ensure the outlet you try has correct polarity and grounding.
11. Florescent lighting on the same breaker with the water heater can lead to a short cycling Burner; if this condition is suspected verify there are no other loads on the breaker supplying the water heater. Try plugging the heater into another outlet, however, ensure the outlet you try has correct polarity and grounding.

Common service issues:

1. Inspect the anode rod (top of heater-attached to hex head plug) – especially if water is soft or softened. Replace this protective rod if the core wire in the center of the rod is visible.
2. The Hot Surface Igniter is fragile. Avoid touching the igniter. The use of Propane Gas may require this rod be replaced after several years due to build-up on the surface.
3. GFI circuits, shared circuits, circuits with fluorescent lighting can all cause problems, for most reliable performance the heater should be on a dedicated circuit.
4. On power vented products prior to 260 Series, the fan motor should be oiled once a year, check the owner's manual to see if the motor requires oiling. Series 260 and later model power vented heaters have the Train blower and have sealed bearing motors that do not require oiling.
5. On power vented products using room air for combustion the screen on the air intake opening of the blower assembly should be checked for lint and debris and should be cleaned regularly.

Authors of Handbook: Paul Stewart & Terry Mulder



Visit the “Information Central” link of
www.aosmithwaterheaters.com for a listing
of available Service Handbooks.

Prepared by the Technical Training Department
Ashland City, Tennessee
For additional information contact
A.O. Smith Technical Information Department
at 1-800-527-1953 or visit
www.aosmithwaterheaters.com

©2005 A.O. Smith Corporation

A.O. Smith
Water Heaters