



## PDV Series Power Direct Vent Gas Water Heaters



# SERVICE MANUAL

Troubleshooting Guide  
and Instructions for Service

(To be performed ONLY by  
qualified service providers)

### Models Covered by This Manual:

PDV Series Models:  
RG2PDV40S\*(N,X)  
RG2PDV50S\*(N,X)  
RG2PDV50H\*(N,X)  
RG2PDV75H\*(N,X)  
LG2PDV50H60\*(N,X)  
LG2PDV75H80\*(N,X)  
(\* Denotes Warranty Years)



As required by the state of California Proposition 65.

# The Bradford White PDV Series

## Power Direct Vent Gas Water Heaters

### Table of Contents

	<u>Page</u>	<u>PDV Service Procedure</u>
Introduction .....	4	---
How to Use This Manual .....	5	---
Tools Required for Service .....	5	---
Specifications .....	6	---
Control Timings .....	9	---
Sequence of Operation .....	10	---
Troubleshooting .....	14	---
Burner Inspection, Cleaning & Replacement .....	16	I
Pilot Testing, Cleaning & Replacement .....	17	II
Pressure Switch Testing & Replacement .....	18	III
Blower Testing & Replacement .....	20	IV
Blower Temperature Switch Testing & Replacement .....	22	V
Gas Control Testing & Replacement .....	24	VI
Flammable Vapor Sensor Testing and Replacement .....	28	VII
Safety Circuit Voltage Trace .....	29	VIII
115 VAC Circuit Trace .....	30	IX
Diptube Inspection & Replacement .....	31	X
Anode Inspection & Replacement .....	32	XI
Flue Baffle/Core Inspection & Replacement .....	33	XII
Inner Door Removal, Inspection & Replacement .....	34	XIII
Glossary of Terms .....	37	---
Parts List .....	38	---

# PDV Series

**WARNING:** If the information in these instructions is not followed exactly, a fire or explosion may result causing property damage, personal injury, or death.

## FOR YOUR SAFETY

Do not store or use gasoline or other flammable, combustible, or corrosive vapors and liquids in the vicinity of this or any other appliance.

### WHAT TO DO IF YOU SMELL GAS!

- Do not try to light any appliance.
- Do not touch any electrical switch; do not use any phone in your building.
- Immediately call your gas supplier from a neighbor's phone. Follow the gas supplier's instructions.
- If you cannot reach your gas supplier, call the fire department.

Installation and service must be performed by a qualified installer, service agency or the gas supplier.

## ⚠ DANGER

Do not store or use gasoline or other flammable, combustible, or corrosive vapors and liquids in the vicinity of this or any other appliance.

## IMPORTANT

Before proceeding, please inspect the water heater and its components for possible damage. DO NOT install any water heater with damaged components. If damage is evident then please contact the supplier where the water heater was purchased or the manufacturer listed on the rating plate for replacement parts.

## ⚠ WARNING

Water heaters are heat producing appliances. To avoid damage or injury, do not store materials against the water heater or vent-air intake system. Use proper care to avoid unnecessary contact (especially by children) with the water heater and vent-air intake components. **UNDER NO CIRCUMSTANCES MUST**

**FLAMMABLE MATERIALS, SUCH AS GASOLINE OR PAINT THINNER BE USED OR STORED IN THE VICINITY OF THIS WATER HEATER, VENT-AIR INTAKE SYSTEM OR IN ANY LOCATION FROM WHICH FUMES COULD REACH THE WATER HEATER OR VENT-AIR INTAKE SYSTEM**

## ⚠ CAUTION

If sweat fittings are to be used DO NOT apply heat to the nipples on top of the water heater. Sweat the tubing to the adapter before fitting the adapter to the water connections. It is imperative that heat is not applied to the nipples containing a plastic liner.

## ⚠ WARNING

Hydrogen gas can be produced in an operating water heater that has not had water drawn from the tank for a long period of time (generally two weeks or more). Hydrogen gas is extremely flammable. To prevent the possibility of injury under these conditions, we recommend the hot water faucet to be open for several minutes at the kitchen sink before you use any electrical appliance which is connected to the hot water system. If hydrogen is present, there will be an unusual sound such as air escaping through the pipes as hot water begins to flow. Do not smoke or have open flame near the faucet at the time it is open.

## ⚠ WARNING

DO NOT ATTEMPT TO LIGHT ANY GAS APPLIANCE IF YOU ARE NOT CERTAIN OF THE FOLLOWING:

- Liquefied petroleum gases/propane gas and natural gas have an odorant added by the gas supplier that aids in the detection of the gas.
- Most people recognize this odor as a "sulfur" or "rotten egg" smell.
- Other conditions, such as "odorant fade" can cause the odorant to diminish in intensity, or "fade", and not be as readily detectable.
- If you have a diminished sense of smell, or are in any way unsure of the presence of gas, immediately contact your gas supplier from a neighbor's telephone.

Gas detectors are available. Contact your gas supplier, or plumbing professional, for more information.

## ⚠ WARNING

**FAILURE TO INSTALL AND MAINTAIN A NEW, LISTED 3/4" X 3/4" TEMPERATURE AND PRESSURE RELIEF VALVE WILL RELEASE THE MANUFACTURER FROM ANY CLAIM THAT MIGHT RESULT FROM EXCESSIVE TEMPERATURE AND PRESSURES.**

## ⚠ CAUTION

Turn off or disconnect the electrical power supply to the water heater before servicing. Label all wires prior to disconnection when servicing controls. Wiring errors can cause improper and dangerous operation. Verify proper operation after servicing.

# PDV Series

---

## Introduction

The new Bradford White PDV water heaters are designed to provide reliable performance with enhanced standard features. New design features include reliable spark to pilot ignition system, enhanced diagnostics, simplified servicing, significantly quiet operation, additional vent lengths, and Bradford White Defender Safety System<sup>®</sup> (not available on all models).

Spark to Pilot Ignition System - employing the spark to pilot ignition system promotes reliable and consistent pilot and main burner ignitions to provide hot water on demand.

Integrated Immersion Thermostat/Gas Control Valve with LED - was developed for ease of troubleshooting by providing simple diagnostic codes to pinpoint an installation or component performance issue.

Powerful Blower - will eliminate problems with difficult venting situations.

Quieter and Cooler Blower Operation - blower noise is significantly reduced for both interior and exterior environments. Cooler operation increases blower life by reducing bearing wear and noise.

Rugged Wiring Connections - receptacle type connections promote error free wiring.

Increased Vent Lengths - increased venting performance is achieved while maintaining Energy Factor & FHR (not applicable on all models) performance.

The PDV water heaters use a combustion system where flue gases are combined with dilution air to reduce the flue gas temperature in the blower. The diluted flue gases are evacuated to the exterior through low temperature vent materials. The gas control maintains water temperature, ignition sequence and regulates gas flow. A safety circuit consisting of a pressure switch and blower temperature switch verifies proper conditions exist for safe and reliable operation. If a situation outside of normal operating parameters exists, the gas control diagnostic LED will flash a code to positively identify an operational issue.

This service manual is designed to facilitate problem diagnosis and enhance service efficiency.

Please read the service manual completely before attempting service on this new series of power direct vent models.

## How the Safety System Works

During normal operation, air for combustion is drawn into the water heater through the vent pipe from outside your building. This air travels into the closed combustion chamber. The air then mixes in a normal manner with supplied gas and it's efficiently combusted, producing low NOx emissions.

In the unlikely event trace amounts of flammable vapors are present in the area surrounding the water heater, the sealed combustion system prevents the flammable vapors from reaching the ignition source. In addition the flammable vapors sensor will stop the water heater from operating if a significant amount of flammable vapors are present.

It is intended for this manual to be used by qualified service personnel for the primary purpose of troubleshooting and repair of the Bradford White PDV Series water heaters. Understanding the sequence of operation section of this manual will contribute greatly to troubleshooting the water heater.

The Honeywell WV4462A Electronic Gas Control will display status codes in the event of abnormal operation. Status codes are listed in the troubleshooting chart beginning on page 14 of this service manual. The troubleshooting chart will also indicate the probable cause for the status code and direct the service professional to a service procedure to properly diagnose the abnormal operation.

In some difficult to diagnose conditions, it may be necessary to isolate the heater from the vent system to determine the problem.

Contact the Bradford White technical support group immediately if diagnosis cannot be made using the methods described in this service manual.

## Tools Required for Service

Manometer:	A liquid "U" tube type or a digital (magnahelic) type can be used. This device is used to measure gas and/or air pressure and vacuum.
Multi-Meter:	A digital type is strongly recommended. This device is used to measure electrical values. The meter you select must have the capability to measure volts AC, volts DC, Amps, micro-amps and ohms.
Electronic Probes:	In some cases, standard multi-meter probes will damage or simply not be effective to obtain certain voltage and ohm readings. It will be necessary to have special electronic "pin" type multi-meter probes. These probes are available at most electronic wholesale outlets.
Thermometer:	Used to measure water temperature. An accurate thermometer is recommended.
Water Pressure Gage:	Used to measure water supply pressure. Also used to determine tank pressure by adapting to the drain valve of the heater.
Various Hand Tools:	Pipe wrench, channel locks, open end wrenches (3/8", 7/16", 1/2"), 12" crescent wrench, allen wrench set, screw drivers (common & Phillip's), 1/4" nut driver, pliers (common & needle nose), socket set, side cutters, wire cutters, wire strippers, wire crimpers, torpedo level, small shop vac, step ladder, flashlight and 5 gallon pail.

# PDV Series

## Specifications

Power supply	Dedicated 115 VAC, 60 Hz, 15A.
Gas Supply Pipe	Minimum 1/2" NPT (schedule 40 black iron pipe recommended).
Approved Gas Type	Natural Gas or Propane, unit must match gas type supplied.
Gas Pressure	5.0" W.C. min. for Natural Gas, 11.0" W.C. min. for Propane, 14.0" W.C. maximum (Natural Gas & Propane).
Venting System	Power direct vent through the wall or vertical through the roof.
Approved Vent Materials	PVC, CPVC or ABS.
Minimum Clearance for Servicing	18" from top, 24" from front, 4" sides and rear.
Water Supply Pressure	150 PSI maximum allowable working pressure. Check local codes for supply pressure.
Gas Control ECO Limit	Residential 188°F (87°C), Commercial 199°F (93°C).
Residential Temperature Set Point Range	60°F (16°C) to 160°F (71°C) (approximate temperatures).
Commercial Temperature Set Point Range	80°F (27°C) to 180°F (82°C) (approximate temperatures).
Blower Temperature Switch	Normally closed, opens @ 155°F (68°C), auto reset @ 135°F (57°C).
Pressure Switch	Normally open, closes on vacuum increase @ -.80" W.C.; Opens on vacuum decrease @ -.73" W.C.
Blower	115 VAC, 60 Hz, 3.1 amps, 3000 RPM.

## Vent Tables

Venting Specifications for:

RG2PDV(40,50)S

2" Diameter (5.1 cm) Vent Connector Lengths			
Terminating	# of Elbows	Maximum Straight Length ft. (m)	Minimum Straight Length ft. (m)
Through the Wall	1	30 (9.1)	2 (.6)
Through the Wall	2	25 (7.6)	2 (.6)
Through the Wall	3	20 (6.1)	2 (.6)
Through the Wall	4	15 (4.6)	2 (.6)
Through the Roof	0	35 (10.7)	7 (2.1)
Through the Roof	1	30 (9.1)	7 (2.1)
Through the Roof	2	25 (7.6)	7 (2.1)
Through the Roof	3	20 (6.1)	7 (2.1)

3" Diameter (7.6 cm) Vent Connector Lengths			
Terminating	# of Elbows	Maximum Straight Length ft. (m)	Minimum Straight Length ft. (m)
Through the Wall	1	80 (24.4)	10 (3.1)
Through the Wall	2	75 (22.9)	10 (3.1)
Through the Wall	3	70 (21.3)	10 (3.1)
Through the Wall	4	65 (19.8)	10 (3.1)
Through the Wall	5	60 (18.3)	10 (3.1)
Through the Roof	0	85 (25.9)	15 (4.6)
Through the Roof	1	80 (24.4)	15 (4.6)
Through the Roof	2	75 (22.9)	15 (4.6)
Through the Roof	3	70 (21.3)	15 (4.6)
Through the Roof	4	65 (19.8)	15 (4.6)

# PDV Series

## Specifications

### Venting Specifications for:

RG2PDV(50,75)H  
 LG2PDV(50,75)H

3" Diameter (7.6 cm) Vent Connector Lengths			
Terminating	# of Elbows	Maximum Straight Length ft. (m)	Minimum Straight Length ft. (m)
Through the Wall	1	55 (16.8)	2 (.6)
Through the Wall	2	50 (15.2)	2 (.6)
Through the Wall	3	45 (13.7)	2 (.6)
Through the Wall	4	40 (12.2)	2 (.6)
Through the Roof	0	60 (18.3)	7 (2.1)
Through the Roof	1	55 (16.8)	7 (2.1)
Through the Roof	2	50 (15.2)	7 (2.1)
Through the Roof	3	45 (13.7)	7 (2.1)

4" Diameter (7.6 cm) Vent Connector Lengths			
Terminating	# of Elbows	Maximum Straight Length ft. (m)	Minimum Straight Length ft. (m)
Through the Wall	1	95 (29.0)	10 (3.1)
Through the Wall	2	90 (27.4)	10 (3.1)
Through the Wall	3	85 (25.9)	10 (3.1)
Through the Wall	4	80 (24.4)	10 (3.1)
Through the Wall	5	75 (22.9)	10 (3.1)
Through the Roof	0	100 (30.5)	15 (4.6)
Through the Roof	1	95 (29.0)	15 (4.6)
Through the Roof	2	90 (27.4)	15 (4.6)
Through the Roof	3	85 (25.9)	15 (4.6)
Through the Roof	4	80 (24.4)	15 (4.6)



## Control Timings

<u>Ignition State</u>	<u>Timing</u>
Pre-purge	15 Seconds
Trial for Ignition	90 Seconds
Flame Stabilization Period	3 Seconds
Inter-purge	15 Seconds
Flame Failure Response Time	1.5 Seconds (2 seconds. maximum; 1 second minimum.)
Post-purge	15 Seconds
PS Fault Delay (failed open/close)	Retry after 2 Minutes
Soft Lockout	Retry after 5 Minutes
ECO Limit Lockout	Indefinite (see page 25)
Verify Resistive Delay	Retry after 2 Minutes (repeats 5 times)
Flammable Vapor Sensor/Simulated Resistive Load Lockout	Indefinite (cycle power to restart)
Hardware Status Lockout	Indefinite (self clears if fault clears for at least 15 seconds)

### WIRING DIAGRAM

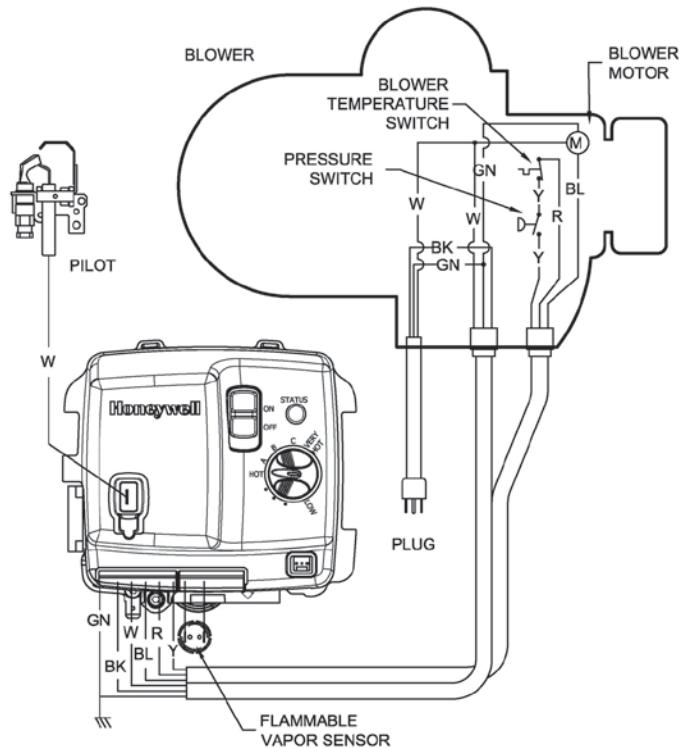

### Power Up Sequence

1. Start Up.  
Upon Power up, the control runs a safe-start check with a typical start-up delay of 1-5 seconds.
2. Flammable Vapor.  
To assure no outputs are energized if the “Flammable Vapor Sensor” is out of range, the control will test the “Flammable Vapor Sensor” or for proper operating range. If the “Flammable Vapor Sensor” is out of range, the control LED immediately flashes 7 times with 3 second pause.

### Normal Heating Sequence

1. Thermostat calls for heat.  
Prior to energizing blower, gas control checks safety circuit to insure the circuit is open. Normal switch positions in the safety circuit are as follows:
  - a) Exhaust pressure switch normally open.
  - b) Blower temperature switch normally closed.

If the safety circuit is closed, the control waits 4 seconds, gas control LED flashes 2 times with 3 second pause. Gas control waits 2 minutes then, blower runs for 30 seconds. This cycle repeats until safety circuit opens.
2. Blower energizes.
3. Blower pre-purge period (15 seconds)
4. Differential pressure switch proves blower/vent system operation.  
If the pressure switch does not close within 30 seconds, the control LED flashes 3 times with 3 second pause. The blower runs for 30 seconds every 2 minutes trying to get the pressure switch or blower temperature switch to close. This cycle repeats as long as there is a call for heat.
5. Trial for pilot ignition (90 seconds).
  - a. The gas control lights the pilot by activating spark igniter and gas flow to pilot burner.
  - b. If flame is not sensed within 90 seconds, igniter and gas flow are deactivated, blower will post purge and control LED flashes 6 times with 3 second pause.
6. Main burner ignition.  
After pilot flame is sensed, gas control activates main valve for main burner ignition. The gas control will ignore flame and pressure switch signals for 3 seconds allowing for main burner to stabilize.

### Normal Heating Sequence (cont.)

#### 7. Steady state operation.

During steady state operation, the control monitors:

**Thermostat temperature sensor**-when set point temperature is satisfied, gas valve is shut down and blower will post purge for 15 seconds. Control LED flashes a short flash once every 4 seconds (idle) status code.

**Pressure switch / blower temperature switch**-if either switch opens, pilot valve and main valve is shut down. The blower continues to run for 30 seconds attempting to close the circuit. The control LED flashes 3 times with 3 second pause.

**Flame sensor**-if flame is lost, pilot & main valve are shut down, blower runs for 15 seconds. Control attempts to re-light pilot 4 times. If unsuccessful, blower is shut down and control proceeds to 5 minute lockout. Control re-attempts to light pilot starting at normal heating sequence #2.

#### 8. Thermostat satisfies. (Control LED flashing once every 4 seconds).

#### 9. Burner off.

#### 10. Blower post purges (15 seconds).

### Abnormal Operation

#### 1. Flammable Vapor Sensor:

- a. **If the resistance is greater than 70,000 Ohms**-the gas control immediately turns off all outputs. Control waits and monitors resistance for 30 seconds. If the resistance is greater than 65,000 ohms after 30 seconds, the gas control proceeds to verify resistive delay for 2 minutes and flashes 7 times then once with a three second pause. This process is repeated 5 times until the control either returns to normal operation or proceeds to flammable vapor lockout.
- b. **If the resistance is below 3000 Ohms**-The gas control immediately turns off all outputs and proceeds to flash 8 times then once with three second pause. The status self clears if the resistance returns to normal range for at least 15 seconds.

#### 2. Temperature Sensor Fault:

- a. **Temperature sensor detected open circuit**-The gas control immediately turns off all outputs and proceeds to flash 8 times then, 3 times with 3 second pause. The status self clears if the fault clears for at least 15 seconds.
- b. **Thermal well sensor not reading the same temperature within  $\pm 5.5^{\circ}\text{F}$**  – The gas control immediately turns off all outputs and proceeds to flash 8

### Abnormal Operation (cont.)

times, then 3 times twice with 3 second pause. The status self clears if the fault clears for at least 15 seconds.

- c. **Water temperature in excess of ECO (energy cut out) limit** -The gas control immediately turns off pilot & main valves and proceeds to flash 4 times with 3 second pause. Blower continues to run until gas control is reset. To reset control, rotate knob of temperature control to the minimum setting for at least 6 seconds before returning to desired temperature setting.
3. Pressure Switch/Blower Temperature Fault:
    - a. **Pressure switch closed at start of call for heat**-the gas control waits 4 seconds then, proceeds to flash 2 times with 3 second pause. The control waits 2 minutes and then turns on blower for 30 seconds. The blower turns off after 30 seconds and the control waits for pressure switch to open. Any time the pressure switch opens, the blower turns on (or stays on) and the control proceeds to wait for pressure switch to close.
    - b. **Pressure switch or blower temperature switch failed to close**-the gas control runs the blower for 30 seconds waiting for the pressure switch and/or blower temperature switch to close. If either switch does not close in 30 seconds, the blower turns off and the control flashes 3 times with 3 second pause. The gas control waits 2 minutes before turning on the blower for another 30 seconds to see the circuit close. This cycle repeats as long as there is a call for heat or until the circuit closes.
    - c. **Pressure switch or blower temperature switch opens during burner operation**-the gas control turns off the pilot and main valve, runs blower for 15 seconds (inter-purge) waiting for pressure switch and/or blower temperature switch to close. If either switch fails to close, the control proceeds as described in 3b above, if the circuit closes again by the end of the inter-purge, the recycle counter is incremented, if the recycle count as not reached its limit (4), another trial for ignition begins. If the recycle count has been reached, the gas control turns off the blower and flashes 6 times then, 2 times with 3 second pause. The gas control waits 5 minutes before repeating ignition sequence.
  4. Trail for Ignition Fault:
    - a. **Pressure switch opens during trial**-the gas control turns off igniter and pilot valve. The gas control proceeds as described in 3b above. If the pressure switch closes within 30 seconds the gas control will continue with trial for ignition starting at blower pre-purge.
    - b. **Flame not sensed**-the gas control energizes the spark igniter attempting to light the pilot and prove flame. If flame is not sensed within 90 seconds, the igniter turns off, the pilot valve is closed and the gas control runs the blower through post purge and flashes 6 times then, once with 3 second pause. The control waits 5 minutes before repeating the ignition sequence.

## Abnormal Operation (cont.)

5. Flame sensing fault:

- a. **Flame lost during run**-the gas control turns off pilot and main valves, runs blower for 15 seconds (inter-purge). The gas control increments the recycle count, if the recycle count has not reached its limit (4), another trial for ignition begins. If the recycle count has been reached, the gas control turns off the blower and flashes 6 times then, 3 times with 3 second pause. The gas control waits 5 minutes before repeating the ignition sequence.
- b. **Flame sensed out of sequence**-the gas control only looks for pilot flame when the blower is running. If flame is present when the pilot valve is not open, the gas control proceeds to wait for flame loss and flashes 5 times with 3 second pause. This continues until flame is lost. Once the flame signal is lost, the control flashes 6 times then, 4 times with 3 second pause. The control waits 5 minutes before repeating the ignition sequence.

# PDV Series

## Troubleshooting

Observe green LED indicator on Electronic gas control. Status flash codes are displayed with a three second pause before repeating. Check and repair the system as noted in the troubleshooting table below

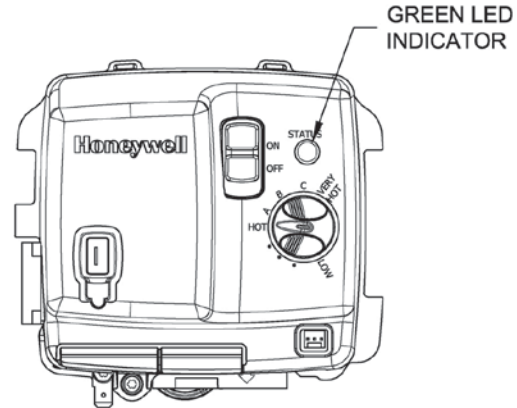

<u>LED Status</u>	<u>Control Status</u>	<u>Probable Cause</u>	<u>Service Procedure</u>
None, control LED not on or flashing	No electrical power	Control power switch in "OFF" position. Supply voltage interrupted.	Turn power on
Short flash, once every four seconds	Stand-by mode, Waiting for call for heat (no fault).	Temperature demand is satisfied.	Normal operation. Adjust thermostat to temp level
"Heartbeat", alternates bright/dim	Thermostat calling for heat (no fault).	Tank temperature below set point of thermostat.	Normal operation. Adjust thermostat to temp level
Short flash once per second	Weak pilot signal on last call for heat.	<ol style="list-style-type: none"> <li>1. Unstable pilot.</li> <li>2. Pilot tube block or restricted.</li> <li>3. Oxidation builds up on pilot electrode.</li> <li>4. Wire damage to pilot assembly or bad connection at gas valve.</li> </ol>	Page 17
Two flash, three second pause	Pressure switch not working-closed position.	<ol style="list-style-type: none"> <li>1. Pressure switch tubing kinked or blocked.</li> <li>2. Blocked pressure tap on switch or blower.</li> <li>3. Faulty pressure switch.</li> </ol>	Page 18
Three flash, three second pause	Pressure switch or blower temp. switch not working -open position.	<ol style="list-style-type: none"> <li>1. Vent blockage or improper vent configuration.</li> <li>2. Pressure switch tubing kinked or blocked.</li> <li>3. Faulty pressure switch.</li> <li>4. Blower not spinning up to speed.</li> <li>5. Blower temp or exhaust temp too high.</li> <li>6. Faulty blower temperature switch.</li> </ol>	<ol style="list-style-type: none"> <li>1. Check vent or vent tables.</li> <li>2 &amp; 3 Page 18</li> <li>4. Page 20</li> <li>5 &amp; 6 Page 22</li> </ol>
Four flash, three second pause	Excessive tank temperature. System must be reset.	<ol style="list-style-type: none"> <li>1. Temperature sensor out of calibration.</li> <li>2. Faulty gas control.</li> <li>3. Plumbing leak.</li> </ol>	1 & 2. Replace gas control, page 26
Five flash, three second pause	Undesired-false pilot flame present.	<ol style="list-style-type: none"> <li>1. Pilot valve stuck in open position.</li> </ol>	Replace gas control, page 26

# PDV Series

## Troubleshooting

<u>LED Status</u>	<u>Control Status</u>	<u>Probable Cause</u>	<u>Service Procedure</u>
Six-one flash, three second pause	Failed to light pilot. System auto resets.	<ol style="list-style-type: none"> <li>1. Unstable pilot.</li> <li>2. Pilot tube blocked or restricted.</li> <li>3. Oxidation build up on pilot electrode.</li> <li>4. Wire damage to pilot assembly or bad connection at gas valve.</li> </ol>	Page 17
Six-two flash, three second pause	Pressure switch or blower temp switch opened during burner operation. System auto resets.	<ol style="list-style-type: none"> <li>1. Vent blockage or improper vent configuration.</li> <li>2. Pressure switch tubing kinked or blocked.</li> <li>3. Faulty pressure switch.</li> <li>4. Vent termination being affected by wind.</li> <li>5. Blower not spinning up to speed.</li> <li>6. Blower temp or exhaust temp too high.</li> <li>7. Faulty blower temperature switch.</li> </ol>	<ol style="list-style-type: none"> <li>1. Check vent or vent tables.</li> <li>2 &amp; 3 Page 18</li> <li>4. Refer to venting section of installation manual</li> <li>5. Page 20</li> <li>6 &amp; 7 Page 22</li> </ol>
Six-three flash, three second pause	Pilot flame extinguished. System auto resets.	<ol style="list-style-type: none"> <li>1. Unstable pilot.</li> <li>2. Pilot tube blocked or restricted.</li> <li>3. Oxidation build up on pilot electrode.</li> <li>4. Wire damage to pilot assembly or bad connection at gas valve.</li> <li>5. Insufficient combustion air.</li> <li>6. Gas pressure is out of specification..</li> </ol>	<ol style="list-style-type: none"> <li>1-4. Page 17</li> <li>5. Refer to installation manual</li> <li>6. Page 24</li> </ol>
Six-four flash, three second pause	Undesired-false pilot flame sensed. System auto resets.	Pilot valve stuck in open position.	Replace gas control, page 26
Seven flash, three second pause	Flammable vapor sensor fault detected.	Flammable vapor sensor or simulative resistance device out of specification.	Page 28
Eight-one flash, three second pause	Flammable vapor sensor out of specification.	Flammable vapor sensor or Simulated resistive device out of specification.	Page 28
Eight-two flash, three second pause	Temperature Sensor fault.	<ol style="list-style-type: none"> <li>1. Damage to temperature sensor wire.</li> <li>2. Temperature sensor resistance out of range.</li> </ol>	Replace gas control, page 26.
Eight-three flash, three second pause	Gas valve electronics fault detected.	<ol style="list-style-type: none"> <li>1. Control needs to be reset.</li> <li>2. Control is wet or physically damaged.</li> </ol>	<ol style="list-style-type: none"> <li>1. Interrupt power supply</li> <li>2. Replace gas control, page 26</li> </ol>
Eight-four flash, three second pause	Gas valve fault detected.	<ol style="list-style-type: none"> <li>1. Control needs to be reset.</li> <li>2. Control is wet or physically damaged.</li> </ol>	<ol style="list-style-type: none"> <li>1. Interrupt power supply</li> <li>2. Replace gas control, page 26</li> </ol>



# PDV Series

## PDV SERVICE PROCEDURE I Burner Operation Inspection, Cleaning and Replacement

### Burner Inspection

At periodic intervals (every 6 months) a visual inspection should be made of the pilot and main burner for proper operation and to assure no debris is accumulating.

Pilot flame should be stable, some causes for an unstable pilot flame are:

- a) Water heater vent is less than the allowable vent length.
- b) Gas pressure is out of specification.
- c) Pilot flame not fully engulfing spark/flame sensor.

Main burner should light smoothly from pilot and burn with a blue flame with a minimum of yellow tips.

Main burner must be free from any debris accumulation that may affect burner operation (see burner cleaning procedure on page 16).

### Burner Cleaning

- Step 1. Position gas control power switch to the "OFF" position and unplug heater from wall outlet.
- Step 2. Turn off gas supply to water heater.
- Step 3. Remove outer jacket door and inner door per service procedure XIII on page 34.
- Step 4. Disconnect pilot tube (7/16" wrench) and feedline (3/4" wrench) from gas control.
- Step 5. Disconnect igniter/flame sensor wire from gas control.
- Step 6. Remove burner assembly from combustion chamber.
- Step 7. Thoroughly inspect burner surface area and burner port area and remove any loose debris.
- Step 8. Unscrew burner from main burner orifice.
- Step 9. Remove main burner orifice from feedline (1/2" wrench on steel burners) inspect orifice, clean or replace if necessary.
- Step 10. Reassemble burner and reinstall into water heater. Restore gas supply and check for gas leaks.
- Step 11. To resume operation, follow the instruction located on the lighting instruction label or the lighting instruction located in the installation and operation manual.

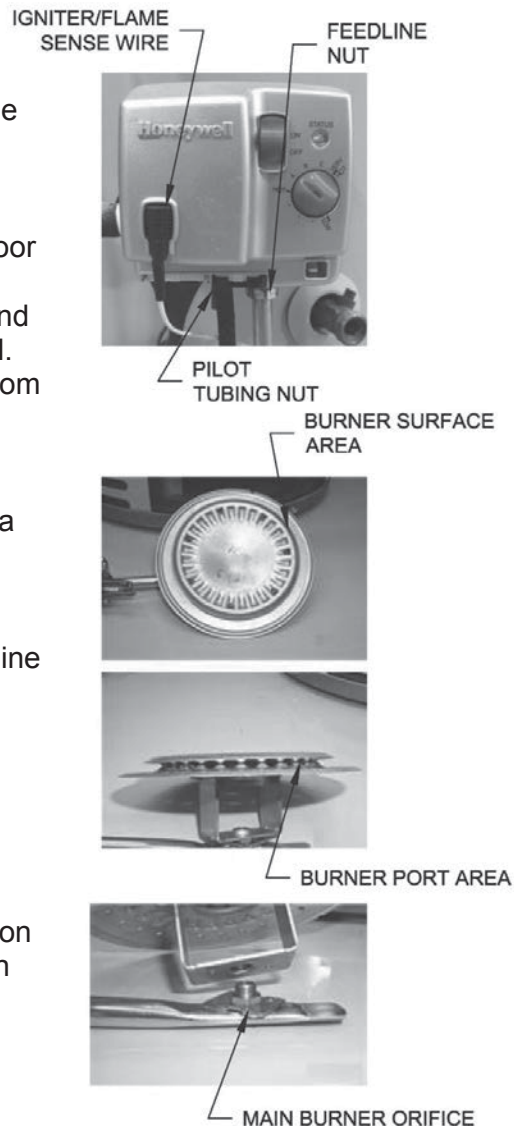



### Pilot Testing and Replacement

- Step 1. Position gas control power switch to the "OFF" position and unplug heater from wall outlet.
- Step 2. Turn off gas supply to water heater.
- Step 3. Remove outer jacket door and inner door per service procedure XIII on page 34.
- Step 4. Disconnect pilot tubing nut (7/16" wrench) and feedline nut (3/4" wrench) from gas control.
- Step 5. Disconnect igniter/flame sense wire from gas control.
- Step 6. Remove burner assembly from combustion chamber.
- Step 7. Remove pilot assembly from feedline (1/4" nut driver).
- Step 8. Visually inspect igniter/flame sense wire for damage. Replace pilot if damage is found.
- Step 9. With a multi-meter set to ohms setting, check continuity through igniter/flame sense wire. Replace pilot if no continuity.
- Step 10. Visually inspect igniter/flame sense electrode for deterioration. Replace pilot as necessary. Electrode should not be in contact with pilot hood, if so, carefully adjust electrode to a gap of distance of 3/32" (.09) from pilot hood.
- Step 11. Visually inspect igniter/flame sense electrode for oxidation build up. Carefully clean any oxidation using very fine emery cloth.
- Step 12. Visually inspect pilot tubing for kinks or cracks. If damage is found, replace pilot.
- Step 13. Inspect pilot tubing and pilot orifice for blockage:
  - a. Remove ferrule nut from bottom of pilot assembly (7/16" wrench).
  - b. Remove pilot tube and pilot orifice.
  - c. Inspect pilot tubing and pilot orifice for blockage. Clean or replace as necessary.
- Step 14. Reassemble pilot and install on feedline. Reinstall burner assembly to water heater. Restore gas supply and check for gas leaks.
- Step 15. To resume operation, follow the instruction located on the lighting instruction label or the lighting instruction located in the installation and operation manual.

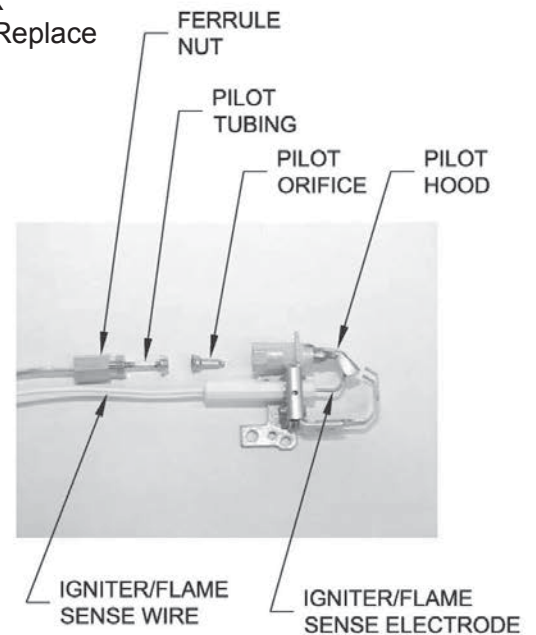

# PDV Series

## PDV SERVICE PROCEDURE III Pressure Switch Testing and Replacement

### Pressure Switch Testing

- Step 1. Position power switch on gas control to the "OFF" position.
- Step 2. Remove the three screws (Phillips screw driver) from control access cover on blower assembly and remove cover (see photo 1).
- Step 3. Carefully remove pressure switch from blower housing (see photo 2).

#### ⚠ WARNING

**115 volt potential exposure. Use caution to avoid personal injury.**

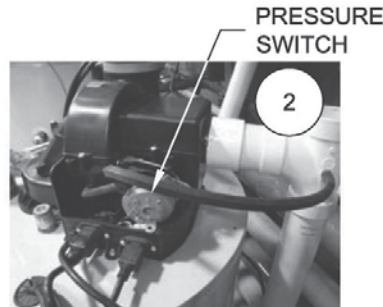
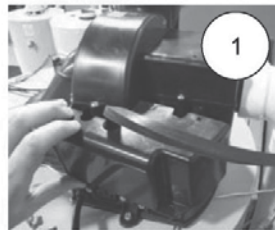

With steps 1,2 & 3 complete, disconnect wire leads from pressure switch.

Slide pressure switch in direction of arrow while tilting slightly away from blower housing.

PRESSURE SWITCH WIRE LEADS

PRESSURE SWITCH

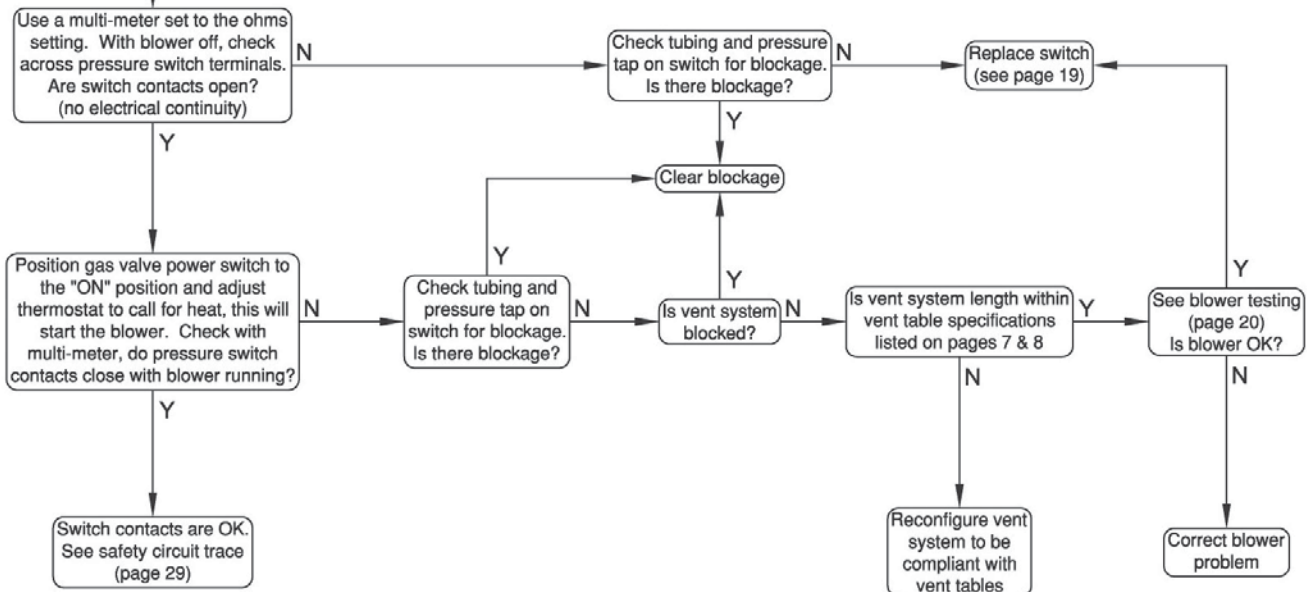

# PDV Series

## PDV SERVICE PROCEDURE III Pressure Switch Testing and Replacement

### Pressure Switch Replacement

- Step 1. Position gas control power switch to "OFF" position.
- Step 2. Remove the three screws (Phillip's screw driver) from control access cover on blower assembly and remove cover (see photo 3).
- Step 3. Carefully remove pressure switch from blower housing (see photo 4).
- Step 4. Disconnect tubing from pressure switch. (see photo 5).
- Step 5. Disconnect yellow wires from pressure switch (see photo 6).
- Step 6. Reconnect wires from step 6 to new pressure switch.
- Step 7. Reconnect tubing to new pressure switch.
- Step 8. Carefully position pressure switch into blower housing.
- Step 9. Position gas control power switch to "ON" position and verify proper heater operation.
- Step 10. Replace control access cover from step 2.

#### **⚠ WARNING**

**115 volt potential exposure. Use caution to avoid personal injury.**

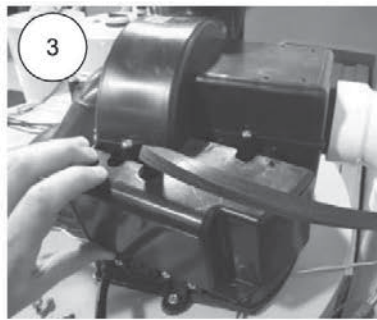

Slide pressure switch in direction of arrow while tilting slightly away from blower housing.

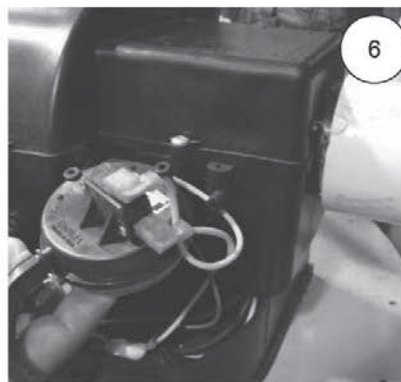

# PDV Series

## PDV SERVICE PROCEDURE IV Blower Testing and Replacement

### Blower Testing

- Step 1. Position gas control power switch to "ON" position and adjust control to call for heat.
- Step 2. Remove the three screws (Phillip's screw driver) from control access cover on blower assembly and remove cover (see photo 7).

#### ⚠ WARNING

115 volt potential exposure. Use caution to avoid personal injury.

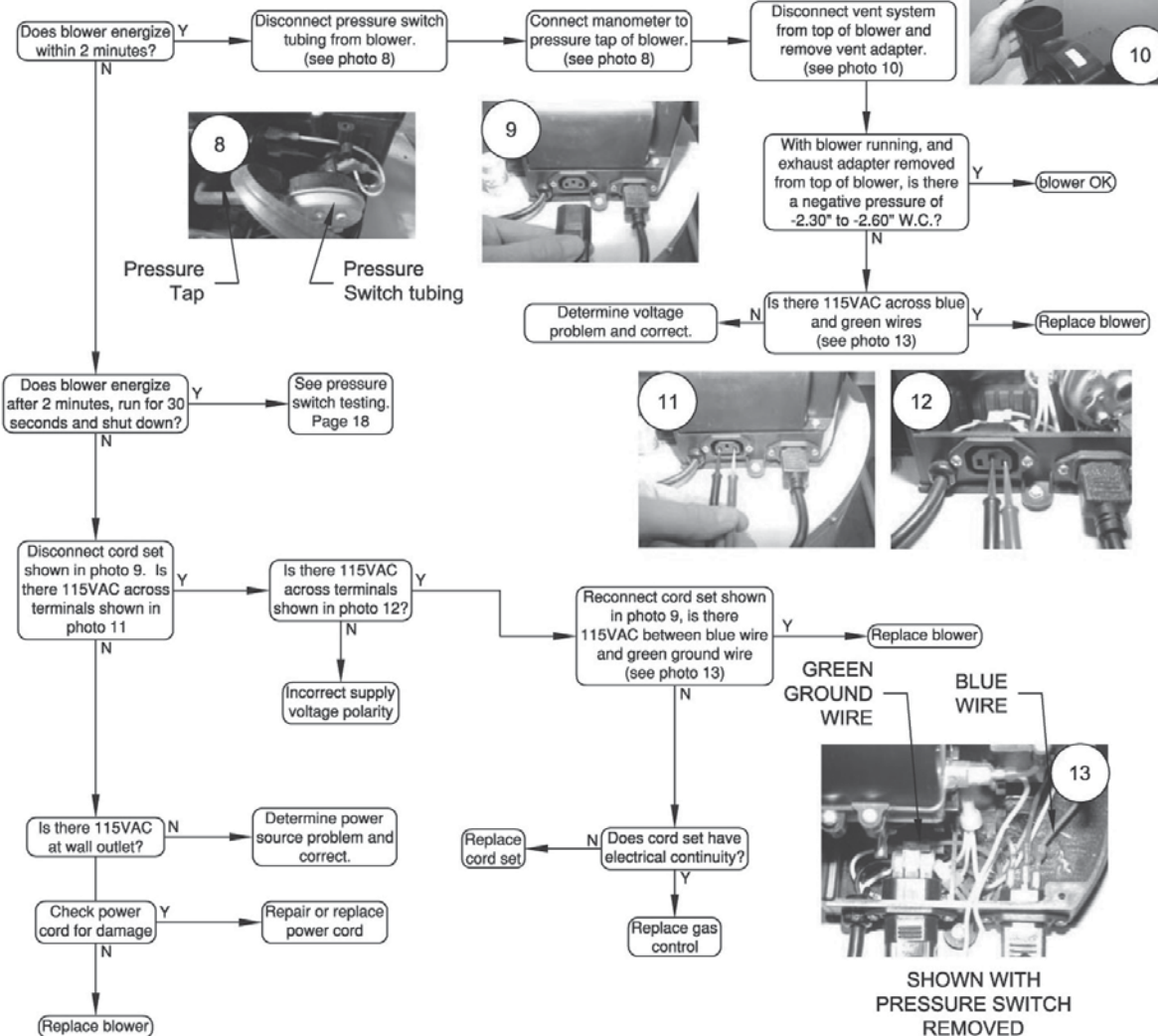
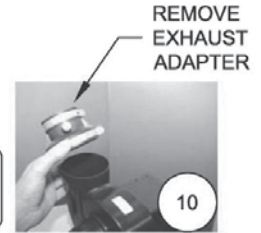
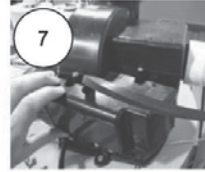



# PDV Series

## PDV SERVICE PROCEDURE IV Blower testing & Replacement

### Blower Removal

- Step 1. Position gas control power switch to "OFF" position and adjust control to call for heat.
- Step 2. Unplug blower power cord from wall outlet.
- Step 3. Disconnect vent system from exhaust adapter on top of blower.
- Step 4. Remove exhaust adapter from blower (blade screw driver) and retain for use on new blower.
- Step 5. Unplug cord sets from blower.
- Step 6. Remove vertical air intake bracket.
- Step 7. Disconnect vertical air intake from blower.
- Step 8. Remove the three blower mounting screws (1/4" nut driver).
- Step 9. Remove blower with gasket from water heater.

REMOVE EXHAUST  
ADAPTER AND RETAIN  
FOR USE ON NEW  
BLOWER

BLOWER  
MOUNTING  
SCREWS

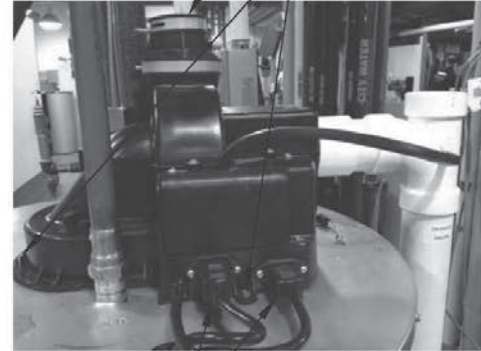

BLOWER CORD SETS

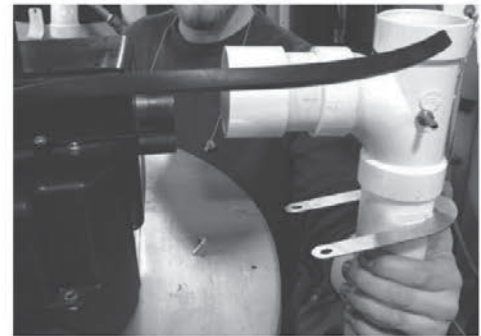

### Blower Installation

- Step 10. Clean any debris from jacket head of water heater.
- Step 11. Set new blower with gasket in place using locating pins on blower flange to line up with location holes in jacket head. Be sure not to damage gasket.
- Step 12. Secure blower in place using mounting screws from step 8.
- Step 13. Re-install exhaust adapter from step 4.
- Step 14. Reconnect vent system to exhaust adapter.
- Step 15. Reconnect cord sets from step 5.
- Step 16. Plug blower power cord into wall outlet.
- Step 17. Position gas control power switch to the "ON" position.
- Step 18. Verify proper blower operation.

LOCATING PINS  
ON BLOWER  
FLANGE

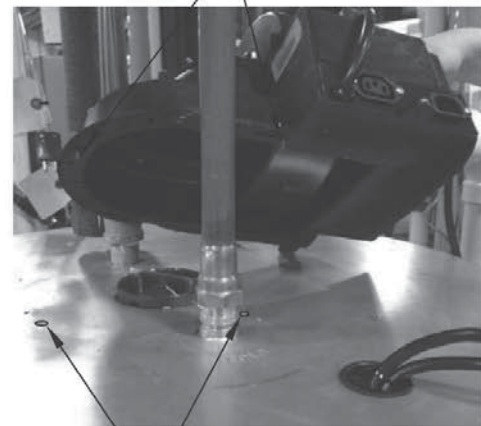

PIN LOCATION HOLES  
IN JACKET HEAD

# PDV Series

## PDV SERVICE PROCEDURE V Blower Temperature Switch Testing and Replacement

### Blower Temperature Switch Testing

Position the power switch on the gas control to the "OFF" position.

- Step 1. Remove the three screws (Phillip's screw driver) from control access cover on blower and remove cover (see photo 14).
- Step 2. Locate blower temperature switch (see photo 15).

**⚠ WARNING**  
115 volt potential exposure. Use caution to avoid personal injury.

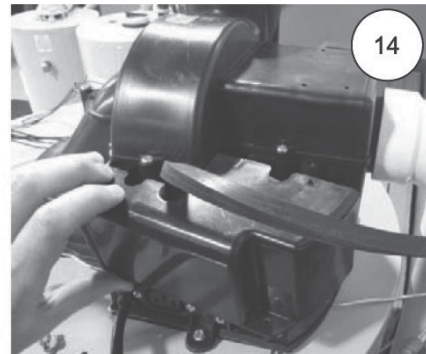

**Switch Setting**  
Opens on rise @ approximately 155°F  
Auto resets on fall @ approximately 130°F

Cool switch to below 130°F

BLOWER TEMPERATURE SWITCH LOCATION

Disconnect wire leads to switch. Using a multi-meter set to the ohms setting, is there continuity between the switch terminals?

Replace switch (see page 23)

Reconnect wire leads and observe heater operation. Do exhaust gas temperatures rise to or above 170°F with vent connected?

Do switch contacts open?

Exhaust temperature is too hot.

**Common causes for high exhaust temperatures**

1. Vent length is below minimum allowable.
2. Vent diameter not to specification.
3. Restricted dilution air inlet.
4. Missing or deteriorated flue baffle.
5. Gas pressure is out of specification.

Do switch contacts open?

Replace switch (see page 23)

Switch OK

# PDV Series

## PDV SERVICE PROCEDURE V Blower Temperature Switch Testing & Replacement

### Blower Temperature Switch Replacement

#### ⚠ WARNING

115 volt potential exposure. Use  
caution to avoid personal injury.

- Step 1. Position gas control power switch to the "OFF" position and unplug heater from wall outlet.
- Step 2. Remove the three screws (Phillip's screw driver) from the control access cover on blower and remove cover (see photo 16).
- Step 3. Locate blower temperature switch (see photo 17).
- Step 4. Disconnect red and yellow wire leads from switch.
- Step 5. With an appropriate tool such as side cutters, snip the retaining lug from the blower housing to allow removal of temperature switch (see photo 18).
- Step 6. Remove switch from blower housing.
- Step 7. Install new switch. Be sure switch is properly seated in mounting area.
- Step 8. Reconnect red and yellow wires to new switch. Wires are interchangeable with either terminal.
- Step 9. Position gas control power switch to the "ON" position and verify proper heater operation.
- Step 10. Replace control access cover from step 2.

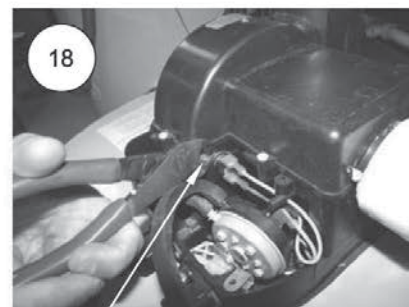
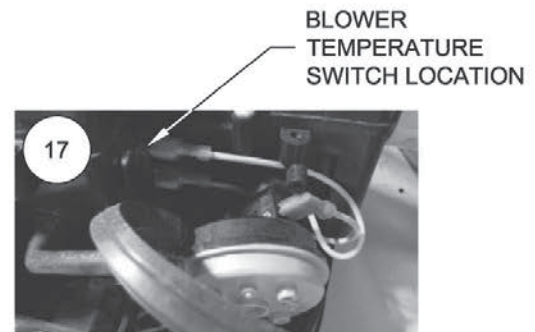
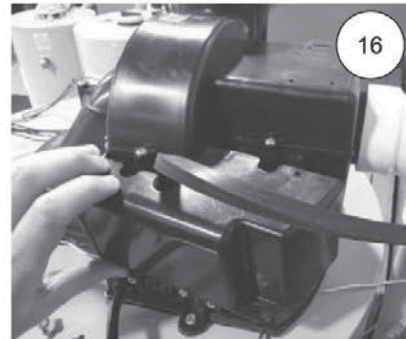

SNIP RETAINING LUG  
FROM BLOWER  
HOUSING

## Honeywell Gas Control Testing & Replacement

### Line Pressure

The Gas Control is designed for a maximum line pressure of 14.0" W.C. and a minimum line pressure of 1.0" W.C. over the water heater's rated manifold pressure (check rating plate). Line pressure must be checked with the main burner on and off to assure proper readings.

### Manifold Pressure Testing

(This procedure presumes a maximum line pressure of 14.0" W.C.)

- Step 1. Set the Gas Control to the "OFF" position.
- Step 2. Remove pressure tap plug and install 1/8" NPT pipe, coupling & pressure tap.
- Step 3. Connect manometer to pressure tap.
- Step 4. Follow instructions located on the lighting instructions label and proceed to light the main burner and observe manometer reading.
- Step 5. Proper operating range for Natural Gas is 4.0"  $\pm$ 0.5" W.C. Proper operating range for Propane gas is: 10.0"  $\pm$ 0.5" W.C.
- Step 6. If pressure is within the range specified in the previous step, set Gas Control knob to the "OFF" position, remove manometer and pressure tap, and replace pressure tap plug. Check for gas leaks prior to placing water heater back into operation by following the instructions located on the lighting label or the lighting instructions located in the installation and operation manual.
- Step 7. If gas pressure is outside the specification noted above, refer to "Honeywell Gas Control Testing, Disassembly and Replacement" to replace gas control or valve body.

GAS CONTROL  
SHOWN IN THE  
"OFF" POSITION



3/16"  
ALLEN  
WRENCH



PRESSURE TAP  
SHOWN INSTALLED



## ECO (Energy Cut Out) Reset

The Honeywell Gas Control is designed with an ECO device that will reset.

To reset the Gas Control after a status code (4), turn the Gas Control knob to the “OFF” position and wait a minimum of (5) minutes before relighting following the instructions located on the lighting instruction label or the lighting instructions located in the installation and operation manual.

## Determine Water Temperature Inside Tank

### **▲ WARNING**

Stored water may be HOT WHEN PERFORMING THE FOLLOWING STEPS IN THIS PROCEDURE. Take necessary precaution to prevent personal injury.

- Step 1. Position gas control power switch to “OFF” position.
- Step 2. Draw approximately 4 gallons of water from drain valve into a container and discard. Draw an additional gallon and immediately measure water temperature using an accurate thermometer. It may be necessary to open a hot water faucet to allow heater to drain.
- Step 3. Compare the measured water temperature with the setting on the gas control. In most instances, they should not differ by more than approx. 10°F.

### Gas Control Removal From Water Heater

- Step 1. Position gas valve power switch to the "OFF" position and unplug heater from power supply.
- Step 2. Drain heater to a point below the gas control level.
- Step 3. Turn off gas supply to water heater and disconnect gas piping from gas control.
- Step 4. Disconnect wire harnesses from gas control.
- Step 5. Remove outer jacket burner access door.
- Step 6. Right side inner door removal.
  - a. Remove (2) hex drive screws from RIGHT side inner door.
  - b. Remove (2) hex drive screws from FLANGE SECTION of inner door.
  - c. Remove right side inner door and set aside. Be careful not to damage gasket material in inner door.
- Step 7. Removal of Gas Control
  - a. Disconnect main burner feedline and pilot tube.
  - b. Remove Gas Control from water heater by rotating counter clockwise. DO NOT use a wrench on the Gas Control body, damage to the Gas Control may occur. If necessary, use a length of 1/2" NPT pipe threaded into gas inlet of Gas Control.

GAS CONTROL  
SHOWN IN THE  
"OFF" POSITION



1/4" HEX DRIVE SCREWS  
RIGHT AND LEFT SIDE  
INNER DOOR.

1/4" HEX DRIVE SCREWS  
AT FLANGE AREA OF  
INNER DOOR

- Step 8. Install new Gas Control into water heater.
  - a. Install new Gas Control into water heater by rotating clockwise. DO NOT use a wrench on the Gas Control body, damage to the Gas Control may occur. If necessary, use a length of 1/2" NPT pipe threaded into gas inlet of Gas Control.
  - b. Reattach main burner feedline, pilot tube and thermopile wire.
  - c. Reconnect gas supply piping to inlet of Gas Control.

## Reinstallation of Inner Door Assembly.

d. Prior to reinstallation of inner door, fully inspect for the following:

- Tears
- Other imperfections that will inhibit proper seal
- Missing Material
- Gasket adhesion to inner door
- Cracks
- Material left on combustion chamber (around opening)
- Dirt or debris

If the gasket is not affected by any of the above, gasket replacement will not be required. If replacement is required, replace using new gasket kit following the instructions provided with kit.

- e. Clean any gasket residue or other debris from combustion chamber surface before installing the inner door/gasket assembly.
- f. Position thermopile wire and pilot tube against left side inner door flange gasket. **DO NOT ROUTE THROUGH RADIUSED CHANNEL WITH FEEDLINE.** Be sure that thermopile and pilot tube are not in position to interfere with outer jacket burner access door when reinstalled.
- g. Firmly place right side inner door flange against the left side inner door flange and secure with (2) hex drive screws from step 6c. **DO NOT OVER TIGHTEN SCREWS.**
- h. Align right side inner door to combustion chamber and verify the fastener holes of the combustion chamber are aligned with the right side inner door slotted openings. Verify seal integrity around combustion chamber opening. Secure right side inner door using (2) hex drive screws from step 6b. **DO NOT OVER TIGHTEN SCREWS.** Verify both left and right sides of the inner door are properly positioned and sealed against the combustion chamber.

### **⚠ CAUTION**

A seal breach may result in a fire or explosion causing property damage, personal injury or death.

- Step 9. Replace outer jacket burner access door.
- Step 10. Reconnect gas supply to Gas Control.
- Step 11. Resume water supply to water heater.  
Be sure tank is full of water before resuming operation.
- Step 12. To resume operation follow the instructions located on the lighting instruction label or the lighting instructions located in the installation and operation manual.

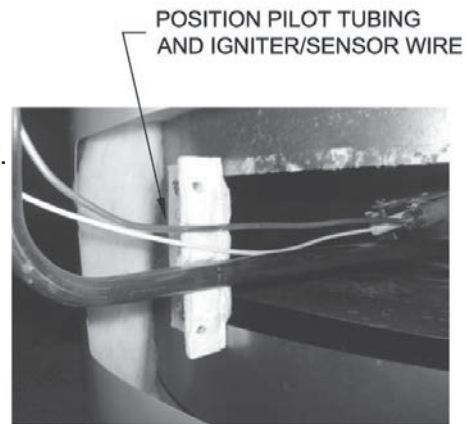

# PDV Series

## PDV SERVICE PROCEDURE VII Flammable Vapor/Simulative Resistance Device Testing

### Flammable Vapor Sensor Testing

- Step 1. Position power switch on gas control to the "OFF" position.
- Step 2. Disconnect flammable vapor sensor from gas control.
- Step 3. Using a multi-meter set to the ohms setting, check resistance of flammable vapor sensor. Resistance must be within 3,000 ohms and 48,000 ohms. If outside of this range replace Flammable Vapor Sensor.

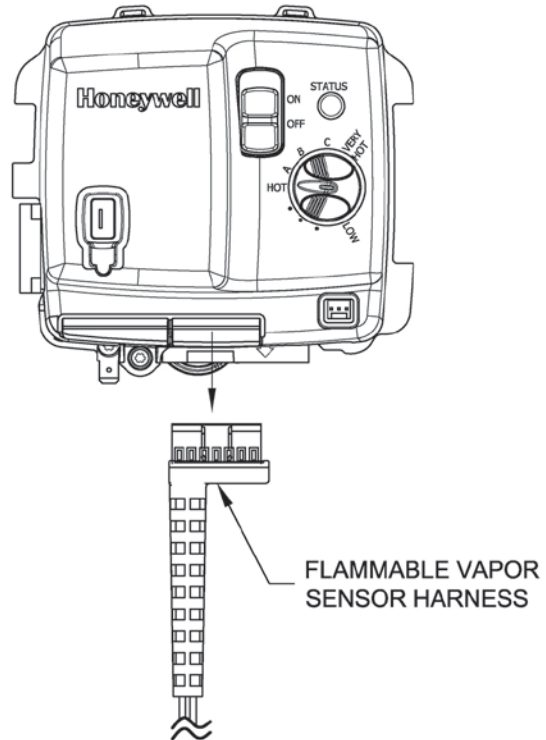

#### **CAUTION**

**DO NOT** use a standard multi-meter probe for this test. Doing so will damage connector. Use special pin type electronic probes or small diameter wire pins inserted into connector.

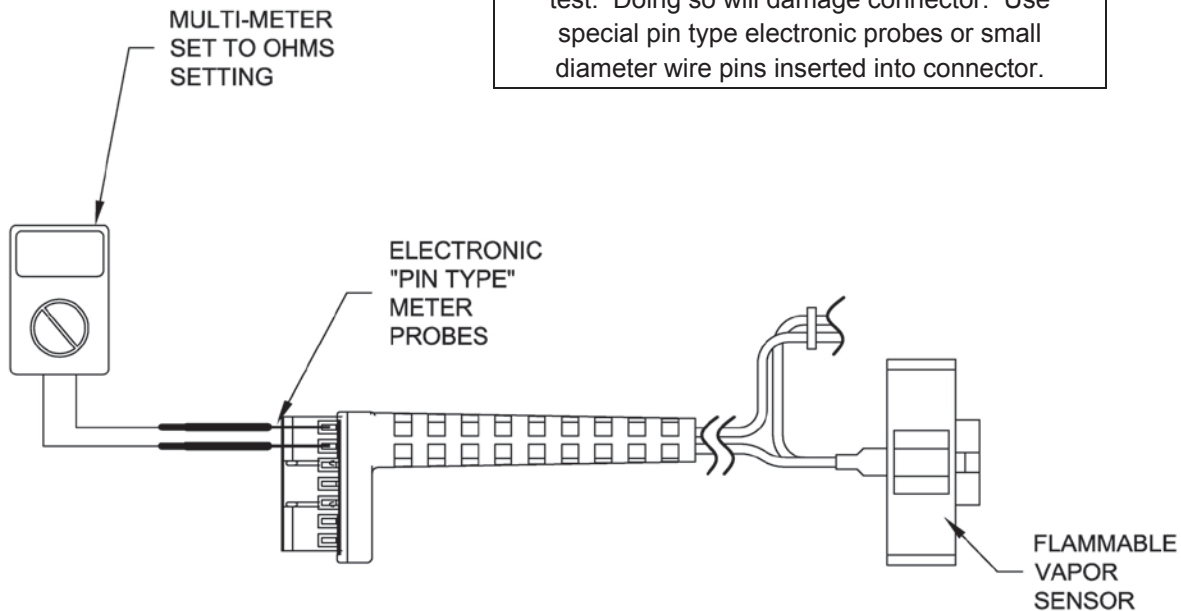

# PDV Series

## PDV SERVICE PROCEDURE VIII Safety Circuit Voltage Trace

### Safety Circuit Voltage Trace

NOTE: This procedure assumes a cool tank.

Remove Three screws (Phillips Screw driver) from control access cover on blower and remove cover (see photo 21).

**⚠ WARNING**  
115 volt potential exposure. Use caution to avoid personal injury.

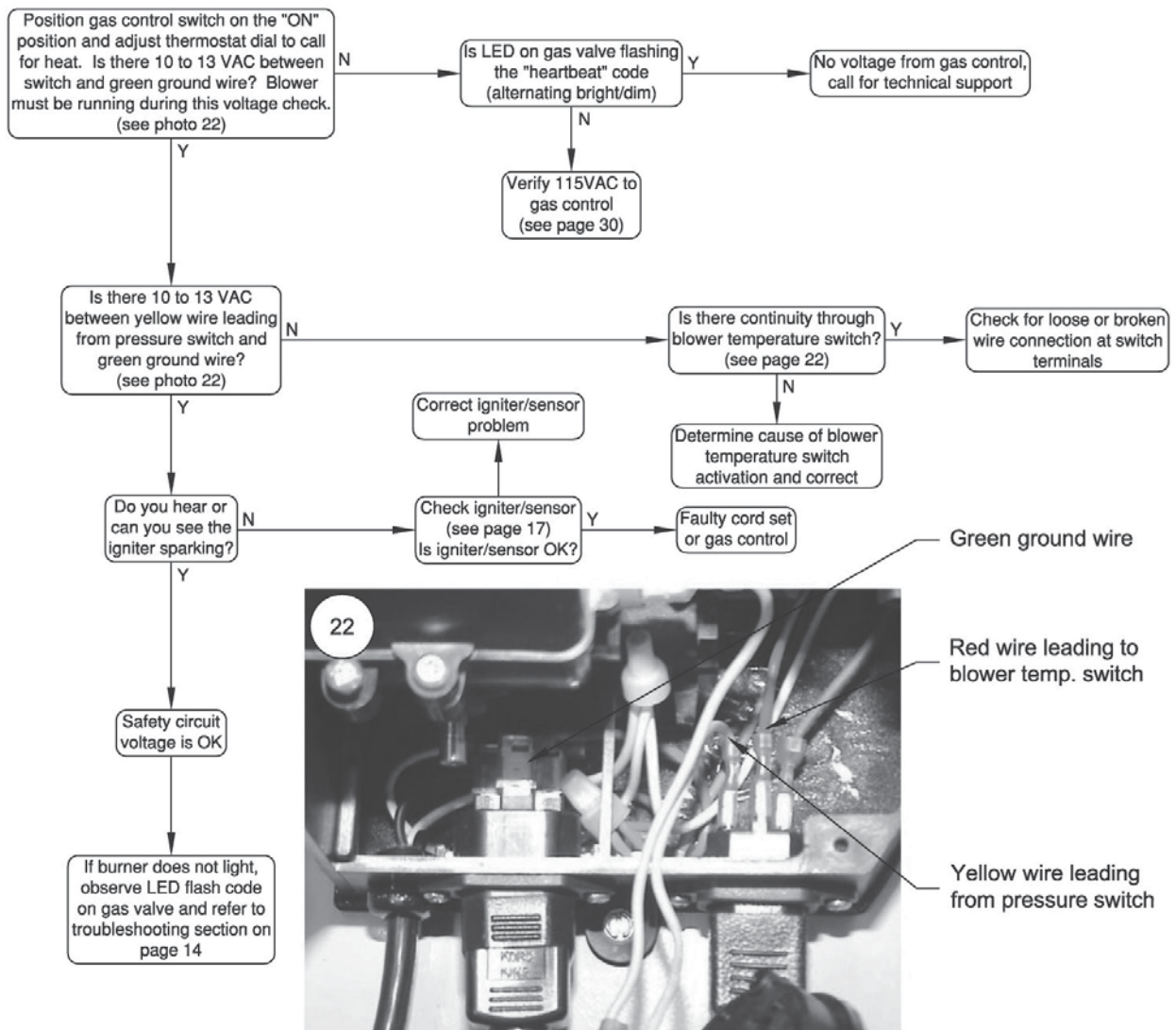
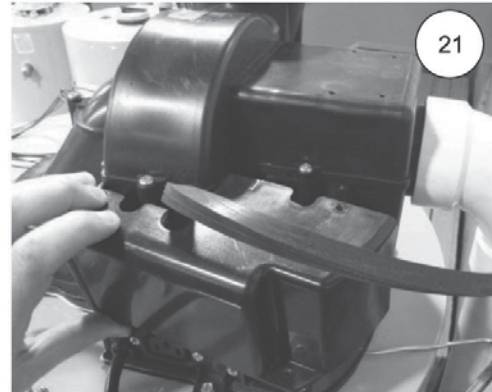



# PDV Series

## PDV SERVICE PROCEDURE IX 115VAC Circuit Trace

### 115 VAC Circuit Trace

- Step 1. Verify 115 VAC and proper polarity at wall outlet.
- Step 2. With unit plugged in and control power switch in the "ON" position verify LED status.

**⚠ WARNING**  
115 volt potential exposure. Use caution to avoid personal injury.

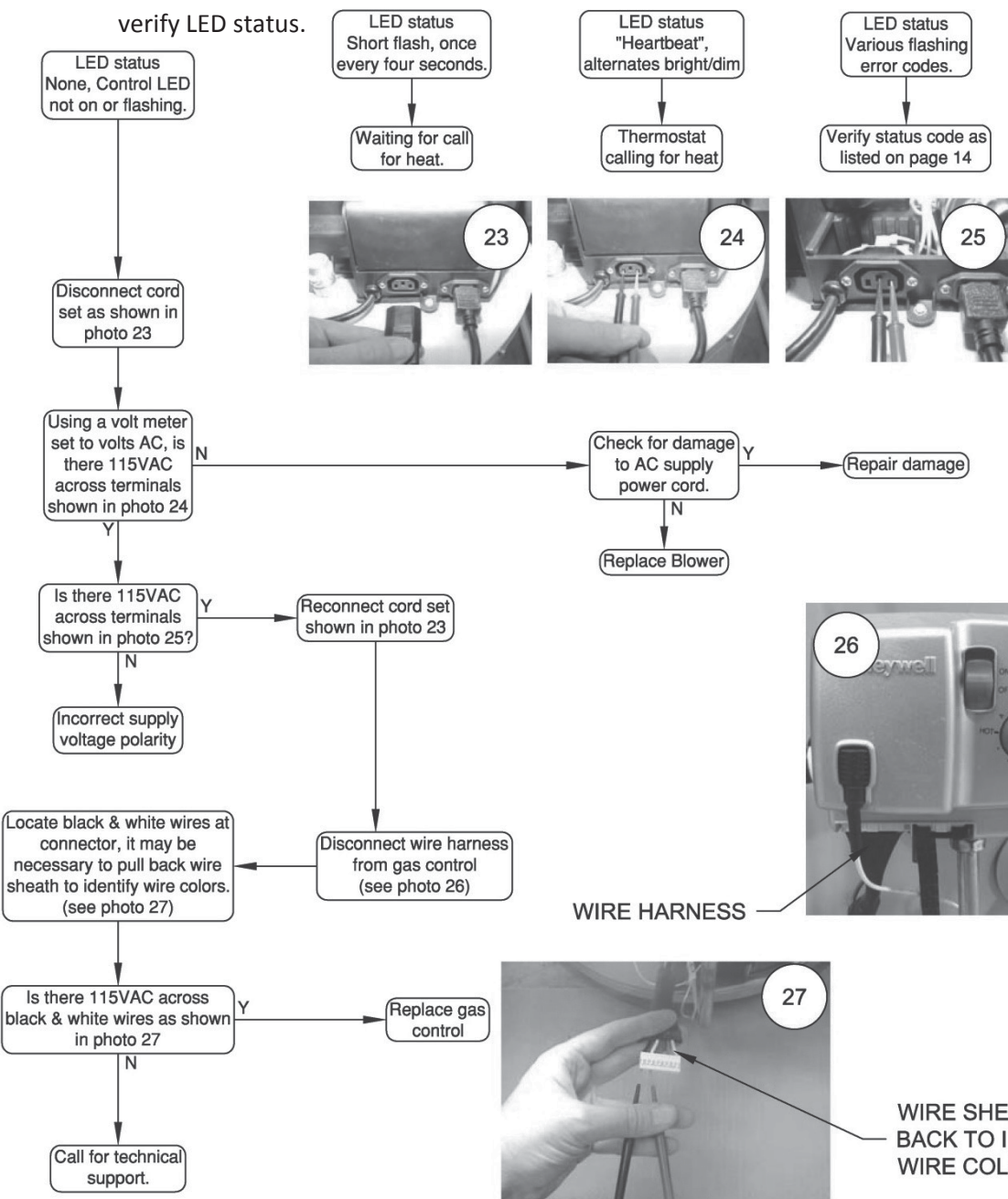

Check for 115VAC between black & white wires.  
-NOTE-  
Electronic meter probes required. Use care not to damage connector during this check.

## Dip Tube Inspection & Replacement

**⚠ WARNING**

**Water Heater components and stored water may be HOT when performing the following steps in this procedure. Take necessary precaution to prevent personal injury.**

- Step 1. Position on/off switch of gas control valve to “OFF” position and unplug water heater from wall outlet.
- Step 2. Turn off cold water supply to water heater. Connect hose to drain valve of water heater and route to an open drain. Open a nearby hot water faucet to vent heater for draining. Open drain valve of water heater and allow heater to drain to a point below the inlet connection nipple.
- Step 3. Disconnect inlet nipple from plumbing system.
- Step 4. With an appropriate tool such as a pipe wrench, remove inlet nipple/dip tube from the water heater. Use caution not to damage pipe threads.
- Step 5. Visually inspect inlet nipple/dip tube. Inlet nipple/dip tube should be free of cracks and any blockage. Hydrojet slots should be open and free of any blockage. Any damage such as cracks, restriction due to deformation or unintentional holes are not field repairable and the inlet nipple/dip tube must be replaced.
- Step 6. Upon completion of inspection or subsequent replacement, reinstall inlet nipple/dip tube into water heater. Ensure pipe dope is used on the nipple’s threads. Connect nipple to plumbing system, resume water supply and refill with water.
- Step 7. To resume operation follow the instructions located on the lighting instruction label or the lighting instructions located in the installation and operation manual.

## Anode Inspection & Replacement

**⚠ WARNING**

**Water Heater components and stored water may be HOT when performing the following steps in this procedure. Take necessary precaution to prevent personal injury.**

- Step 1. Position on/off switch of gas control valve to the "OFF" position and unplug water heater from wall outlet.
- Step 2. Turn off cold water supply to water heater. Connect hose to drain valve of water heater and route to an open drain. Open a nearby hot water faucet to vent water heater for draining. Open drain valve of water heater and allow water heater to drain to a point below the outlet connection nipple.
- Step 3. Disconnect outlet nipple from plumbing system.
- Step 4. With an appropriate tool such as a pipe wrench, remove outlet nipple/anode from the water heater. Use caution not to damage pipe threads.
- Step 5. Visually inspect outlet nipple/anode. Outlet nipple/anode should show signs of depletion, this is normal. If depletion is  $\frac{1}{2}$  of the original anode diameter (approximately  $\frac{3}{4}$ " diameter), replacement is recommended. If any of the steel core of the anode is exposed, replacement is recommended.
- Step 6. Upon completion of inspection or subsequent replacement, reinstall outlet nipple/anode into water heater. Ensure pipe dope is used on the nipple's threads. Connect nipple to plumbing system, resume water supply and refill with water.
- Step 7. To resume operation, follow the instructions located on the lighting instruction label or the lighting instructions located in the installation and operation manual.



## Flue Baffle/Core Inspection and Replacement

- Step 1. Position gas control power switch to the "OFF" position and unplug blower from wall outlet.
- Step 2. Disconnect vent system from exhaust adapter on top of blower.
- Step 3. Disconnect intake air piping.

DISCONNECT VENT SYSTEM FROM EXHAUST ADAPTER

- Step 4. Unplug cord sets from blower (see photo 28).
- Step 5. Remove the three blower mounting screws (1/4" nut driver) (see photo 28).
- Step 6. Remove blower with gasket from water heater.
- Step 7. Remove flue baffle or flue core from heater (see photos 29a and 29b).

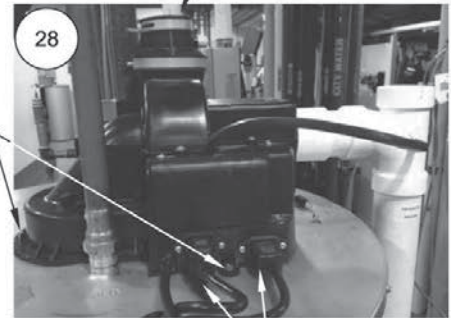

- Step 8. Inspect baffle or core for deterioration, missing restrictors.

Clean any scale or debris build up. Replace with new baffle or core as necessary.

- Step 9. Reinstall baffle or core into flue tube. Be sure hanger tabs are inserted into notch location at the top of the flue tube (see photos 30 & 31).
- Step 10. Check burner to insure no scale has accumulated during this operation. See burner cleaning procedure on page 16.



- Step 11. Reinstall blower on water heater.
- Step 12. Reinstall vent system with the support bracket
- Step 13. Connect cord sets to blower. Plug water heater into wall outlet.

- Step 14. To resume operation follow the lighting instruction location on the lighting instruction label or the lighting instructions located in the installation operation manual.

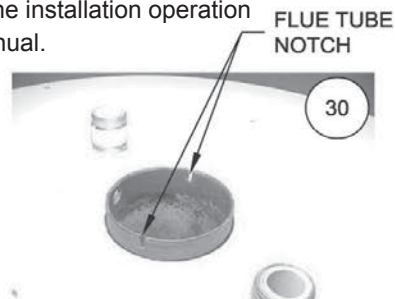
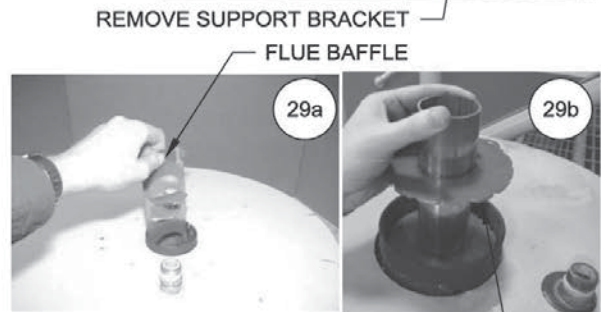

FLUE BAFFLE SHOWN INSTALLED IN FLUE TUBE NOTCHES



## Inner Door Removal Procedure

- Step 1. Position gas control power switch to the "OFF" position.
- Step 2. Remove outer jacket burner access door.
- Step 3. Remove wire tie from feedline.
- Step 4. Remove (2) 1/4" hex drive screws from right side inner door.
- Step 5. Remove (2) 1/4" drive screws from flange section of inner door.
- Step 6. Remove (2) 1/4" drive screws from left side inner door.
- Step 7. Remove inner door and inspect per step 8.

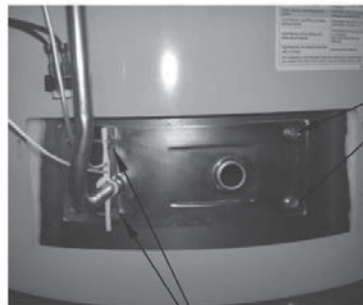

1/4" HEX DRIVE SCREWS  
RIGHT AND LEFT SIDE  
INNER DOOR.

1/4" HEX DRIVE SCREWS  
AT FLANGE AREA OF  
INNER DOOR

- Step 8. Fully inspect inner door gaskets for the following:
- Tears
  - Missing material
  - Cracks
  - Dirt or debris
  - Other imperfections that will inhibit proper seal
  - Gasket adhesion to inner door
  - Material left on combustion chamber (around opening)

If the gasket is not affected by any of the above, gasket replacement is not required. If replacement is required, proceed to [Inner Door Gasket Replacement Procedure](#).

## Inner Door Gasket Replacement Procedure

### **⚠ WARNING**

**If the information in these instructions is not followed exactly, a fire or explosion may result causing property damage, personal injury or death.**

- Step 9. After inspection of inner door as noted in step 8, completely remove gasket and adhesive residue from right and left side inner doors as needed.
- Step 10. Use RTV sealant (recommended bead size 1/8") to secure the inner door gasket to the inner door sections (right & left). Refer to illustration on next page for proper application. Note the overlap configuration in the flange area of the inner door. Set the flange section first, this will help to achieve the proper overlap position.

# PDV Series

## PDV SERVICE PROCEDURE XIII

### Inner Door Removal Inspection & Replacement

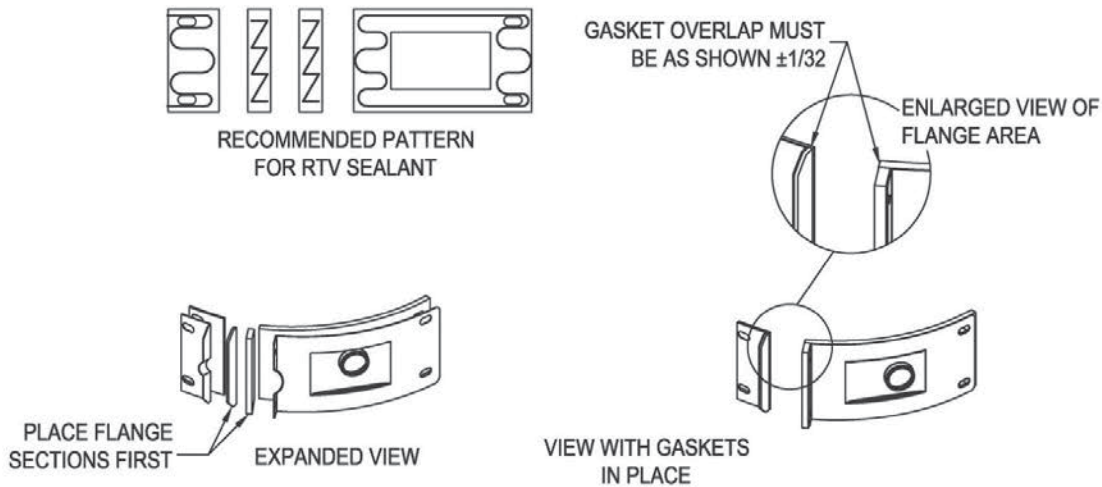

## Installation of Inner Door with Gasket

- Step 11. Clean any residual gasket residue or other debris from combustion chamber surface before installing the inner door/gasket assembly.
- Step 12. Place the left side inner door into position first. Firmly position the radiused channel of the inner door around the feedline. Using the  $1/4$ " hex drive screws from step 6, secure left side inner door in place. **DO NOT OVER TIGHTEN SCREWS**
- Step 13. Position pilot tube and igniter/sensor wire against left side inner door flange gasket. **DO NOT ROUTE THROUGH RADIUSED CHANNEL WITH FEEDLINE.**

**⚠ WARNING**  
Stripped fastener connections may allow for seal breach of inner door. A seal breach may result in a fire or explosion causing property damage, personal injury or death. Do not over tighten screws in steps 12, 14 and 15.

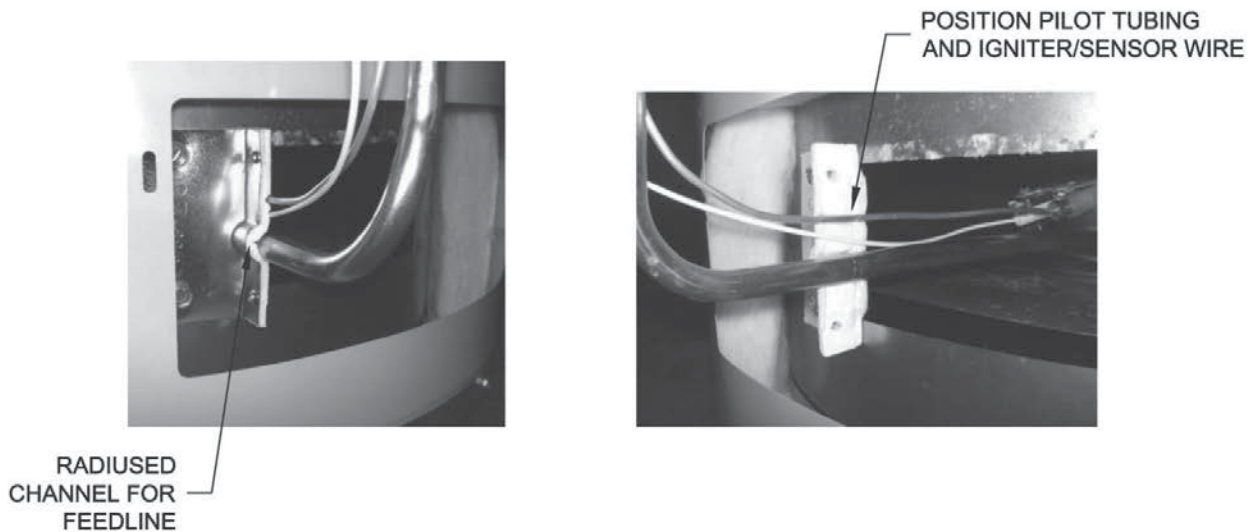

## Installation of Inner Door with Gasket (cont.)

- Step 14. Firmly place right side inner door flange against the left side inner door flange and secure with (2) 1/4" hex drive screws from step 5. **DO NOT OVER TIGHTEN SCREWS.**
- Step 15. Align right side inner door to combustion chamber and verify the fastener holes of the combustion chamber are aligned with right side inner door slotted opening. Verify seal integrity around combustion opening. Secure right side inner door using 1/4" hex drive screws from step 4. **DO NOT OVER TIGHTEN SCREWS.** Verify both left and right sides of inner door are properly positioned and sealed against the combustion chamber.

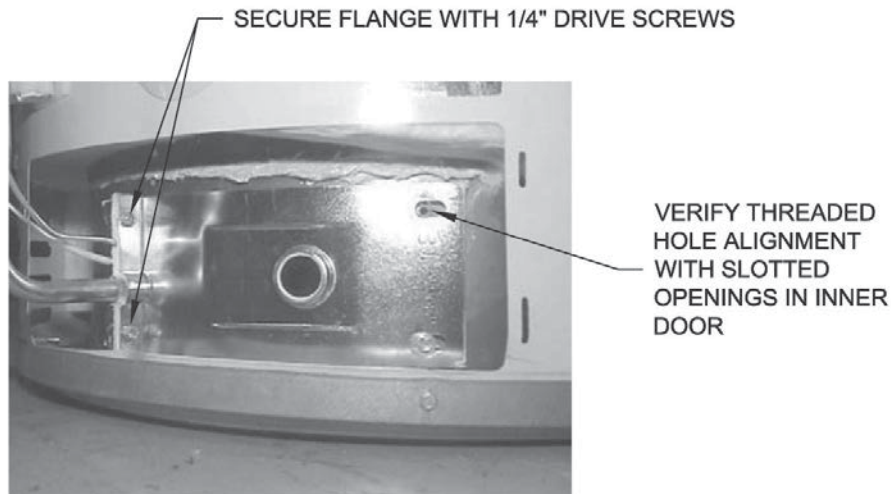

- Step 16. Replace outer jacket burner access door.
- Step 17. To resume operation follow the instructions located on the lighting instruction label or the lighting instructions located in the installation and operation manual.

### Frozen Exhaust Vent Terminal(s)

If an intake or exhaust vent terminal is blocked with ice or snow due to severe conditions, the pressure switch and control will not allow the burner to operate. This will result in a three flash status code. Once the blockage is removed (through melting or other means) the controls will let the burner operate. The position of the vent terminals in relation to each other and terminals from other appliances can have an effect on the potential for blockage due to ice or snow. See the installation instructions for recommended positioning of the terminals.

Testing under severe conditions has shown that the optional concentric vent terminal is resistant to ice blockage. Contact Bradford White or the supplier of the water heater for information about ordering the optional concentric vent terminal.

Bradford White has also developed an air intake relief device that can be installed in the air intake near the water heater temporarily enabling the water heater to operate with a frozen intake terminal. Contact Bradford White or the supplier of the water heater for information about the air intake relief device.

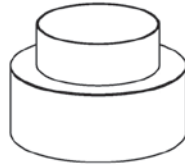

AIR INTAKE RELIEF  
DEVICE

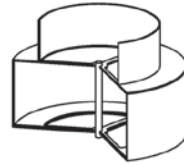

AIR INTAKE RELIEF  
DEVICE  
(SECTION VIEW)

### Glossary of Terms

BTU	British Thermal Units
GPM	Gallons per minute
Hz	Hertz
KWh	kilowatt hour
LED	Light Emitting Diode
NPT	National Pipe Thread
Ohms	Ohms of resistance
PSI	Pounds per square inch
RPM	Revolutions per minute
ECO	Energy Cut Out
VAC	Volts Alternating Current
" W.C.	Inches of Water Column
°C	Degrees Centigrade
°F	Degrees Fahrenheit

# PDV Series

## Parts List

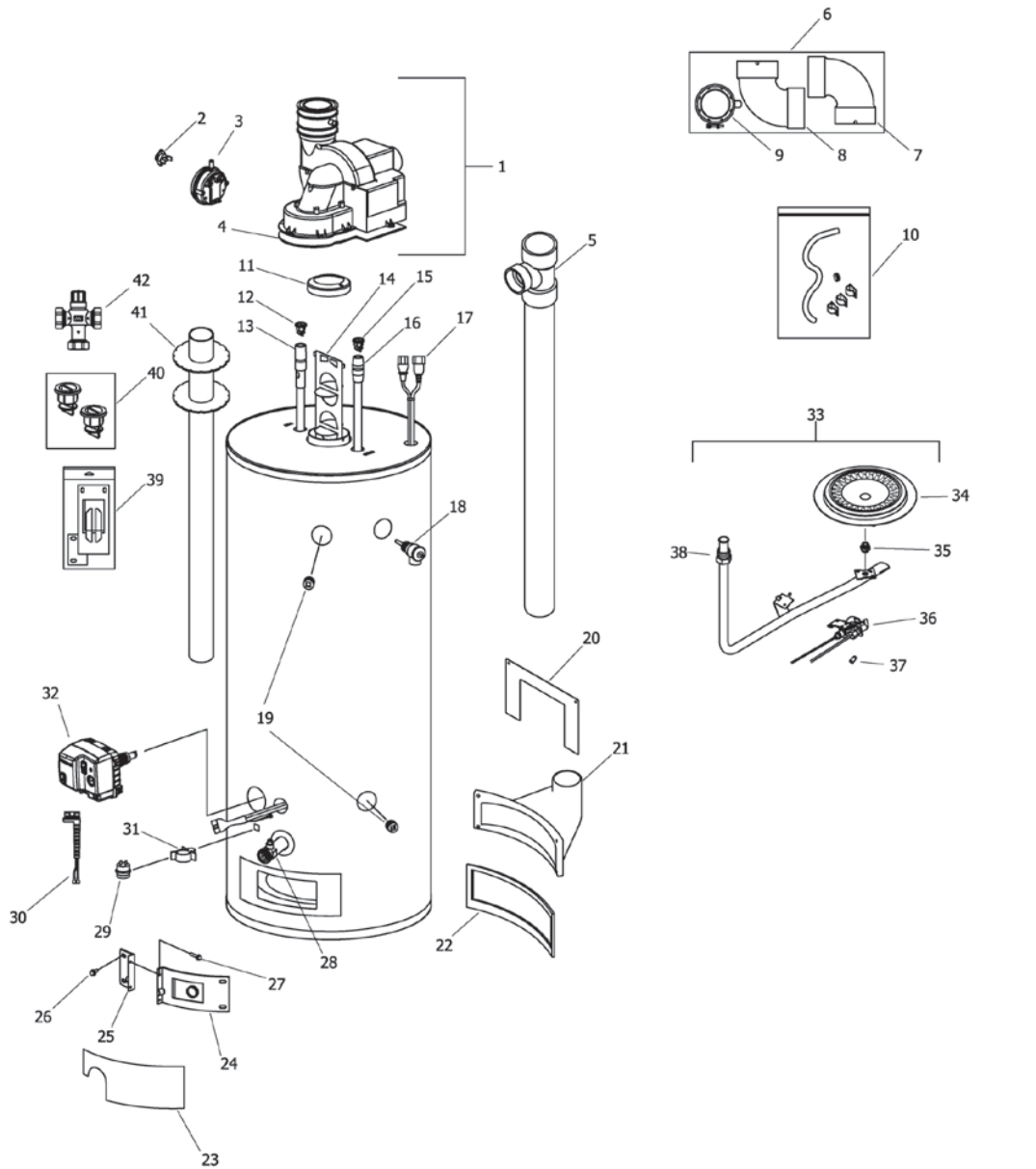

- |                             |                              |                            |                                |
|-----------------------------|------------------------------|----------------------------|--------------------------------|
| 1. Blower Complete          | 12. Heat Trap Outlet         | 22. Air intake boot gasket | 33. Burner Assy.               |
| 2. Temperature Switch       | 13. Hot Water Outlet Anode   | 23. Outer Door             | 34. Main Burner                |
| 3. Pressure Switch          | 14. Flue Baffle (except 75H) | 24. Right side inner door  | 35. Main Burner Orifice        |
| 4. Blower Gasket            | 15. Heat Trap Inlet          | 25. Left side inner door   | 36. Pilot Assy.                |
| 5. Tee and Vent Pipe Ass'y  | 16. Inlet Dip Tube           | 26. Screw #10-12 x 3/4     | 37. Pilot Orifice              |
| 6. Vent Adapter w/ Term.    | 17. Wire Harness             | 27. Screw #8-15 x 3/4      | 38. Feedline                   |
| 7. Intake Terminal          | 18. T&P Valve                | 28. Drain valve            | 39. Inner Door Gasket Kit      |
| 8. Vent Terminal Elbow      | 19. 3/4 NPT Plug             | 29. FV Sensor              | 40. Kit-Heat Trap insert       |
| 9. Exhaust adapter          | 20. Direct Vent boot         | 30. FV Sensor harness      | 41. Flue core (75H only)       |
| 10. Condensate Hose Kit     | 21. Air intake boot          | 31. FV Sensor Clip         | 42. ASSE Approved Mixing Valve |
| 11. Flue Reducer (50H Only) |                              | 32. Gas Control            |                                |





# **BRADFORD WHITE®**

W A T E R H E A T E R S

Ambler, PA

For U.S. and Canada field service,  
contact your professional installer or  
local Bradford White sales representative.

**Sales/800-523-2931**  
**Fax/215-641-1670**  
**Parts Fax/215-641-2180**

**Technical Support/800-334-3393**  
**Fax/269-795-1089**

**Warranty/800-531-2111**  
**Fax/269-795-1089**

**International:**  
**Telephone/215-641-9400**  
**Telefax/215-641-9750**



# **BRADFORD WHITE-CANADA® INC.**

Mississauga, ON

**Sales/866-690-0961**  
**905-238-0100**

**Fax/905-238-0105**

**Technical Support/800-334-3393**

**Email**

**parts@bradfordwhite.com**  
**techserv@bradfordwhite.com**

**www.bradfordwhite.com**