

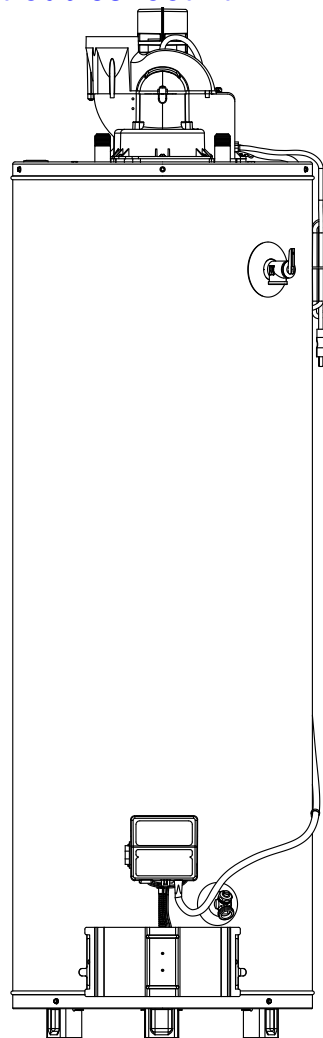

Flammable Vapor Ignition Resistant Compliant

Power Vented Gas Water Heater Installation Instructions and Use & Care Guide



WARNING: If the information in these instructions is not followed exactly, a fire or explosion may result causing property damage, personal injury or death.

Do not store or use gasoline or other flammable vapors and liquids in the vicinity of this or any other appliance.

WHAT TO DO IF YOU SMELL GAS

- Do not try to light any appliance.
- Do not touch any electrical switch; do not use any phone in your building.
- Immediately call your gas supplier from a neighbor's phone. Follow the gas supplier's instructions.
- If you cannot reach your gas supplier, call the fire department.

Installation and service must be performed by a qualified installer, service agency or the gas supplier.

To obtain technical, warranty, or service assistance during or after the installation of this water heater, visit our website at:

<http://www.americanwaterheater.com>

or call toll free
1-800-456-9805

When calling for assistance, please have the following information ready:

1. Model number
2. 7 digit product number
3. Serial number
4. Date of installation
5. Place of purchase

| | |
|-------------------------|---|
| Table of Contents | 2 |
|-------------------------|---|

INSTALLER:

- AFFIX THESE INSTRUCTIONS TO OR ADJACENT TO THE WATER HEATER.

OWNER:





- RETAIN THESE INSTRUCTIONS AND WARRANTY FOR FUTURE REFERENCE. RETAIN THE ORIGINAL RECEIPT AS PROOF OF PURCHASE.



WATER HEATER SAFETY



This is the safety alert symbol. It is used to alert you to potential personal injury hazards. Obey all safety messages that follow this symbol to avoid possible injury or death.

| | |
|---|---|
|  | DANGER indicates an imminently hazardous situation which, if not avoided, could result in death or injury. |
|  | WARNING indicates a potentially hazardous situation which, if not avoided, could result in death or injury. |
|  | CAUTION indicates a potentially hazardous situation which, if not avoided, may result in minor or moderate injury. |
|  | CAUTION used without the safety alert symbol indicates a potentially hazardous situation which, if not avoided, could result in property damage. |

Important Instructions

- Do not use this appliance if any part has been under water. Immediately call a qualified service technician. Water heaters subjected to flood conditions or any time the gas controls, main burner or pilot have been submerged in water require replacement of the entire water heater.
- Hydrogen gas can be produced in a hot water system that has not been used for a long period of time (generally two weeks or more). Hydrogen gas is extremely flammable and can ignite when exposed to a spark or flame. To prevent the possibility of injury under these conditions, we recommend the hot water faucet be opened for several minutes at the kitchen sink before using any electrical appliance which is connected to the hot water system. If hydrogen is present, there will probably be an unusual sound such as air escaping through the faucet as water begins to flow. Do not smoke or have any open flame near the faucet at the time it is open.

The California Safe Drinking Water and Toxic Enforcement Act requires the Governor of California to publish a list of substances known to the State of California to cause cancer, birth defects, or other reproductive harm, and requires businesses to warn of potential exposure to such substances.

WARNING: This product contains a chemical known to the State of California to cause cancer, birth defects, or other reproductive harm.

This appliance can cause low-level exposure to some of the substances included in the Act.

Table Of Contents

| | PAGE |
|--|-------|
| Water Heater Safety | 2 |
| Installing Your Gas Water Heater | 3-14 |
| Unpacking the Water Heater | 3 |
| Location Requirements | 4-5 |
| Gas Supply | 6 |
| Combustion Air Supply/Vent Pipe System | 7-12 |
| Outlet Terminations | 12 |
| Water System Piping | 13 |
| Electrical Connections | 15 |
| Installation Checklist | 16 |
| Operating Your Water Heater | 17-19 |
| Lighting Instructions | 17 |
| Operational Conditions | 19 |
| Maintenance of Your Water Heater | 20-22 |
| Troubleshooting Flowchart | 23-24 |
| Repair Parts Illustration | 25-26 |

INSTALLING YOUR GAS WATER HEATER

Consumer Information

This water heater is design-certified by CSA International as a Category IV, non-direct vented water heater which takes its combustion air either from the installation area or from air ducted to the unit from the outside.

This water heater must be installed according to all local and state codes or, in the absence of local and state codes, the "National Fuel Gas Code", ANSI Z223.1(NFPA 54)-current edition.

CSA America, Inc.
8501 East Pleasant Valley Road
Cleveland, OH 44131

National Fire Protection Association
1 Batterymarch Park
Quincy, MA 02269

Check your phone listings for the local authorities having jurisdiction over your installation.

Consumer Responsibilities

This manual has been prepared to acquaint you with the installation, operation, and maintenance of your gas water heater and provide important safety information in these areas.

Read all of the instructions thoroughly before attempting the installation or operation of this water heater.

Do not discard this manual. You or future users of this water heater will need it for future reference.

Service to the power vented system should only be performed by a qualified person.

Examples of a qualified person include: licensed plumbers, authorized gas company personnel, and authorized service personnel.

If you lack the necessary skills required to properly install this water heater, or you have difficulty following the instructions, you should not proceed but have a qualified person perform the installation of this water heater.

Massachusetts code requires this water heater to be installed in accordance with Massachusetts Plumbing and Fuel Gas Code 248 CMR Section 2.00 and 5.00.

A data plate identifying your water heater can be found next to the gas control valve/thermostat. When referring to your water heater, always have the information listed on the data plate readily available.

Retain your original receipt as proof of purchase.

Unpacking the Water Heater

WARNING

Excessive Weight Hazard

Use two or more people to move and install water heater.

Failure to do can result in back or other injury.

IMPORTANT: Do not remove any permanent instructions, labels, or the data label from either the outside of the water heater or on the inside of water heater panels.

- Remove exterior packaging and place installation components aside.
- Inspect all parts for damage prior to installation and start-up.
- Completely read all instructions before attempting to assemble and install this product.
- After installation, dispose of/recycle all packaging materials.

⚠️ WARNING

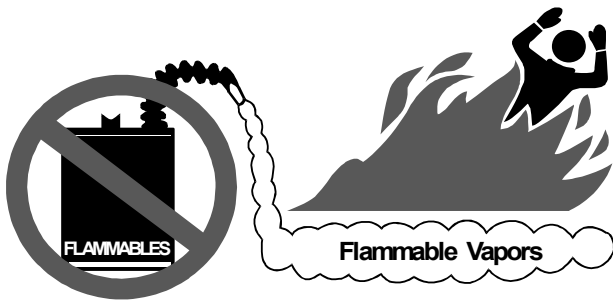

FIRE AND EXPLOSION HAZARD

Can result in serious injury or death

⚠️ Do not store or use gasoline or other flammable vapors and liquids in the vicinity of this or any other appliance. Storage of or use of gasoline or other flammable vapors or liquids in the vicinity of this or any other appliance can result in serious injury or death.

Read and follow water heater warnings and instructions.

Location Requirements

⚠️ WARNING

Carbon Monoxide Poisoning Hazard

Do not install in a mobile home.

Doing so can result in death or carbon monoxide poisoning.

Do not use or store flammable products such as gasoline, solvents, or adhesives in the same room or area near the water heater. If such flammables must be used, all gas burning appliances in the vicinity must be shut off and their pilot lights extinguished. Open the doors and windows for ventilation while flammable substances are in use.

If flammable liquids or vapors have spilled or leaked in the area of the water heater, leave the area immediately and call the fire department from a neighbor's home. Do not attempt to clean the spill until all ignition sources have been extinguished.

⚠️ WARNING

Fire or Explosion Hazard

Read instruction manual before installing, using or servicing water heater.

Improper use may result in fire or explosion.

Maintain required clearances to combustibles.

Keep combustibles such as boxes, magazines, clothes, etc. away from the water heater area.

Site Location

- Select a location near the center of the water piping system. The water heater must be installed indoors and in a vertical position on a level surface.
- Consider the exhaust vent system piping and combustion air supply requirements when selecting the water heater location. The venting system must be able to run from the water heater to the termination with a minimal length and number of elbows. The venting system must comply with the requirements set forth in the venting section of this manual.
- Locate the water heater near the existing gas piping. If installing a new gas line, locate the water heater to minimize the pipe length and elbows.

NOTE: This water heater must be installed according to all local and state codes or, in the absence of local and state codes, the "National Fuel Gas Code", ANSI Z223.1(NFPA 54)-current edition.

CAUTION - PROPERTY DAMAGE HAZARD

The water heater should be located in an area where leakage of the tank or connections will not result in damage to the area adjacent to the water heater or to lower floors of the structure. Due to the normal corrosive action of the water, the tank will eventually leak after an extended period of time. Also any external plumbing leak, including those from improper installation, may cause early failure of the tank due to corrosion if not repaired. If the owner/operator is uncomfortable with making the repair a qualified person should be contacted. A suitable metal drain pan should be installed under the water heater as shown below, to help protect the property from damage which may occur from condensate formation or leaks in the piping connections or tank. The pan must limit the water level to a maximum depth of 1-3/4" and be two inches wider than the heater and piped to an adequate drain. NOTE: The pan must not restrict combustion air flow. Locate the water heater near a suitable indoor drain. Outside drains are subject to freezing temperatures which can obstruct the drain line. The piping should be at least 3/4" ID and pitched for proper drainage.

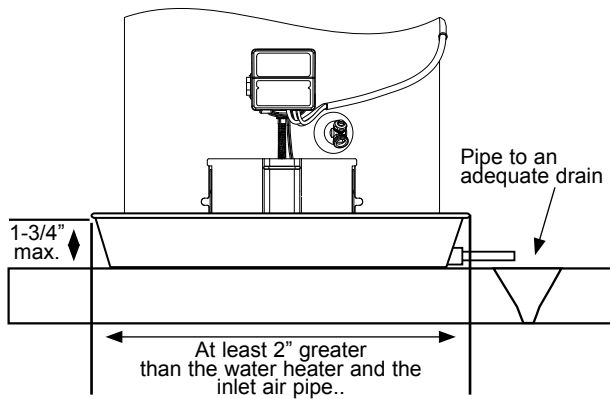

- The water heater should be located in an area not subject to freezing temperatures. Water heaters located in unconditioned spaces (i.e., attics, basements, etc.) may require insulation of the water piping and drain piping to protect against freezing. The drain and controls must be easily accessible for operation and service. Maintain proper clearances as specified on the data plate.
- Do not locate the water heater near an air-moving device. The operation of air-moving devices such as exhaust fans, ventilation systems, clothes dryers, fireplaces, etc., can affect the proper operation of the water heater. Special attention must be given to conditions these devices may create. Flow reversal of flue gases may cause an increase of carbon monoxide inside of the dwelling.

Clearances and Accessibility

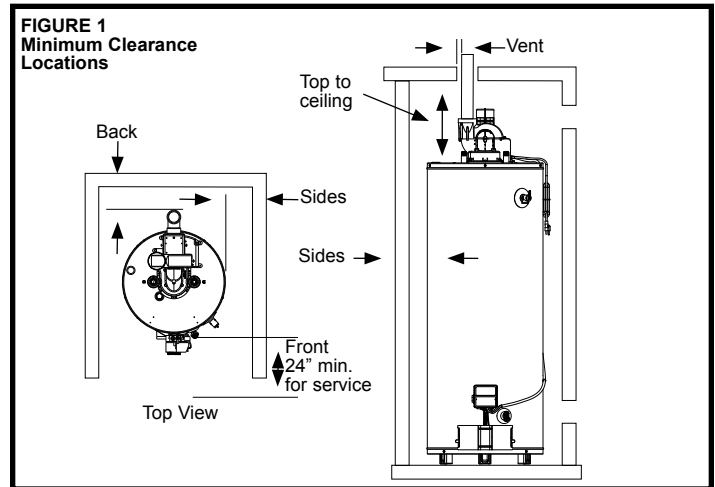

NOTE: Minimum clearances from combustible materials are stated on the data plate adjacent to the gas control valve/thermostat of the water heater.

The water heater is certified for installation on a combustible floor.

- **IMPORTANT:** If installing over carpeting, the carpeting must be protected by a metal or wood panel beneath the water heater. The protective panel must extend beyond the full width and depth of the water heater by at least 3 inches (76.2mm) in any direction or if in a alcove or closet installation, the entire floor must be covered by the panel.

⚠ WARNING

Fire Hazard



For continued protection against the risk of fire:

Do not install water heater on carpeted floor.

Do not operate water heater if flood damaged.

- Figure 1 may be used as a reference guide to locate the specific clearance locations. A minimum of 24 inches of front clearance and 4 inches on each side should be provided for inspection and service.

State of California

NOTE: The water heater must be braced, anchored, or strapped to avoid moving during an earthquake. Contact local utilities for code requirements in your area or call 1-800-456-9805 and request instructions.

Gas Supply

⚠️ WARNING



Explosion Hazard

Use a new CSA approved gas supply line.

Install a shut-off valve.

Do not connect a natural gas water heater to an L.P. gas supply.

Do not connect an L.P. gas water heater to a natural gas supply.

Failure to follow these instructions can result in death, explosion, or carbon monoxide poisoning.

Gas Requirements

Read the data plate to be sure the water heater is made for the type of gas you will be using in your home. This information will be found on the data plate located near the gas control valve/thermostat. If the information does not agree with the type of gas available, do not install or light. Call your dealer.

NOTE: An odorant is added by the gas supplier to the gas used by this water heater. This odorant may fade over an extended period of time. Do not depend upon this odorant as an indication of leaking gas.

Gas Piping

The gas piping must be installed according to all local and state codes or, in the absence of local and state codes, the "National Fuel Gas Code", ANSI Z223.1(NFPA 54)-current edition.

Tables 1 and 2 on the following page provide a sizing reference for commonly used gas pipe materials. Consult the "National Fuel Gas Code" for the recommended gas pipe size of other materials.

Refer to Figure 2

NOTE: When installing gas piping, apply approved pipe joint compound.

1. Install a readily accessible manual shut-off valve in the gas supply line as recommended by the local utility. Know the location of this valve and how to turn off the gas to this unit.
2. Install a drip leg (if not already incorporated as part of the water heater) as shown. The drip leg must be no less than three inches long for the accumulation of dirt, foreign material, and water droplets.
3. Install a ground joint union between the gas control valve/thermostat and the manual shut-off valve. This is to allow easy removal of the gas control valve/thermostat.
4. Turn the gas supply on and check for leaks. Test all connections by brushing on an approved noncorrosive leak-detection solution. Bubbles will show a leak. Correct any leak found.

Figure 2
Gas Piping

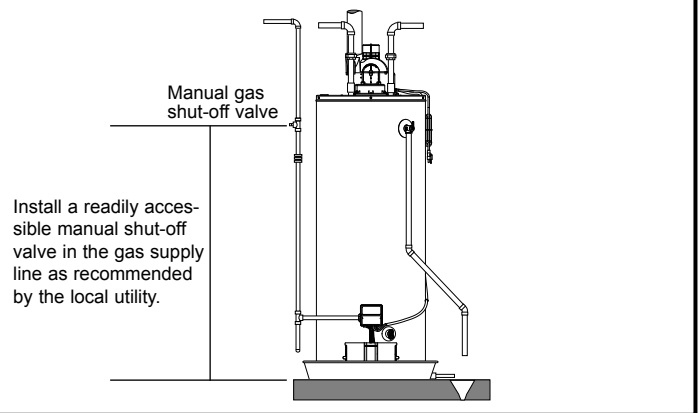

Gas Pressure

IMPORTANT: The gas supply pressure must not exceed the maximum supply pressure as stated on the water heater's data plate. The minimum supply pressure is for the purpose of input adjustment.

Gas Pressure Testing

IMPORTANT: This water heater and its gas connection must be leak tested before placing the appliance in operation.

- If the code requires the gas lines to be tested at a pressure exceeding 14" W.C., the water heater and its manual shut-off valve must be disconnected from the gas supply piping system and the line capped.
- If the gas lines are to be tested at a pressure less than 14" W.C., the water heater must be isolated from the gas supply piping system by closing its manual shut-off valve.

U.L. recognized fuel gas and carbon monoxide (CO) detectors are recommended in all applications and should be installed using the manufacturer's instructions and local codes, rules, or regulations.

NOTE: Air may be present in the gas lines and could prevent the burner from lighting on initial start-up. The gas lines should be purged of air by a qualified person after installation of the gas piping system.

L.P. Gas Only

⚠️ WARNING



Explosion Hazard

Have a qualified person make sure L.P. gas pressure does not exceed 13" water column.

Examples of a qualified person include: licensed plumbers, authorized gas company personnel, and authorized service personnel.

Failure to do so can result in death, explosion, or fire.

Table 1
Natural Gas Pipe Capacity Table (Cu. Ft./Hr.)
 Capacity of gas pipe of different diameters and lengths in cu. ft. per hr. with pressure drop of 0.3 in. and specific gravity of 0.60 (natural gas.)

| Nominal Iron Pipe Size, in. | Length of Pipe, Feet | | | | | | | | | | | | | |
|-----------------------------|----------------------|------|-----|-----|-----|-----|-----|-----|-----|-----|-----|-----|-----|-----|
| | 10 | 20 | 30 | 40 | 50 | 60 | 70 | 80 | 90 | 100 | 125 | 150 | 175 | 200 |
| 1/2 | 132 | 92 | 73 | 63 | 56 | 50 | 46 | 43 | 40 | 38 | 34 | 31 | 28 | 26 |
| 3/4 | 278 | 190 | 152 | 130 | 115 | 105 | 96 | 90 | 84 | 79 | 72 | 64 | 59 | 55 |
| 1 | 520 | 350 | 285 | 245 | 215 | 195 | 180 | 170 | 160 | 150 | 130 | 120 | 110 | 100 |
| 1-1/4 | 1050 | 730 | 590 | 500 | 440 | 400 | 370 | 350 | 320 | 305 | 275 | 250 | 225 | 210 |
| 1-1/2 | 1600 | 1100 | 890 | 760 | 670 | 610 | 560 | 530 | 490 | 460 | 410 | 380 | 350 | 320 |

After the length of pipe has been determined, select the pipe size which will provide the minimum cubic feet per hour required for the gas input rating of the water heater. By formula:

$$\text{Min. Cu. Ft. Per Hr. Required} = \frac{\text{Gas Input of Water Heater (BTU/HR)}}{\text{Heating Value of Gas (BTU/FT}^3\text{)}}$$

The gas input of the water heater is marked on the water heater data plate. The heating value of the gas (BTU/FT³) may be determined by consulting the local natural gas utility.

Table 2
LP Gas Capacity Table
 Maximum capacity of pipe in thousands of BTU per hour of undiluted liquefied petroleum gases (at 11 inches water column pressure.) Based on a pressure drop of 0.5 inch water column.

| Nominal Iron Pipe Size, in. | Length of Pipe, Feet | | | | | | | | | | | | |
|-----------------------------|----------------------|------|------|------|-----|-----|-----|-----|-----|-----|-----|-----|--|
| | 10 | 20 | 30 | 40 | 50 | 60 | 70 | 80 | 90 | 100 | 125 | 150 | |
| 1/2 | 275 | 189 | 152 | 129 | 114 | 103 | 96 | 89 | 83 | 78 | 69 | 63 | |
| 3/4 | 576 | 393 | 315 | 267 | 237 | 217 | 196 | 185 | 173 | 162 | 146 | 132 | |
| 1 | 1071 | 732 | 590 | 504 | 448 | 409 | 378 | 346 | 322 | 307 | 275 | 252 | |
| 1-1/4 | 2205 | 1496 | 1212 | 1039 | 913 | 834 | 771 | 724 | 677 | 630 | 567 | 511 | |

Example: Input BTU requirement of the water heater 100,000 BTUH.
 Total pipe length, 80 feet = 3/4" IPS required.

Additional tables are available in the latest edition of the "National Fuel Gas Code", ANSI Z223.1.

Combustion Air Supply and Ventilation

⚠ WARNING

Carbon Monoxide Warning

Follow all the local and state codes or, in the absence of local and state codes, the "National Fuel Gas Code", ANSI Z223.1 (NFPA 54)- latest edition to properly install vent system.

Failure to do so can result in death, explosion, or carbon monoxide poisoning.

Combustion Air Supply

This water heater takes its combustion air either from the installation area or from air ducted to the unit from the outside and all combustion products are discharged to the outdoors.

IMPORTANT: Air for combustion and ventilation must not come from a corrosive atmosphere. Any failure due to corrosive elements in the atmosphere is excluded from warranty coverage.

The following types of installation (not limited to the following) will require outdoor air for combustion due to chemical exposure and may reduce but not eliminate the presence of corrosive chemicals in the air:

- beauty shops
- photo processing labs
- buildings with indoor pools
- water heaters installed in laundry, hobby, or craft rooms
- water heaters installed near chemical storage areas

Combustion air must be free of acid-forming chemicals such as sulfur, fluorine, and chlorine. These elements are found in aerosol sprays, detergents, bleaches, cleaning solvents, air fresheners, paint, and varnish removers, refrigerants, and many other commercial and household products. When burned, vapors from these products form highly corrosive acid compounds. These products should not be stored or used near the water heater or air inlet.

Combustion and ventilation air requirements are determined by the location of the water heater. The water heater may be located in either an open (unconfined) area or in a confined area or small enclosure such as a closet or small room. Confined spaces are areas with less than 50 cubic feet for each 1,000 BTUH of the total input for all gas-using appliances.

⚠ WARNING



Fire and Explosion Hazard

Combustion air is drawn through the bi-directional air vent above the water heater.

Do not store gasoline or other flammable substances above this water heater. Storage of gasoline or other flammable substances above this water heater can result in serious injury or death.

Unconfined Space

A water heater in an unconfined space uses indoor air for combustion and requires at least 50 cubic feet for each 1,000 BTUH of the total input for all gas appliances. The table below shows a few examples of the minimum square footage (area) required for various BTUH inputs.

| BTUH Input | Min. Sq. Feet with 8' Ceiling | Typical Room with 8' Ceiling |
|------------|-------------------------------|------------------------------|
| 30,000 | 188 | 9 x 21 |
| 45,000 | 281 | 14 x 20 |
| 60,000 | 375 | 15 x 25 |
| 75,000 | 469 | 15 x 31 |
| 90,000 | 563 | 20 x 28 |
| 105,000 | 657 | 20 x 33 |
| 120,000 | 750 | 25 x 30 |
| 135,000 | 844 | 28 x 30 |

IMPORTANT:

- The area must be open and be able to provide the proper air requirements to the water heater. Areas that are being used for storage or contain large objects may not be suitable for water heater installation.
- Water heaters installed in open spaces in buildings with unusually tight construction may still require outdoor air to function properly. In this situation, outside air openings should be sized the same as for a confined space.
- Modern home construction usually requires supplying outside air into the water heater area.

Confined Space

For the correct and proper operation of this water heater, ample air must be supplied for the combustion, ventilation, and dilution of flue gases. Small enclosures and confined areas must have two permanent openings so that sufficient fresh air can be drawn from outside of the enclosure. One opening shall be within 12 inches of the top and one within 12 inches of the bottom of the enclosure as shown in Figure 3.

The size of each opening (free area) is determined by the total BTUH input of all gas utilization equipment (i.e., water

heaters, furnaces, clothes dryers, etc.) and the method by which the air is provided. The BTUH input can be found on the water heater data plate. Additional air can be provided by two methods:

1. All air from inside the building.
2. All air from outdoors.

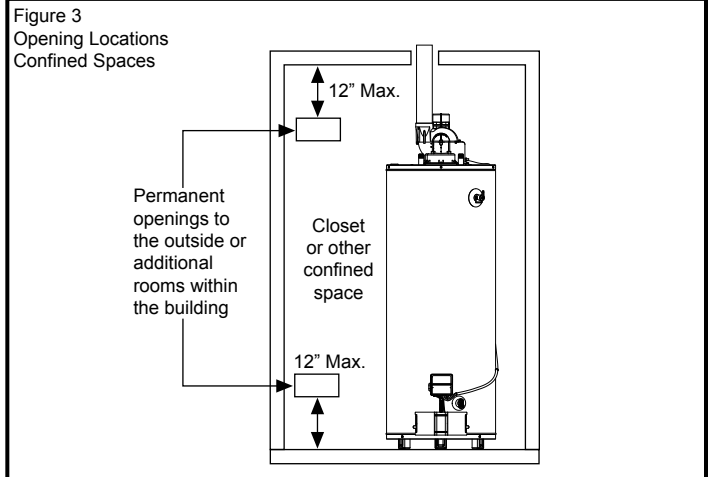

All Air from Inside the Building

When additional air is to be provided to the confined area from additional room(s) within the building, the total volume of the room(s) must be of sufficient size to properly provide the necessary amount of fresh air to the water heater and other gas utilization equipment in the area. If you are unsure that the structure meets this requirement, contact your local gas utility company or other qualified agency for a safety inspection.

Each of the two openings shall have a minimum free area of 1 square inch per 1,000 BTUH of the total input rating of all gas utilization equipment in the confined area, but not less than 100 square inches (Figure 4).

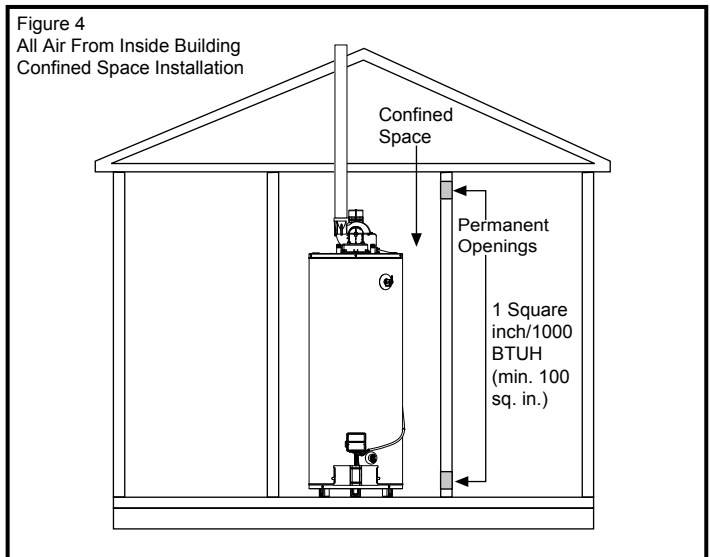

All Air from Outdoors

Outdoor fresh air can be provided to a confined area either directly or by the use of vertical and horizontal ducts. The fresh air can be taken from the outdoors or from crawl or attic spaces that freely communicate with the outdoors. Attic or crawl spaces cannot be closed and must be properly ventilated to the outside.

Ductwork must be of the same cross-sectional area as the free area of the opening to which they connect. The

minimum dimension of rectangular air ducts cannot be less than three inches.

The size of each of the two openings is determined by the method in which the air is to be provided. Refer to Table 4 to calculate the minimum free area for each opening. Figures 5, 6, and 7 are typical examples of each method.

Louvers and Grilles

In calculating free area for ventilation and combustion air supply openings, consideration must be given to the blocking effect of protection louvers, grilles, and screens. These devices can reduce airflow, which in turn may require larger openings to achieve the required minimum free area. Screens must not be smaller than 1/4" mesh. If the free area through a particular design of louver or grille is known, it should be used in calculating the specified free area of the opening. If the design and free area are not known, it can be assumed that most wood louvers will allow 20 - 25% of free area while metal louvers and grilles will allow 60 - 75% of free area.

Louvers and grilles must be locked open or interconnected with the equipment so that they are opened automatically during equipment operation.

Keep louvers and grilles clean and free of debris or other obstructions.

Table 4

Minimum Free Area of Permanent Openings for Ventilation and Combustion Air Supply - All Air from Outdoors Only

Based on the total BTUH input rating for all gas utilizing equipment within the confined space.

| Opening Source | Minimum Free Area Per Opening (Sq. In.) | Reference Drawing |
|-----------------------|---|-------------------|
| Directed to Outdoors* | 1 sq. in. per 4000 BTUH | Figure 5 |
| Vertical Ducts | 1 sq. in. per 4000 BTUH | Figure 6 |
| Horizontal Ducts | 1 sq. in. per 2000 BTUH | Figure 7 |
| Single Opening | 1 sq. in. per 3000 BTUH | Figure 7A |

Example: A water heater with an input rating of 50,000 BTUH using horizontal ducts would require each opening to have a minimum free area of 25 square inches.

Minimum free area = 50,000 BTUH x 1 sq. in. / 2000 BTUH = 25 sq. in.

*These openings connect directly with the outdoors through a ventilated attic, a ventilated crawl space, or through an outside wall.

Consult the local codes of your area for specific ventilation and combustion air requirements.

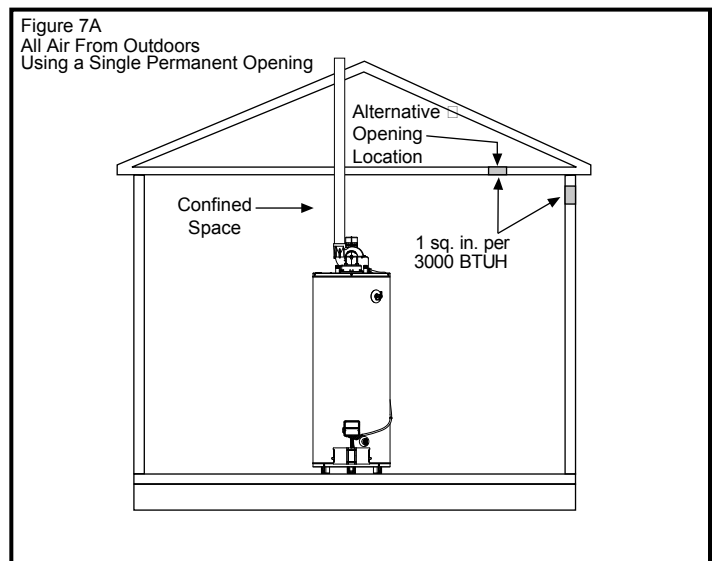
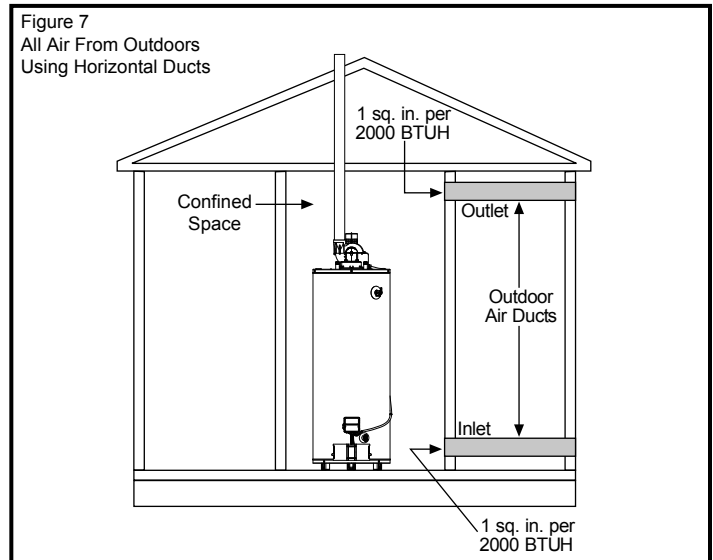
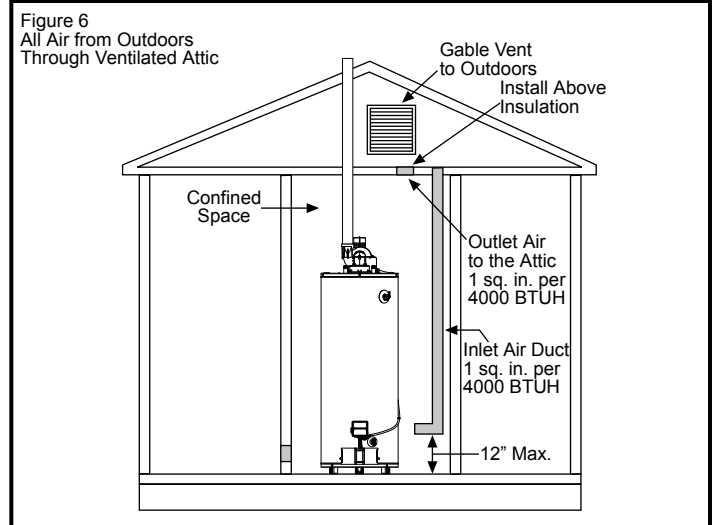
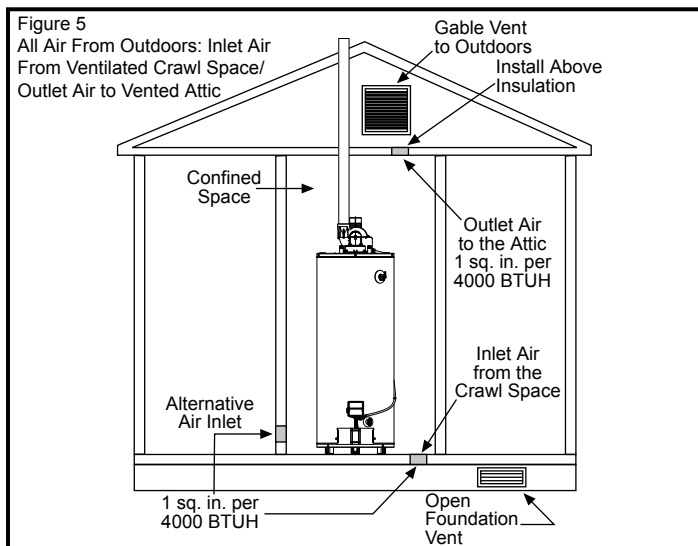

Vent Pipe System

This water heater must be properly vented for removal of exhaust gases to the outside atmosphere. Correct installation of the vent pipe system is mandatory for the safe and efficient operation of this water heater and is an important factor in the life of the unit.

The vent pipe must be installed in accordance with state and local codes, or in the absence of such, the National Fuel Gas Code, NFPA 54, ANSI Z223.1-current edition.

IMPORTANT: Check to make sure the vent pipe is not blocked in any way. **NOTE:** Do not common vent this water heater with any other appliance. Do not install in the same chase or chimney with a metal or high-temperature plastic from another gas or fuel burning appliance.

Vent Pipe Material

The following plastic materials may be used for both the combustion air inlet and exhaust outlet piping subject to state and local codes:

- 2 or 3 inch Schedule 40 PVC or ABS
- 2 or 3 inch Schedule 40 or 80 CPVC
- DWV Pipe is acceptable

NOTE: Use only solid (not foam core) piping. Plastic pipe and fittings are available through most plumbing suppliers. Always check the marking on the pipe to make sure you are using the correct material.

Vent Pipe Connection to Blower

A 3"x2" condensate drain coupler is supplied with every 40-42K BTU model to connect either 2" or 3" venting to the blower. A 3" condensate drain coupler is supplied with every 50-60K BTU model to connect 3" venting to the blower.

IMPORTANT: These connections must be properly sealed to prevent the leakage of the products of combustion into the living area. If needed 3"x2" & 3" condensate drain couplers are available through the Parts Department for new installations or retrofits where condensate may run back to the blower.

Vent Pipe Installation

The following guidelines should be followed when installing the exhaust outlet piping:

- Venting should be as direct as possible with a minimum number of pipe fittings.
- Vent diameter must not be reduced unless specifically noted in the installation instructions.
- Support all horizontal pipe runs every four feet and all vertical pipe runs every six feet or according to local codes.
- Vents run through unconditioned spaces where below freezing temperatures are expected should be properly insulated to prevent freezing. For horizontal runs, wrap the vent pipe with self-regulating 3 or 5 watt heat tape. The heat tape must be U.L. listed and installed per the manufacturer's instructions.
- Do not connect this venting system with an existing vent or chimney.
- Do not common vent with the vent pipe of any other water heater or appliance.

The exhaust outlet piping and termination may be installed in one of the following type terminations:

1. Standard Horizontal
2. Vertical

All pipe, fittings, pipe cement, primers and procedures must conform to American National Standard Institute and American Society for Testing and Materials (ANSI/ASTM) standards in the United States. This water heater has been design certified by CSA International for use with the listed plastic vent pipe material. **IMPORTANT:** Do not use vent elbows in this vent pipe installation (see figure 8). All joints in the outlet piping must be properly cemented. Size and cut all piping before cementing.

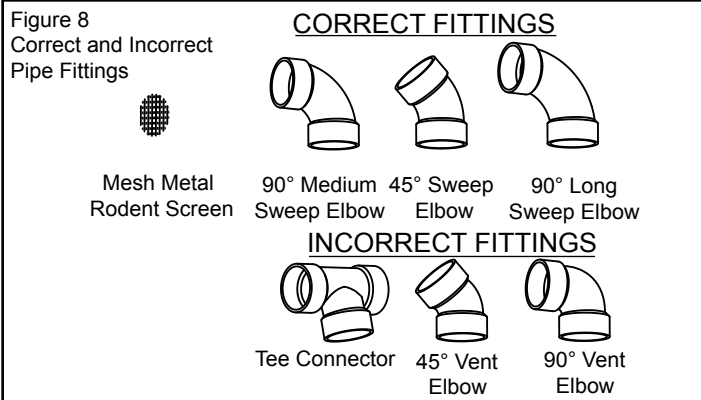

1. Cut the pipe end square and remove all ragged edges and burrs. Make sure the inside of the pipe is clean and free of cuttings and loose dirt. Chamfer the end and apply primer to the fitting and pipe.
2. Using a suitable grade of pipe cement, apply a moderate, even coat inside the fitting. Apply a liberal amount of cement to the outside of the pipe to socket depth. **NOTE:** It is important to select the proper pipe cement for the type plastic pipe being used.
3. Assemble the parts quickly while the cement is still wet. Twist the pipe 1/4 turn during insertion and hold for 30 seconds.

Vent Pipe Length

Size the exhaust outlet as specified in Tables 5 & 6 below. These tables list the maximum allowable length in feet of the exhaust outlet pipe as related to the number of required elbows and the termination. The specified maximum lengths are for exhaust pipe systems. Minimum pipe length is 3 feet with one elbow.

1. Determine termination type and pipe size.
2. Determine number of elbows in exhaust pipe (Do not include elbows in the termination.) Corresponding number indicates the maximum length of exhaust pipe.

Table 5 - Maximum Allowable Length in Feet of Exhaust Pipe - (42K BTU/Hr models only)

| Pipe Size (in) | Number of 90° Elbows (medium or long sweep only) | | | | | | | Termination Options |
|----------------|--|-----|-----|-----|-----|----|----|---------------------|
| | 0 | 1 | 2 | 3 | 4 | 5 | 6 | |
| 2 | 40 | 35 | 30 | 25 | 20 | 15 | 10 | Std. Horizontal |
| 2 | 40 | 35 | 30 | 25 | 20 | 15 | 10 | Vertical |
| 3 | 120 | 115 | 110 | 105 | 100 | 95 | 90 | Std. Horizontal |
| 3 | 120 | 115 | 110 | 105 | 100 | 95 | 90 | Vertical |

Table 6 - Maximum Allowable Length in Feet of Exhaust Pipe - (50K/60K BTU/Hr models only)

| Pipe Size (in) | Number of 90° Elbows (medium or long sweep only) | | | | | | | Termination Options |
|----------------|--|----|----|----|----|----|----|---------------------|
| | 0 | 1 | 2 | 3 | 4 | 5 | 6 | |
| 2 | N/A | | | | | | | Std. Horizontal |
| 2 | N/A | | | | | | | Vertical |
| 3 | 65 | 60 | 55 | 50 | 45 | 40 | 35 | Std. Horizontal |
| 3 | 65 | 60 | 55 | 50 | 45 | 40 | 35 | Vertical |

Notes:

1. N/A - Not Applicable
2. The above maximum lengths are for outlet pipe systems.
3. Maximum of 6 elbows may be used. Use only medium or long sweep elbows. See figure 8 for details.
4. Two 45° elbows are considered equivalent to one 90° elbow.
5. Minimum length is 3 foot with 1 elbow.
6. Use schedule 40 or 80 CPVC, 40 ABS, or 40 PVC pipe and fittings.

Vent Termination Locations

The exhaust outlet must be installed with the following minimum clearances (see figure 9):

- Twelve inches above grade or maximum anticipated snow level.
- Twelve inch minimum clearance on top or four foot clearance below or to the side of door or window that may be open.
- Four feet horizontally and vertically from gas or electric meters, gas regulators, dryer vents, vent hoods, bathroom fan exhaust, attic fans and turbines.
- Two feet from an inside corner formed by two exterior walls.
- Two feet from porches, decks, overhangs and other obstructions.

In addition to maintaining the minimum clearances , the vent should terminate according to the following guidelines:

1. Do not expose any reducers or bushings to outdoor ambient temperatures.
2. The exhaust outlet must not terminate under a patio, deck or any covered area.
3. Do not terminate the vent near walkways or into alleys or other publicly accessible areas.
4. Do not terminate the vent in an area where children or animals could block pipes.
5. Do not locate the vent terminal too close to shrubs or bushes.
6. Caulk all cracks, seams and joints within 6 feet horizontally above and below the vent.

Figure 9
Minimum Termination Clearance for
Outlet Vent

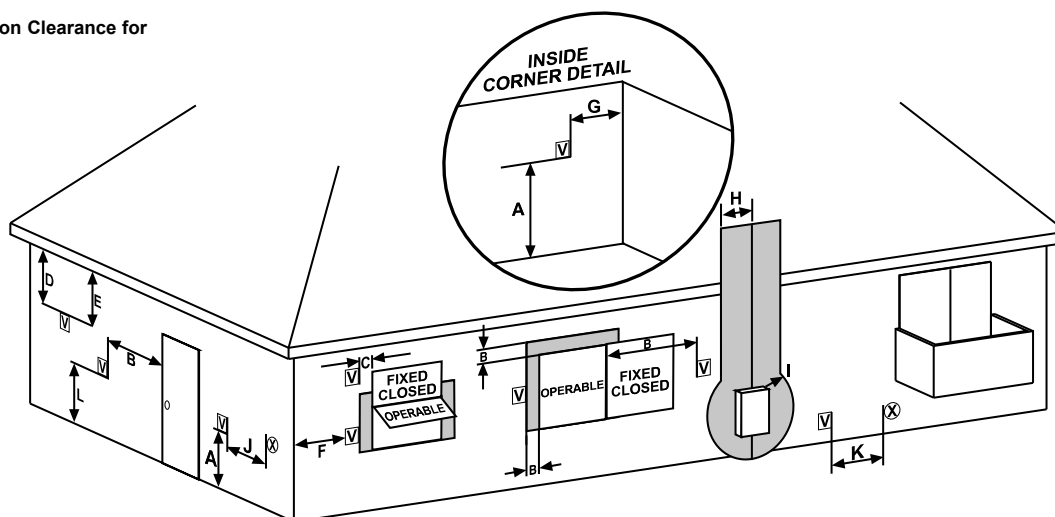

(X) Air Supply Inlet (V) Vent Terminal (■) Area Where Terminal Is Not Permitted

US Installations

- A.** 12 in (30 cm) min. clearance above grade, veranda, porch, deck, balcony, or maximum anticipated snow level.
- B.** 12 in. (30 cm) min. clearance on top or 4 ft. clearance below or to the side of door or window that may be open.
- C.** Clearance to permanently closed window.**
- D.** 12 in (30 cm) min. vertical clearance to ventilated soffit located above the terminal within a horizontal distance of 2 ft (61 cm) from the center line of the terminal.
- E.** 12 in (30 cm) min. clearance to unventilated soffit.
- F.** Clearance to outside corner. **
- G.** 2 ft (61 cm) clearance to inside corner formed by two exterior walls.
- H.** 4 ft (122 cm) clearance to each side of center line extending above meter/regulator assembly.
- I.** 4 ft (122 cm) clearance to service regulator vent outlet.
- J.** 12 in (30 cm) clearance on top or 4 ft (122 cm) clearance below or to the side of nonmechanical air supply inlet to building or the combustion air inlet to any other appliance.
- K.** 3 ft (91 cm) above if within 10 ft (3 m) horizontally of mechanical air supply inlet.

**Clearance in accordance with local installation codes and the requirements of the gas supplier.

OUTLET VENT TERMINATIONS

Standard Horizontal Termination

The standard horizontal exhaust outlet termination is a 2 inch or 3 inch pipe which terminates 12 inches from the outside wall (see figure 10). To prevent potential condensate from collecting in the venting system slope the vent at a downward pitch of 1/8" per 5ft. away from the water heater.

Install the correct size coupling at the outside wall on the exhaust to prevent the termination from being pushed inward.

NOTE: A rodent screen is available through the Parts Department for installations where animals may be able to access the vent system.

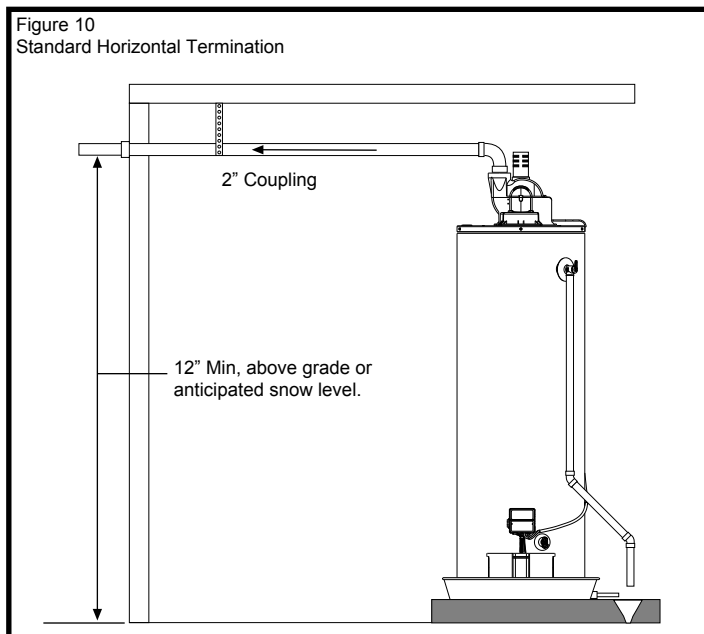

Vertical Termination

The vertical exhaust outlet requires a return bend or two medium or long sweep radius 90° elbows to keep the exhaust outlet downward and prevent entry of rain. Do not include these elbows when calculating the maximum allowable vent pipe because they have already been considered in the vent tables. The vertical exhaust outlet termination is a 2 inch or 3 inch pipe which must be at least 12 inches above the roof line or anticipated snow levels. See figure 11.

NOTE: A rodent screen is available through the Parts Department for installations where animals may be able to access the vent system.

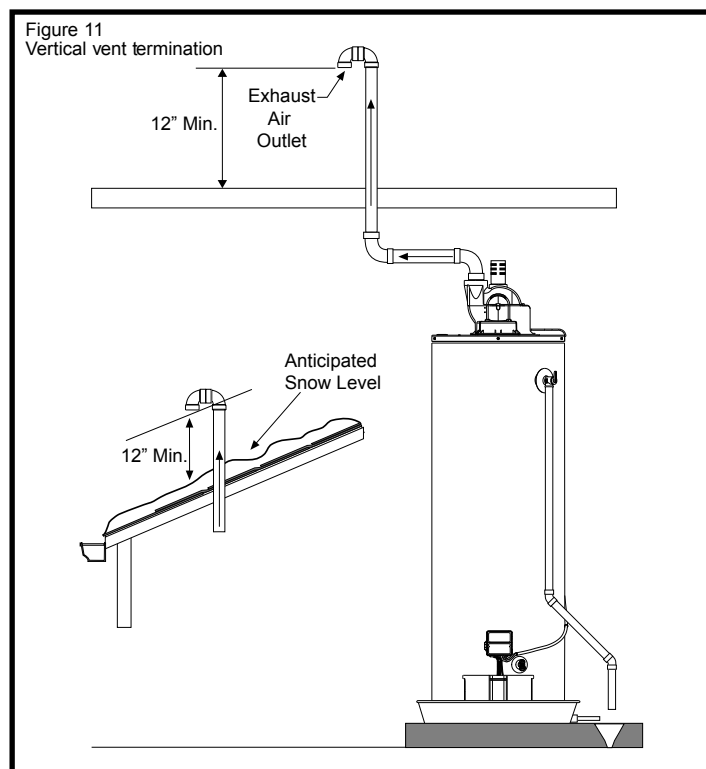

WATER SYSTEM PIPING

Piping Installation

Piping, fittings, and valves should be installed according to the installation drawing (Figure 12). If the indoor installation area is subject to freezing temperatures, the water piping must be protected by insulation.

Water supply pressure should not exceed 80psi. If this occurs a pressure limiting valve with a bypass may need to be installed in the cold water inlet line. This should be placed on the supply to the entire house in order to maintain equal hot and cold water pressures.

IMPORTANT: Heat cannot be applied to the water fittings on the heater as they may contain nonmetallic parts. If solder connections are used, solder the pipe to the adapter before attaching the adapter to the hot and cold water fittings.

IMPORTANT: Always use a good grade of joint compound and be certain that all fittings are drawn up tight.

1. Install the water piping and fittings as shown in Figure 12. Connect the cold water supply (3/4" NPT) to the fitting marked "C". Connect the hot water supply (3/4" NPT) to the fitting marked "H". **IMPORTANT:** Some models may contain energy saving heat traps to prevent the circulation of hot water within the pipes. Do not remove the inserts within the heat traps.
2. The installation of unions in both the hot and cold water supply lines is recommended for ease of removing the water heater for service or replacement.
3. The manufacturer of this water heater recommends installing a tempering valve or an anti-scald device in the domestic hot water line as shown in Figure 13. These valves reduce the point of use temperature of the water by mixing cold and hot water and are readily available for use. Point of use devices for reducing scald hazards that attach to faucets and shower heads are also available from plumbing supply houses. Contact a licensed plumber or the local plumbing authority.
4. If installing the water heater in a closed water system, install an expansion tank in the cold water line as specified under "Closed System/Thermal Expansion".
5. Install a shut-off valve in the cold water inlet line. It should be located close to the water heater and be easily accessible. Know the location of this valve and how to shut off the water to the heater.
6. A temperature and pressure relief valve must be installed in the opening marked "Temperature and Pressure (T & P) Relief Valve" on the water heater. Add a discharge line to the opening of the T & P relief valve. Follow the instructions under Temperature and Pressure Relief Valve".

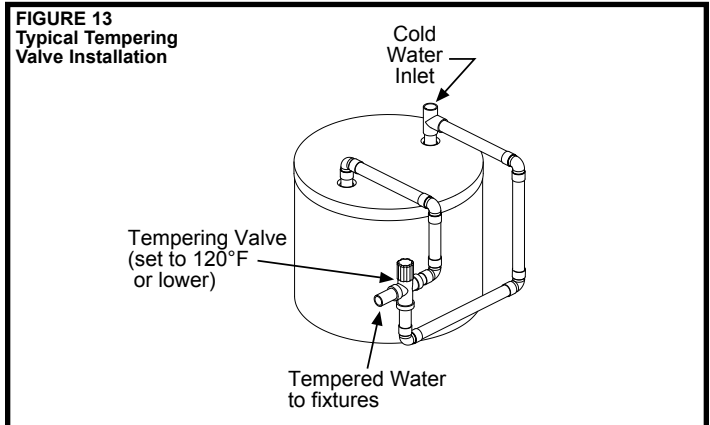
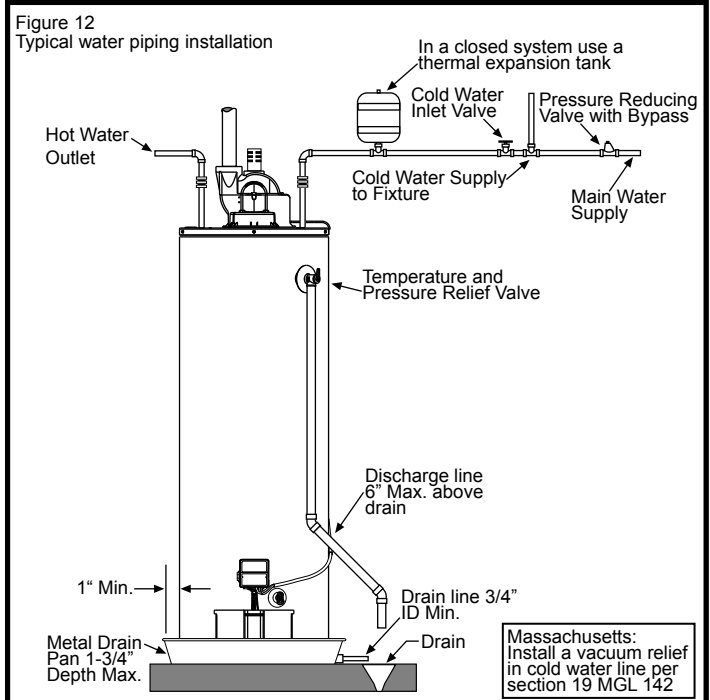

Please note the following:

- The system should be installed only with piping that is suitable for potable (drinkable) water such as copper, CPVC, or polybutylene. This water heater must not be installed using iron piping or PVC water piping.
- Use only pumps, valves, or fittings that are compatible with potable water.
- Use only full flow ball or gate valves. The use of valves that may cause excessive restriction to water flow is not recommended.
- Use only 95/5 tin-antimony or other equivalent solder. Any lead based solder must not be used.
- Piping that has been treated with chromates, boiler seal, or other chemicals must not be used.
- Chemicals that may contaminate the potable water supply must not be added to the piping system.

Closed System/Thermal Expansion

CAUTION - PROPERTY DAMAGE HAZARD

Periodic discharge of the temperature and pressure relief valve may be due to thermal expansion in a closed water supply system. The water utility supply meter may contain a check valve, backflow preventer or water pressure reducing valve. This will create a closed water system. During the heating cycle of the water heater, the water expands causing pressure inside the water heater to increase. This may cause the temperature and pressure relief valve to discharge small quantities of hot water. This is an unacceptable condition and must be corrected. To prevent this, it is recommended that a diaphragm-type expansion tank (suitable for potable water) be installed on the cold water supply line. The expansion tank must have a minimum capacity of 1.5 U.S. gallons for every 50 gallons of stored water. Contact the local water supplier or plumbing inspector for information on other methods to control this situation.

Temperature and Pressure Relief Valve

⚠ WARNING



Explosion Hazard

If the temperature and pressure relief valve is dripping or leaking, have a qualified person replace it.

Examples of a qualified person include: licensed plumbers, authorized gas company personnel, and authorized service personnel.

Do not plug valve.

Do not remove valve.

Failure to follow these instructions can result in death, or explosion.

For protection against excessive pressures and temperatures, a temperature and pressure relief valve must be installed in the opening marked "T & P RELIEF VALVE" (see Figure 14A.) This valve must be design certified by a nationally recognized testing laboratory that maintains periodic inspection of the production of listed equipment or materials as meeting the requirements for Relief Valves for Hot Water Supply Systems, ANSI Z21.22. The function of the temperature and pressure relief valve is to discharge water in large quantities in the event of excessive temperature or pressure developing in the water heater. The valve's relief pressure must not exceed the working pressure of the water heater as stated on the data plate.

IMPORTANT: Only a new temperature and pressure relief valve should be used with your water heater. Do not use an old or existing valve as it may be damaged or not adequate for the working pressure of the new water heater. Do not place any valve between the relief valve and the tank.

Figure 14A
Temperature and Pressure
Relief Valve Installation

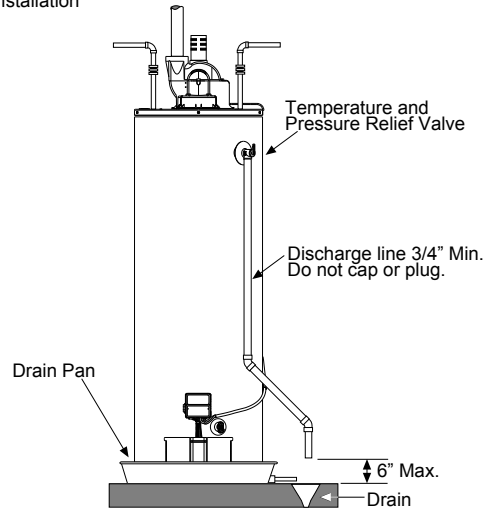

T&P Valve and Pipe Insulation (Some Models)

1. Locate the T&P Valve on the water heater.
2. Locate the slit running the length of the insulation.
3. Spread this slit open and slip it over the T&P Valve. See Figure 14B. Apply gentle pressure to the insulation to ensure it is fully seated on the T&P Valve. Once sealed secure the insulation with a section of tape.
IMPORTANT: The insulation or tape should not block or cover the T&P drain opening. Also the insulation or tape should not block or hinder access to the T&P valve manual relief lever.
4. Next locate the hot water (outlet) & cold water (inlet) pipes to the water heater.
5. Select one of the sections of pipe insulation and locate the slit that runs the length of the insulation.
6. Spread the slit open at the base of the insulation and slip it over the cold water (inlet) pipe. Apply gentle pressure along the length of the insulation to ensure it is fully seated around the cold water pipe. Also ensure that the base of insulation is flush with the water heater. Once seated secure the insulation with a section of tape.
7. Repeat steps 5 through 6 for the hot water (outlet) pipe.

Figure 14B
T&P Valve Insulation

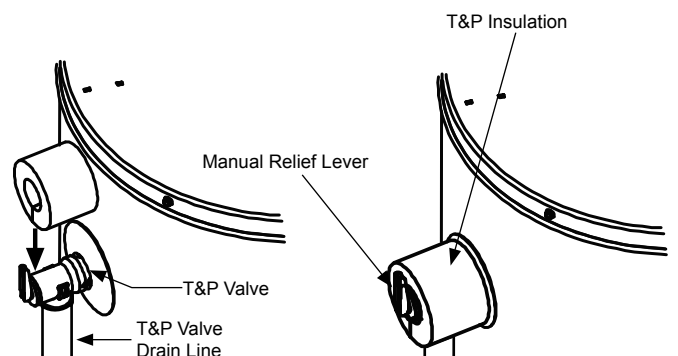

The Temperature and Pressure Relief Valve:

- Shall not be in contact with any electrical part.
- Shall be connected to an adequate discharge line.
- Shall not be rated higher than the working pressure shown on the data plate of the water heater.

The Discharge Line:

- Shall not be smaller than the pipe size of the relief valve or have any reducing coupling installed in the discharge line.

- Shall not be capped, blocked, plugged or contain any valve between the relief valve and the end of the discharge line.
- Shall terminate a maximum of six inches above a floor drain or external to the building.
- Shall be capable of withstanding 250°F (121°C) without distortion.
- Shall be installed to allow complete drainage of both the valve and discharge line.

ELECTRICAL CONNECTIONS

⚠ WARNING



Electric Shock Hazard

Disconnect power before servicing.

Replace all parts and panels before operating.

Failure to do so can result in death or electrical shock.

IMPORTANT: Do not use an extension cord to connect the water heater to an electrical outlet.

- The water heater and the outlet are properly grounded.
- Installed in accordance with prevailing provisions of local codes, or in the absence of such, National Electric Code, ANSI/NFPA 70.

NOTE: Always reference the wiring diagram for the correct electrical connections.

After making all electrical connections, completely fill the tank with water and check all connections for leaks. Open the nearest hot water faucet and let it run for 3 minutes to purge the water lines of air and sediment and to ensure complete filling of the tank. The electrical power may then be turned on. Verify proper operation after servicing.

Before plugging in the water heater, always make sure:

- The voltage and frequency correspond to that specified on the water heater wiring diagram.
- The electrical outlet has the proper overload fuse or breaker protection.

WIRING DIAGRAM

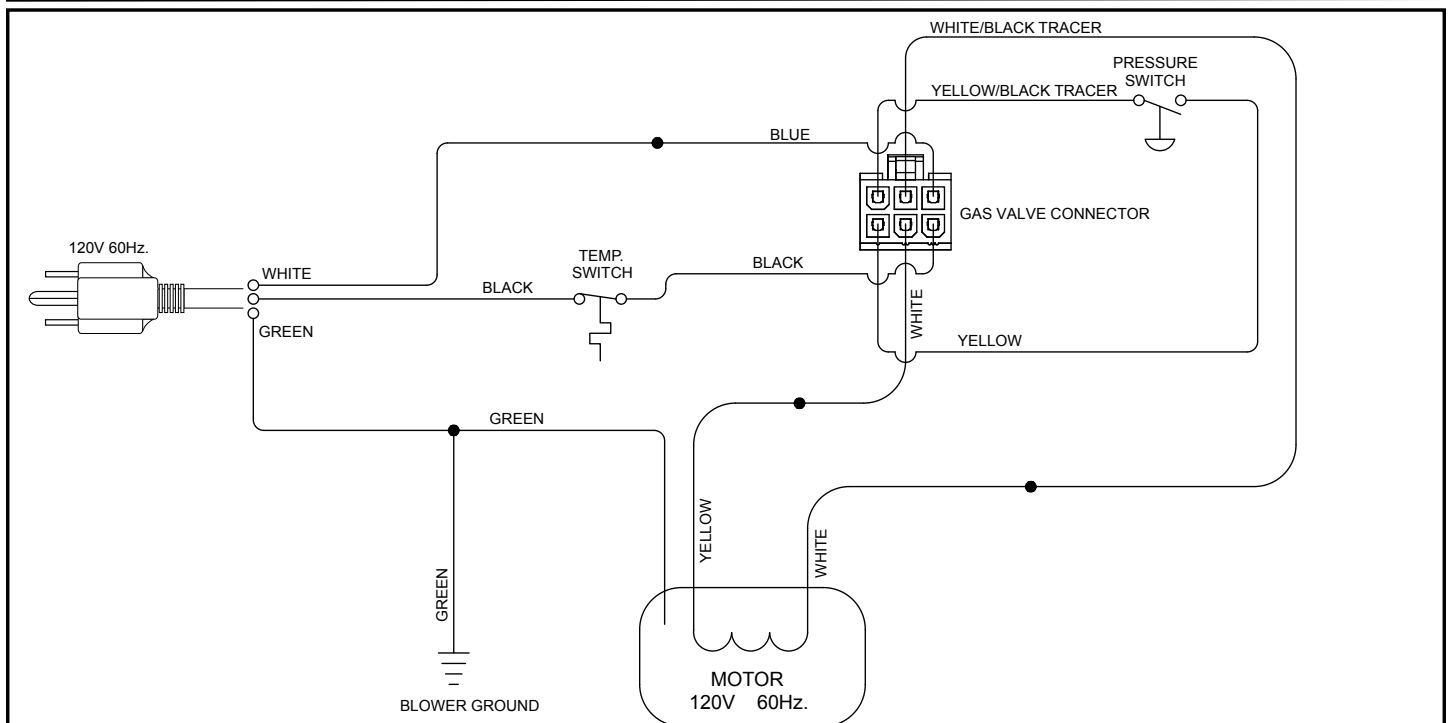

NOTICE:
IF ANY OF THE ORIGINAL WIRES AS SUPPLIED WITH THE APPLIANCE MUST BE REPLACED, IT MUST BE REPLACED WITH 18 GA. STRANDED COPPER 105° C WIRE OR EQUIVALENT. ELECTRICAL RATING 115 VAC, 60 HZ, LESS THAN 5 AMPS.

CAUTION:
LABEL ALL WIRES PRIOR TO DISCONNECTION WHEN SERVICING CONTROLS. WIRING ERRORS CAN CAUSE IMPROPER AND DANGEROUS OPERATION. VERIFY PROPER OPERATION AFTER SERVICING.

INSTALLATION CHECKLIST

Water Heater Location

- Centrally located with the water piping system. Located as close to the gas piping and vent pipe system as possible.
- Located indoors and in a vertical position. Protected from freezing temperatures.
- Proper clearances from combustible surfaces maintained and not installed directly on a carpeted floor.
- Provisions made to protect the area from water damage. Drain pan installed and piped to an adequate drain.
- Installation area free of corrosive elements and flammable materials.
- Sufficient room to service the water heater.
- Water heater not located near an air-moving device.

Gas Supply and Piping

- Gas supply is the same type as listed on the water heater data plate.
- Gas line equipped with shut-off valve, union, and drip leg.
- Approved pipe joint compound used.
- Adequate pipe size and of approved material.
- Chloride-free soap and water solution or other approved means used to check all connections and fittings for possible gas leaks.

Combustion Air Supply/Vent Pipe System

- Sufficient fresh air supply for proper water heater operation.
- Fresh air not taken from areas that contain negative pressure producing devices such as exhaust fans, fireplaces, etc.
- Fresh air supply free of corrosive elements and flammable vapors.
- Fresh air openings sized correctly with consideration given to the blocking effect of louvers and grilles.
- Ductwork is the same cross-sectional area as the openings.
- Vent pipe and fittings of approved material.

- Acceptable size, length, and number of elbows on exhaust outlet pipe.
- Installed in accordance with prevailing provisions of local codes, or in the absence of such, National Fuel Gas Code, NFPA 54, ANSI Z223.1-Current edition.
- Slope 2" & 3" horizontal piping at a downward pitch of 1/8" per 5ft. away from the water heater.
- Not obstructed in any way.

Vent Termination

Horizontal

- 12" Min. above grade/snow level.
- Slope 2" & 3" horizontal piping at a downward pitch of 1/8" per 5ft. away from the water heater.
- Away from corners, other vents, windows, etc.

Vertical

- Outlet - 12" Min. above roof/snow level.

Water System Piping

- Temperature and pressure relief valve properly installed with a discharge line run to an open drain and protected from freezing.
- All piping properly installed and free of leaks.
- Heater completely filled with water.
- Closed system pressure build-up precautions installed.
- Tempering valve installed per manufacturer's instructions.

Electrical Connections

- Unit connected to a dedicated power supply.
- Unit connected to a 120V electrical supply.
- Proper polarity.
- Water heater properly grounded.
- Installed in accordance with prevailing provisions of local codes, or in the absence of such, the current edition of the National Electric Code, ANSI/NFPA 70.

OPERATING YOUR WATER HEATER

Lighting Instructions

Read and understand these directions thoroughly before attempting to operate the water heater. Make sure the tank is completely filled with water before operating the water heater. Check the data plate near the gas control valve/thermostat for the correct gas. Do not use this water heater with any gas other than the one listed on the data plate. If you have any questions or doubts, consult your gas supplier or gas utility company.

⚠ WARNING



Explosion Hazard

Replace viewport if glass is missing or damaged.

Failure to do so can result in death, explosion or fire.

FOR YOUR SAFETY READ BEFORE LIGHTING

WARNING: If you do not follow these instructions exactly, a fire or explosion may result causing property damage, personal injury or loss of life.

- A. This appliance does not have a pilot. It is equipped with an ignition device which automatically lights the burner. Do not try to light the burner by hand.
 - B. **BEFORE LIGHTING** smell all around the appliance area for gas. Be sure to smell next to the floor because some gas is heavier than air and will settle on the floor.
- WHAT TO DO IF YOU SMELL GAS:**
- Do not try to light any appliance.
 - Do not touch any electrical switch; do not use any phone in your building.
 - Immediately call your gas supplier from a neighbor's phone. Follow the gas supplier's instructions.
 - If you cannot reach your gas supplier, call the fire department.
- C. Do not use this appliance if any part has been under water. Immediately call a qualified service technician to inspect the appliance. Water heaters subjected to flood conditions or anytime the gas controls, main burner or pilot have been submerged in water require replacement of the entire water heater.

OPERATING INSTRUCTIONS

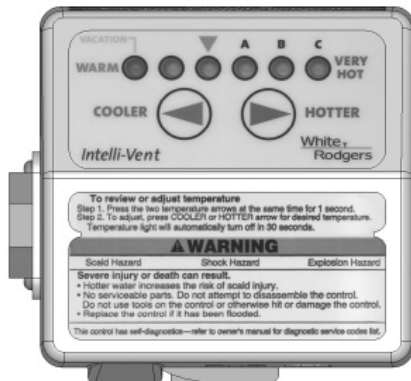

1. **STOP!** Read the safety information above on this label.
2. Connect to a grounded 110/120 volt power supply.
3. Set the thermostat to the lowest setting by first pressing the COOLER (◀) and HOTTER (▶) buttons together and holding for 1 second. Then press the COOLER (◀) button until the WARM indicator light appears.
4. This appliance is equipped with a device which automatically lights the burner.
DO NOT TRY TO LIGHT THE BURNER BY HAND.
5. Wait five minutes to clear out any gas. If you then smell gas. **STOP!** Follow the "B" in the safety information above on this label. If you don't smell gas, go to the next step.
6. Set the thermostat to the desired setting by first pressing the COOLER (◀) and HOTTER (▶) buttons together and holding for 1 second. Then press the HOTTER (▶) button.
7. **WATER TEMPERATURE ADJUSTMENT ▼** is approximately 120°F.
CAUTION: Hotter water increases the risk of scald injury. Consult the instruction manual before changing the temperature.
8. If the appliance will not operate, follow the instructions "TO TURN OFF GAS APPLIANCE" and call a qualified person or gas supplier.
WARNING: TURN OFF ALL ELECTRICAL POWER BEFORE SERVICING.

TO TURN OFF GAS TO APPLIANCE

1. Set the thermostat to the lowest setting by first pressing the COOLER (◀) and HOTTER (▶) buttons together and holding for 1 second. Then press the COOLER (◀) button until the WARM indicator light appears.
2. Unplug electrical service to the appliance if service is to be performed.

L.P.G. (Bottled Propane) Models

Liquefied petroleum gas is over 50% heavier than air and in the occurrence of a leak in the system, the gas will settle at floor level. Basements, crawl spaces, skirted areas under mobile homes (even when ventilated), closets and areas below ground level will serve as pockets for the accumulation of gas. Before lighting an L.P. gas water heater, smell all around the appliance at floor level. If you smell gas, follow the instructions as given in the warning on the front page.

When your L.P. tank runs out of fuel, turn off the gas at all gas appliances including pilot lights. After the tank is refilled, all appliances must be re-lit according to their manufacturer's instructions.

Water Heater Operation

Figure 15 below shows the water heater's sequence of operation when a call for heat is initiated. The ignition control module will attempt to light the burner three times. If the ignition control does not detect ignition it will enter lock-out mode, indicated by a three flash error code.

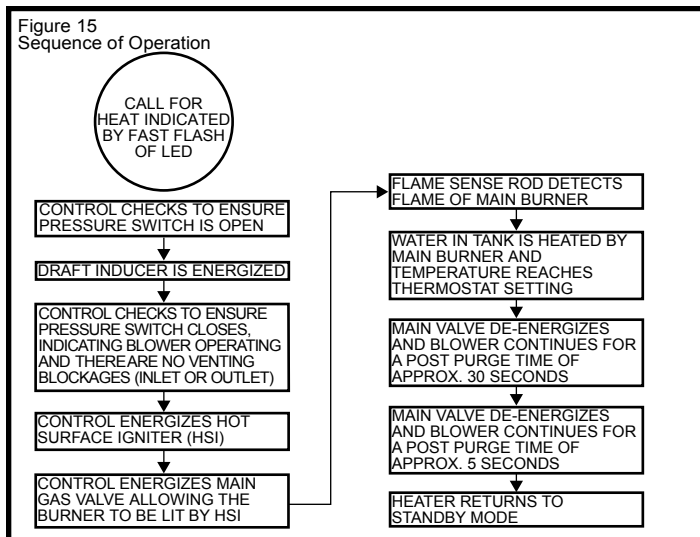

Burner Flames

Inspect the burner flames through the viewport and compare them to the drawings in Figure 16. A properly operating burner should produce a soft blue flame. Blue tips with yellow inner cones are satisfactory. The tips of the flame may have a slight yellow tint. The flame should not be all yellow or have a sharp blue-orange color.

Contaminated air may cause an orange colored flame. Contact a qualified person if the flame is not satisfactory.

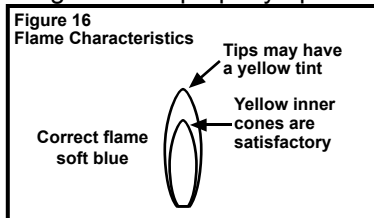

Water Temperature Regulation

Due to the nature of the typical gas water heater, the water temperature in certain situations may vary up to 30°F (16.7°C) higher or lower at the point of use such as, bathtubs, showers, sink, etc.

HOTTER WATER CAN SCALD: Water heaters are intended to produce hot water. Water heated to a temperature which will satisfy space heating, clothes washing, dish washing, and other sanitizing needs can scald and permanently injure you upon contact. Some people are more likely to be permanently injured by hot water than others. These include the elderly, children, the infirm, or physically/mentally handicapped. If anyone using hot water in your home fits into one of these groups or if there is a local code or state law requiring a certain

⚠ WARNING

Water temperature over 125°F can cause severe burns instantly or death from scalds.

Children, disabled and elderly are at highest risk of being scalded.

Feel water before bathing or showering.

Temperature limiting valves are available.

temperature water at the hot water tap, then you must take special precautions. In addition to using the lowest possible temperature setting that satisfies your hot water needs, a means such as a mixing valve, should be used at the hot water taps used by these people or at the water heater. Mixing valves are available at plumbing supply or hardware stores, see Figure 13. Follow manufacturer's instructions for installation of the valves. Before changing the factory setting on the thermostat see Figure 17 and the table below. Using the lowest hot water temperature that meets your needs will also provide the most energy efficient operation of the water heater.

Never allow small children to use a hot water tap, or to draw their own bath water. Never leave a child or handicapped person unattended in a bathtub or shower.

| Temperature Settings | Time to Produce 2nd & 3rd Degree Burns on Adult Skin |
|----------------------|--|
| 160°F (71°C) | About 1/2 second |
| 150°F (66°C) | About 1-1/2 seconds |
| 140°F (60°C) | Less than 5 seconds |
| 130°F (54°C) | About 30 seconds |
| 120°F (49°C) | More than 5 minutes |
| 80°F (27°C) | ----- |

NOTE: A water temperature range of 120°F-140°F (49°C-60°C) is recommended by most dishwasher manufacturers.

The thermostat of this water heater has been factory set at its lowest position, to reduce the risk of scald injury. It is adjustable and must be reset to the desired temperature setting.

The mark (▼) (on temperature setting of gas control valve/thermostat) indicative of approximately 120°F is preferred starting point. Some states have a requirement for a lower setting. If you need hotter water, follow directions for temperature adjustment, but beware of the warnings in this section.

Pressing the "COOLER" button decreases temperature and pressing the "HOTTER" button increases the temperature.

To avoid any unintentional changes in water temperature settings, the control has a tamper resistant feature for changing the temperature setting. To change the temperature setting follow these instructions:

1. "Wake Up" the temperature indicators by holding down both "COOLER" and "HOTTER" temperature adjustment buttons at the same time for one second (See Figure 17). One or two of the temperature indicators will light up. These indicators will only remain on for

30 seconds if no further buttons are pressed. After 30 seconds the control will go back to "Sleep" mode.

2. Release both of the temperature adjustment buttons.
 - A. To decrease the temperature press and release the "COOLER" button until the desired setting is reached.
 - B. To increase the temperature press and release the "HOTTER" button until the desired setting is reached.

NOTE: Holding down the button will not continue to lower or raise the temperature setting. The button must be pressed and released for each temperature change desired.

Should overheating occur or the gas supply fail to shut off, turn off the manual gas control valve to the appliance.

NOTE: During low demand periods when hot water is not being used, a lower thermostat setting will reduce energy losses and may satisfy your normal hot water needs. If hot water use is expected to be more than normal, a higher thermostat setting may be required to meet the increased demand. When leaving your home for extended periods (vacations, etc.) turn the temperature dial to its lowest setting. This will maintain the water at low temperatures with minimum energy losses and prevent the tank from freezing during cold weather.

Figure 17
Gas Valve/□
Thermostat Settings

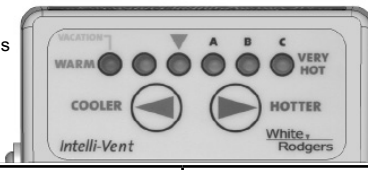

| Temperature Setting | Display ▼ A B C |
|------------------------------|--------------------|
| C - Flashing = approx. 160°F | ○ ○ ○ ○ ● |
| C = approx. 150°F | ○ ○ ○ ○ ● |
| B = approx. 140°F | ○ ○ ○ ● ○ |
| A = approx. 130°F | ○ ○ ○ ● ○ |
| ▼ = approx. 120°F | ○ ○ ● ○ ○ |
| WARM = approx. 80°F | ● ○ ○ ○ ○ |

Operational Conditions

Condensation

Moisture from the products of combustion condenses on the tank surface and the outside jacket of the water heater and forms drops of water which may fall onto the burner or other hot surfaces. This will produce a "sizzling" or "frying" noise. This condensation is normal and should not be confused with a leaking tank. Condensation may increase or decrease at different times of the year.

High efficient energy saver water heaters will produce larger amounts of condensation on initial start-up or when a large amount of hot water is being used. Do not confuse this with a "tank leak". Once the water reaches a temperature of 120°F (49°C) and the tank warms up (usually 1-2 hours), the condensation will stop.

CAUTION - PROPERTY DAMAGE HAZARD

IMPORTANT: It is always recommended that a suitable metal drain pan be installed under the water heater to protect the area from water damage resulting from normal condensation production, a leaking tank or piping connections. Refer to "Location Requirements" section

Water Heater Sounds

During the normal operation of the water heater, sounds or noises may be heard. These noises are common and may result from the following:

1. Normal expansion and contraction of metal parts during periods of heat-up and cool-down.
2. Condensation causes sizzling and popping within the burner area and should be considered normal.
3. Sediment buildup in the tank bottom will create varying amounts of noise and may cause premature tank failure. Drain and flush the tank as directed under "Draining and Flushing".

Smoke/Odor

The water heater may give off a small amount of smoke and odor during the initial start-up of the unit. This is due to the burning off of oil from metal parts of a new unit and will disappear after a few minutes of operation.

Safety Shut-off

This water heater is designed to automatically shut-off in the event of the following:

1. The water temperature exceeds 180°F (83°C.)
 2. A blockage occurs in the combustion chamber air inlet, the flue gas exhaust outlet, or both the inlet and outlet.
 3. The blower fails to operate or operates improperly.
- A high temperature limit switch or ECO (Energy Cut Off) in the tank is used to shut off the unit if the water temperature exceeds 180°F (83°C.) The ECO is a single use switch and requires complete replacement of the entire thermostat. If the ECO should actuate, the water heater cannot be used until the thermostat is replaced by a qualified person. Contact your local dealer for service information.

Anode Rod/Water Odor

Each water heater contains at least one anode rod, which will slowly deplete while protecting the glass-lined tank from corrosion and prolonging the life of the water heater. Once the anode is depleted, the tank will start to corrode, eventually developing a leak. Certain water conditions will cause a reaction between this rod and the water. The most common complaint associated with the anode rod is a "rotten egg smell" produced from the presence of hydrogen sulfide gas dissolved in the water. **IMPORTANT:** Do not remove this rod permanently as it will void any warranties. The parts list includes a special anode that can be ordered if water odor or discoloration occurs. **NOTE:** This rod may reduce but not eliminate water odor problems. The water supply system may require special aeration or chlorination equipment from a water conditioning company to successfully eliminate all water odor problems.

The use of a water softener may decrease the life of the water heater tank.

The anode rod should be removed from the water heater tank every 3 years for inspection. The following are typical (but not all) signs of a depleted anode rod:

- The majority of the rods diameter is less than 3/8".
- Significant sections of the support wire (approx. 1/3 or more of the anode rod's length) are visible.

If the anode rod show signs of either or both it should be replaced. **NOTE:** Whether re-installing or replacing the anode rod, check for any leaks and immediately correct if found.

In replacing the anode:

1. Turn off gas supply to the water heater.
2. Shut off the water supply and open a nearby hot water faucet to depressurize the water tank.
3. Drain approximately 5 gallons of water from tank (Refer to the "Draining and Flushing" section for proper procedures). Close drain valve.
4. Remove old anode rod.
5. Use Teflon® tape or approved pipe sealant on threads and install new anode rod.
6. Turn on water supply and open nearby hot water faucet to purge air from water system. Check for any leaks and immediately correct any if found.
7. Restart the water heater as directed under the "Operating Your Water Heater" section. See the "Repair Parts Illustration" section for anode rod location.

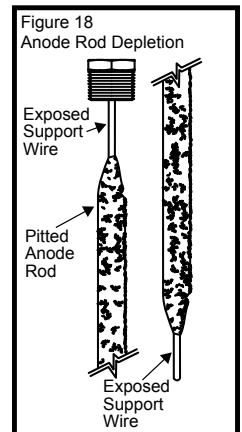

TEFLON® is a registered trademark of E.I. Du Pont De Nemours and Company.

MAINTENANCE OF YOUR WATER HEATER

Draining and Flushing

It is recommended that the tank be drained and flushed every 6 months to remove sediment which may build up during operation. The water heater should be drained if being shut down during freezing temperatures. To drain the tank, perform the following steps:

1. Turn off the gas to the water heater at the manual gas shut-off valve.
2. Turn off the electrical supply to the water heater.
3. Close the cold water inlet valve.
4. Open a nearby hot water faucet.
5. Connect a hose to the drain valve and terminate it to an adequate drain.

NOTE: The drain hose should be rated for at least 200°F (93°C). If the drain hose does not have this rating, open the cold water inlet valve and a nearby hot faucet until the water is no longer hot.

6. Open the water heater drain valve and allow all the water to drain from the tank. Flush the tank with water as needed to remove sediment.
7. Close the drain valve, refill the tank, and restart the heater as directed under "Operating Your Water Heater".

If the water heater is going to be shut down for an extended period, the drain valve should be left open.

IMPORTANT: Condensation may occur when refilling the tank and should not be confused with a tank leak.

Routine Preventive Maintenance

At least annually, a visual inspection should be made of the venting and air supply system, piping systems, main burner, and flame sense/hot surface igniter. Check the water heater for the following:

- Obstructions, damage, or deterioration in the venting system. Make sure the ventilation and combustion air supplies are not obstructed.
- Build up of soot and carbon on the main burner and pilot burner. Check for a soft blue flame.
- Leaking or damaged water and gas piping.
- Presence of flammable or corrosive materials in the installation area.
- Presence of combustible materials near the water heater.
- Verify proper operation after servicing this water heater.

IMPORTANT: If you lack the necessary skills required to properly perform this visual inspection, you should not proceed, but get help from a qualified person.

Temperature and Pressure Relief Valve

⚠ WARNING



Explosion Hazard

If the temperature and pressure relief valve is dripping or leaking, have a qualified person replace it.

Examples of a qualified person include: licensed plumbers, authorized gas company personnel, and authorized service personnel.

Do not plug valve.

Do not remove valve.

Failure to follow these instructions can result in death, or explosion.

Manually operate the temperature and pressure relief valve at least once a year to make sure it is working properly (see Figure 19.) To prevent water damage, the valve must be properly connected

to a discharge line which terminates at an adequate drain. Standing clear of the outlet (discharged water may be hot), slowly lift and release the lever handle on the temperature and pressure relief valve to allow the valve to operate freely and return to its closed position. If the valve fails to completely reset and continues to release water, immediately shut off the manual gas shut-off valve and the cold water inlet valve and call a qualified person.

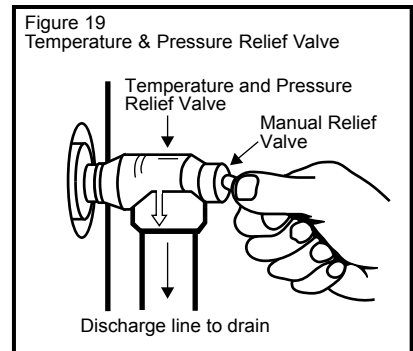

Replacement Parts

Replacement parts may be ordered through your plumber or the local distributor. Parts will be shipped at prevailing prices and billed accordingly. When ordering replacement parts, always have the following information ready:

1. model, serial, and product number
2. type of gas
3. item number
4. parts description

See "Repair Parts" section.

Removing the Burner/Manifold Assembly

1. Turn off the gas to the water heater at the manual gas shut-off valve (See figure 2), and disconnect power to the water heater.
2. Remove the outer door.
3. Remove the 2 screws securing the manifold door assembly to the skirt.
4. Disconnect the hot surface igniter/ flame sense wire and manifold tube at the thermostat. (Figure 20) NOTE: L.P. gas systems use reverse (left-hand) threads on the manifold tube.

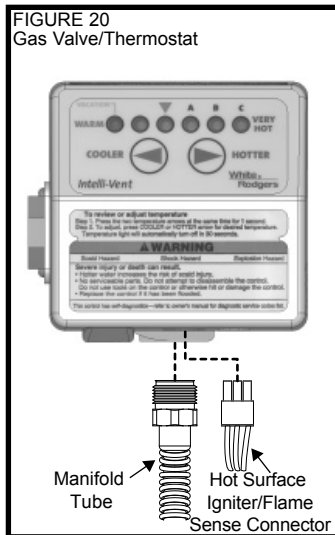

5. Grasp the manifold tube and push down slightly to free the manifold from the gas control valve/ thermostat.
6. Carefully remove the manifold assembly from the burner compartment. Be sure not to damage internal parts.
7. Check the burner to see if it is dirty or clogged. The burner may be cleaned with soap and hot water.

Removing the Burner from the Manifold Assembly

1. Take off the burner by removing the two (2) screws located underneath the burner.
2. Check the burner to see if it is dirty or clogged. The burner may be cleaned with soap and hot water. See Figure 21.

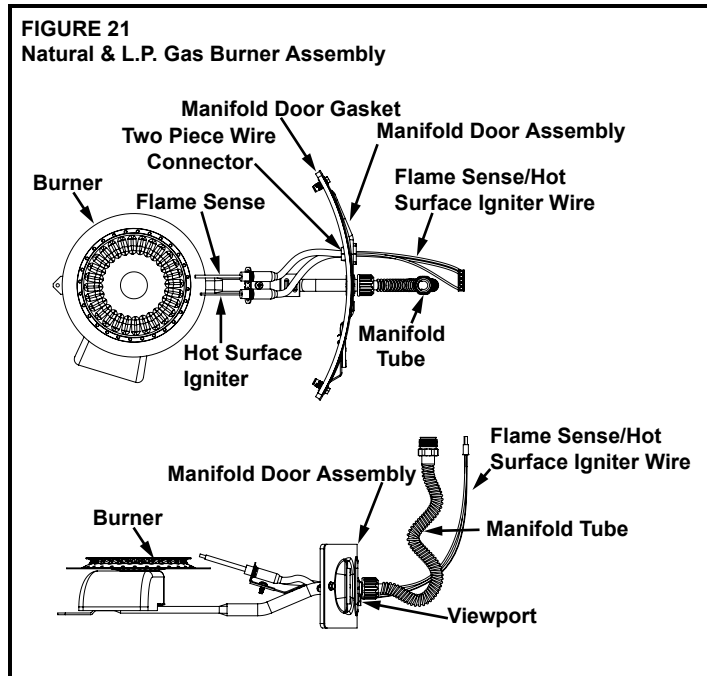

⚠ WARNING



Explosion Hazard

Tighten both manifold door screws securely.

Remove any fiberglass between gasket and combustion chamber.

Replace viewport if glass is missing or damaged.

Replace two piece wire connector if missing or removed.

Replace door gasket if damaged.

Failure to follow these instructions can result in death, explosion, or fire.

Replacing the Manifold Assembly

1. Check the door gasket for damage or imbedded debris prior to installation.
2. Inspect the viewport for damage and replace as required.
3. Insert the manifold assembly into the burner compartment making sure that the manifold tab engages the slot inside the combustion chamber. See Figure 22.

FIGURE 22
Manifold Tab

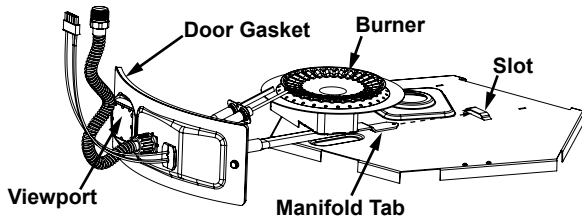

4. Inspect the door gasket and make sure there is no fiberglass insulation between the door gasket and the combustion chamber.
5. Replace the two screws, which secure the manifold assembly door to the combustion chamber and tighten securely. Once the manifold assembly door is tightened, visually inspect the door gasket between the manifold assembly door and the combustion chamber for spaces or gaps that would prevent a seal. **IMPORTANT:** Do not operate the water heater if the door gasket does not create a seal between the manifold door and the combustion chamber.

6. Reconnect the manifold tubing to the thermostat. Do not cross-thread or apply any thread sealant to the manifold tubing.

NOTE: L.P. gas systems use reverse (left-hand) threads on the manifold tube.

7. Reconnect the Flame Sense/Hot Surface Igniter wire to the thermostat.
8. Turn gas supply on and refer to the Lighting Instructions.
9. Check for leaks by brushing on an approved noncorrosive leak detection solution. Bubbles will show a leak. Correct any leak found.
10. Replace the outer door.

Removing and Replacing the Gas Control Valve/Thermostat

IMPORTANT: Use only factory authorized replacement parts.

Removing the Gas Control Valve/Thermostat:

1. Set the gas control valve/thermostat to its lowest setting by first depressing the COOLER ⬅ and HOTTER ➡ buttons together and hold for 1 second. Then press the COOLER ⬅ button until the WARM indicator light appears. (Figure 16).
2. Unplug the water heater from the wall outlet.
3. Turn off the gas at the manual shut-off valve on the gas supply pipe (Figure 2).
4. Drain the water heater. Refer to the “Draining and Flushing” section and follow the procedure.
5. Disconnect the flame sense/hot surface igniter wire from the thermostat. Disconnect the manifold tube at the thermostat (Figure 20). **NOTE:** L.P. gas systems use reverse (left-hand) threads on the manifold tube.
6. Refer to “Gas Piping” (Figure 2) and disconnect the ground joint union in the gas piping. Disconnect the remaining pipe from the gas control valve/thermostat.
7. To remove the gas control valve/thermostat, thread a correctly sized pipe into the inlet and use it to turn the gas control valve/thermostat (counterclockwise.) Do not use pipe wrench or equivalent to grip body. Damage may result, causing leaks. Do not insert any sharp objects into the inlet or outlet connections. Damage to the gas control valve/thermostat may result.













Replacing the Gas Control Valve/Thermostat:

To replace the gas control valve/thermostat, reassemble in reverse order. Use only factory authorized replacement parts.

- Be sure to use approved Teflon[®] tape or pipe joint compound on the gas piping connections and fitting on the back of the gas control valve/thermostat that screws into tank.
- Turn gas supply on and check for leaks. Use a chloride-free soap and water solution (bubbles forming indicate a leak) or other approved method.
- Be sure tank is completely filled with water before lighting and activating the water heater. Follow the Lighting Instructions.
- If additional information is required, contact the Service Department at: 1-800-456-9805.

TEFLON[®] is a registered trademark of E.I. Du Pont De Nemours and Company.

TROUBLESHOOTING

| LED STATUS | PROBLEM | SOLUTION |
|---|--|---|
|  | An open earth ground circuit to the ignition system. | <ol style="list-style-type: none"> 1. Check that the earth ground connection is properly connected. 2. Check that the earth ground conductor on the water heater is properly connected. |
|  | Wiring error or a high resistance to earth ground. | <ol style="list-style-type: none"> 1. Check for proper connection of line neutral and hot wires. 2. Check that the water heater is securely connected to earth ground. |
|  | Pressure switch remained closed longer than 5 seconds after the call for heat began. | <ol style="list-style-type: none"> 1. Pressure switch wiring is incorrect. 2. Replace pressure switch. |
|  | Pressure switch remained open longer than 5 seconds after the combustion blower was energized. | <ol style="list-style-type: none"> 1. Pressure switch wiring is incorrect. 2. Pressure Switch tubing is not connected correctly. 3. Air intake or exhaust obstructed. |
|  | Error in the hot surface igniter circuit. | <ol style="list-style-type: none"> 1. Check that all wiring is correct and secure. 2. Replace hot surface igniter. |
|  | System in lockout. | <ol style="list-style-type: none"> 1. Gas supply is off or too low to operate. 2. Hot surface igniter not positioned correctly. 3. Low voltage to the water heater. 4. Electric polarity to unit is incorrect - test and correct. |
|  | Problem in the gas valve driver circuit. | <ol style="list-style-type: none"> 1. Turn power to the water heater off for 10 seconds and then back on. 2. Replace gas control valve. |
|  | Problem with the internal circuit. | <ol style="list-style-type: none"> 1. Turn power to the water heater off for 10 seconds and then back on. 2. Replace gas control valve. |
|  | Problem with the internal circuit. | <ol style="list-style-type: none"> 1. Turn power to the water heater off for 10 seconds and then back on. 2. Replace gas control valve. |
|  | Flame signal sensed out of proper sequence. | <ol style="list-style-type: none"> 1. Replace gas control valve. |
|  | ECO activated. | <ol style="list-style-type: none"> 1. Replace gas control valve. |
|  | One of the temperature adjust buttons stuck closed. | <ol style="list-style-type: none"> 1. Press and release each of the buttons once. 2. Replace gas control valve. |
|  | Water temperature sensor is either open or short circuited. | <ol style="list-style-type: none"> 1. Check that all wiring is correct and secure. 2. Replace gas control valve. |

TROUBLESHOOTING cont.

| PROBLEM | CAUSE | SOLUTION |
|---|--|---|
| NO HOT WATER | Blower will not run. | |
| | A) Blower unplugged. | Plug blower back into 115 VAC. outlet. |
| | B) No power at outlet. | Repair service to outlet. |
| | C) Thermostat defective. | Replace thermostat. |
| | D) High limit control circuit open. | Replace ECO. |
| | E) Blower motor defective. | Replace Blower Assembly. |
| | F) Pressure switch defective. | Replace Pressure Switch/Blower Assembly. |
| NOT ENOUGH HOT WATER | Thermostat problems. | |
| | A) Thermostat set too low. | Set temperature control higher. |
| | B) Thermostat or ECO defective. | Replace thermostat or ECO as required. |
| | Others | |
| | A) Heater undersized. | Reduce hot water use. |
| | B) Low gas pressure. | Contact dealer. |
| | C) Incoming water is unusually cold. | Allow more time for heater to reheat. |
| | D) Leaking hot water pipes or fixtures. | Have plumber check and repair leaks. |
| VENT PIPE TOO HOT (ABOVE 170°F) | A) Defective air flow restrictor | Take unit out of service immediately, call a qualified person to service the unit. |
| | B) Not enough dilution air to mix with flue gases in inlet elbow. | Proper dilution air must be provided for combustion and dilution of flue temp. See "Combustion Air Supply/Vent Pipe System", section. |
| | C) Dilution air too hot for mixing with flue gases. | Supply air is too hot. Check for heat sources around intake terminal and blockage of dilution air leg. |
| | D) Wrong burner orifice. | Install correct orifice. |
| YELLOW FLAME | A) Dirt in burner ports. | Turn off heater and gas, clean burner head. |
| | B) Combustion air path restricted. | Check intake venting arrangements for obstructions. |
| | C) Not enough dilution air for proper combustion. | Check intake venting arrangements for obstructions. |
| CONDENSATION | A) Water on the floor under heater. | See "OPERATIONAL CONDITIONS", section. |
| | B) Water dripping from blower assembly. | Provide drip "TEE" to catch condensation from horizontal section of exhaust vent close to blower assembly. |
| WATER LEAKS | A) Improperly sealed, hot or cold supply connections, relief valve, drain valve or thermostat threads. | Tighten threaded connections. |
| | B) Leakage from other appliances or water lines. | Inspect other appliances near water heater. |
| | C) Condensation of flue products. | See "OPERATIONAL CONDITIONS", section. |
| LEAKING T&P | A) Thermal expansion in closed water system. | Install thermal expansion tank (DO NOT plug T&P valve). |
| | B) Improperly seated valve. | Check relief valve for proper operation (DO NOT plug T&P valve). |
| HOT WATER ODORS (See ANODE ROD/WATER ODOR, Section) | A) High sulfate or mineral content in water supply. | Drain and flush heater thoroughly then refill. |
| | B) Bacteria in water supply. | Chlorinate water supply. |
| WATER TOO HOT | A) Thermostat set too high. | See "WATER TEMPERATURE REGULATION", section. |
| WATER HEATER SOUNDS SIZZLING-RUMBLING | A) Condensation dripping on burner. | See "OPERATIONAL CONDITIONS", section. |
| | B) Sediment at bottom of heater tank. | See "MAINTENANCE OF YOUR WATER HEATER", section. |
| SOOTING | A) Improper combustion. | See "Combustion Air Supply/Vent Pipe System", section. |
| HEATER LIGHTS BUT GOES OUT IN 4-5 SECONDS | A) Outlet polarity is reversed. | Test polarity and correct. |

REPAIR PARTS ILLUSTRATION

When ordering repair parts always give the following information:

1. Model, serial and product number
2. Type of gas
3. Item number
4. Parts description

Repair Parts List

| Item No. | Parts Description |
|----------|--|
| 1 | Blower |
| 2 | Pressure Switch (Not Pictured) |
| 3 | Flue Baffle |
| 4 | Heat Trap (Cold) |
| 5 | Heat Trap (Hot) |
| 6 | Cold Water Dip Tube |
| 7 | Anode Rod* |
| 8 | Temperature and Pressure Valve |
| 9 | Drain Valve |
| 10 | Gas Control Valve/Thermostat |
| 11 | Hot Surface Igniter (HSI)** |
| 12 | Natural Gas Burner |
| 13 | L.P. Gas Burner** |
| 14 | Manifold Door Assembly - Natural Gas |
| 15 | Manifold Door Assembly - L.P. Gas** |
| 16 | Two Piece Wire Connector w/Retainer Clip** |
| 17 | Manifold Door Gasket** |
| 18 | Viewport Assembly** |
| 19 | Outer Door |

* Special anode rod available, see "Anode Rod/Water Odor" section.

** Pictured on next page.

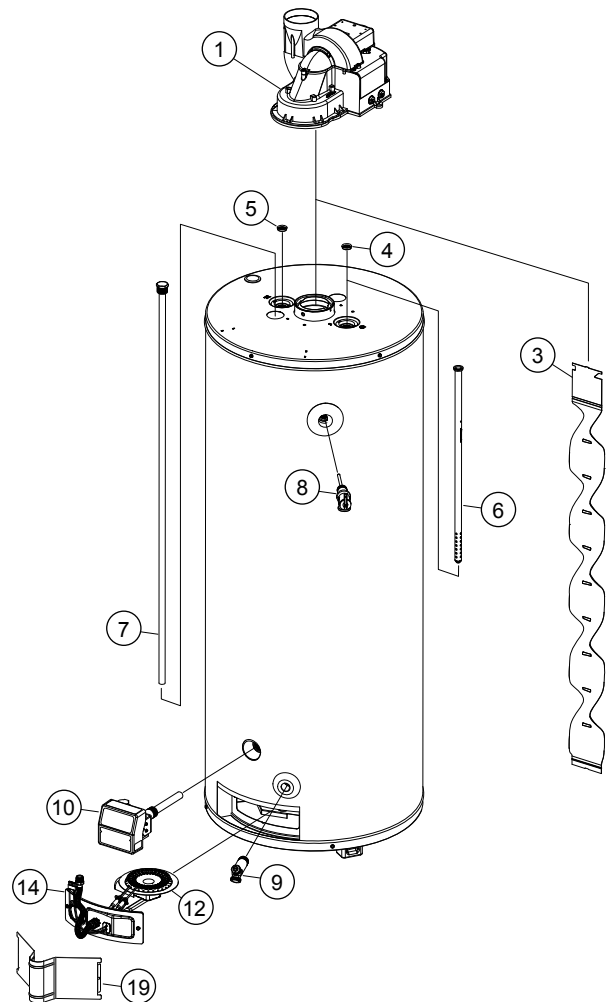

Listed Parts Kits and Illustrations

Item 11: Flame Sense/Hot Surface Igniter Assembly.

Item 12: Burner (Natural Gas)

Item 13: Burner (L.P. Gas)

Item 14: Manifold door assembly which contains the manifold tube, gasket, manifold door, two piece wire connector with retainer clip, and flame sense/hot surface igniter assembly. (Natural Gas)

Item 15: Manifold door assembly which contains the manifold tube, gasket, manifold door, two piece wire connector with retainer clip, and flame sense/hot surface igniter assembly. (L.P. Gas)

Item 16: Contains two piece wire connector with retainer clip.

Item 17: Contains manifold door gasket.

Item 18: Contains viewport.

