

# Actuator Controller & Valve/Pump Switch Applications

## P4043ME Application

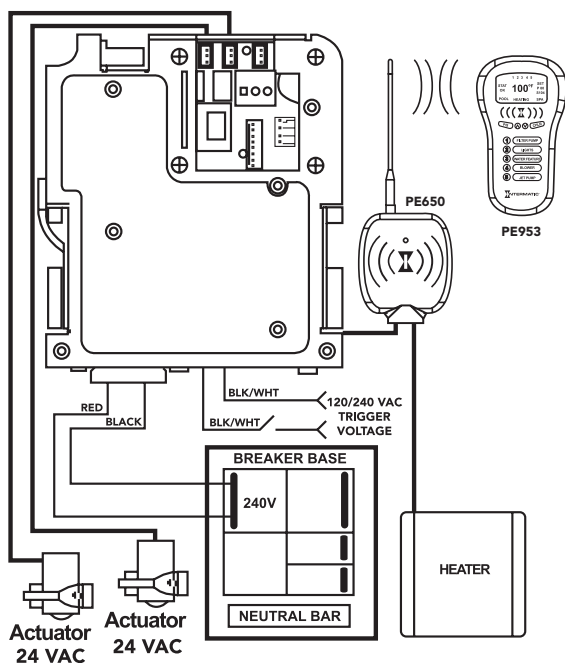

**Applications:** The P4043ME Actuator Control Mechanism gives you an economical way to control up to three valve actuators with either a simple aftermarket switch, a sophisticated PE650/PE953 wireless control or both. In the example, we illustrate controlling two valve actuators most commonly found in a fountain control, solar control or pool/spa control system. This device is also capable of switching a pool/spa thermostat on a remote heater by wiring the remote heaters thermostat pool/common/spa wires to the onboard connector. When a 120 VAC or 240 VAC trigger voltage is transferred through the aftermarket switch to the mechanism's blk/wht wires, the valve actuators and heater thermostat will change to the opposite position, (i.e. pool to spa, pool thermostat to spa thermostat), and back again once the switch is opened. If a wireless PE650/PE953 combination is added to the mechanism, a wireless full thermostat control system along with actuator control would now be available.

## P4243ME Application

### Sensor Line

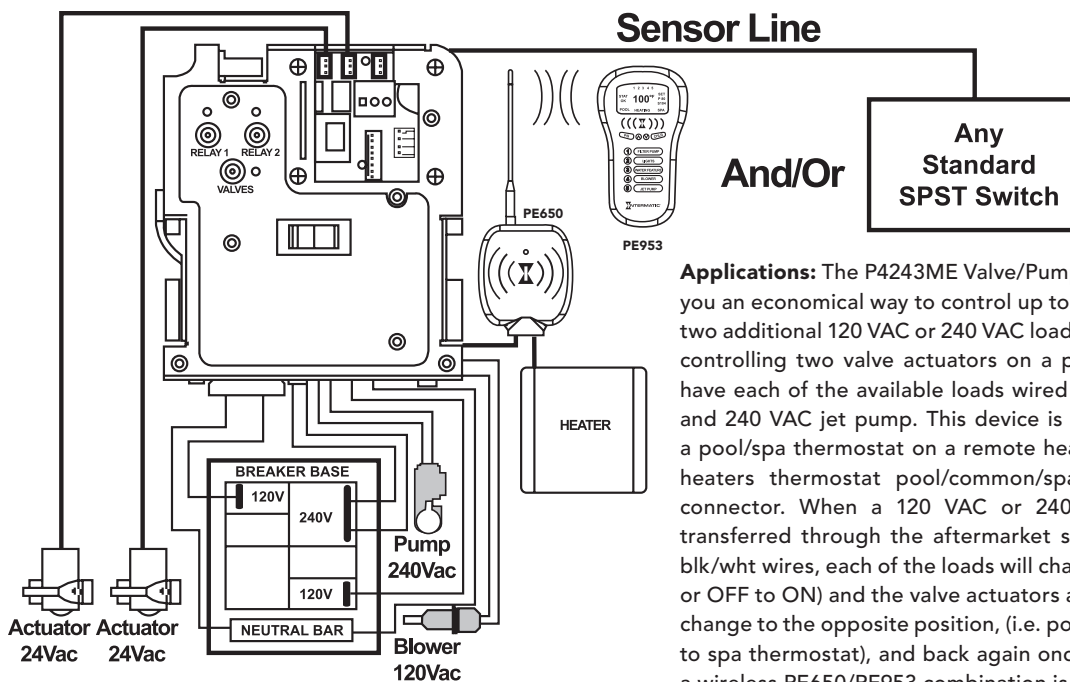

**Applications:** The P4243ME Valve/Pump Switch Mechanism gives you an economical way to control up to three valve actuators and two additional 120 VAC or 240 VAC loads. The example, illustrates controlling two valve actuators on a pool/spa combination and have each of the available loads wired to a 240 VAC spa blower and 240 VAC jet pump. This device is also capable of switching a pool/spa thermostat on a remote heater by wiring the remote heaters thermostat pool/common/spa wires to the onboard connector. When a 120 VAC or 240 VAC trigger voltage is transferred through the aftermarket switch to the mechanisms blk/wht wires, each of the loads will change state, (i.e. ON to OFF or OFF to ON) and the valve actuators and heater thermostat will change to the opposite position, (i.e. pool to spa, pool thermostat to spa thermostat), and back again once the switch is opened. If a wireless PE650/PE953 combination is added to the mechanism, a wireless full thermostat control system along with actuator control and individual load control would now be available.

Section 5:

# Programming the Valve/Pump Switch Mechanism

## Overview of the Valve/Pump Switch Control Panel

### Front View

**ACTUATOR CONNECTION** — The Valve/Pump Switch mechanism supports up to three 24V valve actuators.

**HEATER THERMOSTAT CONNECTOR** — supports the three wires from the heaters thermostat. The wires should be marked Pool, Common, and Spa. The mechanism will switch the heater thermostat when the actuators change.

**SERVICE BUTTONS** — allow you to operate the mechanism at the panel.

**WIRED OR WIRELESS CONNECTOR** will support either the wired remote control or the panel-mounted wireless transceiver.

**POOL/SPA THERMOSTAT SWITCH** — allows you to switch between the pool and spa thermostat or just the spa only. In the spa only mode, the pool thermostat is disabled.

**JUMPER BLOCK CONFIGURATION** — used when a simple single-pole single through switch is going to be used in conjunction with the Sensor Line to control the Pool to Spa Mech. This is the most inexpensive way to achieve total pool/spa automation.

**DUAL-VOLTAGE TRANSFORMER** — is capable of being powered with either 120V or 240V.

**CIRCUITS 1 & 2** — The pool to spa mechanism supports up to two auxiliary 3HP circuit loads. You can have different source voltages for each circuit, depending on your equipment requirements.

**SENSOR LINE** — allows the mechanism to be controlled by a single pole sing throw switch (i.e. toggle switch, relay, wall switch, etc.). See page 38 for details.

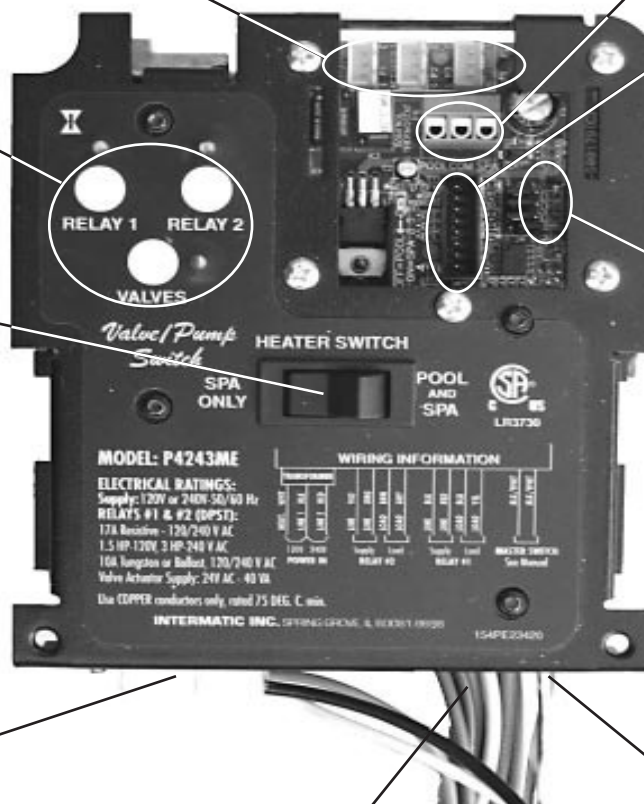

## Rear View

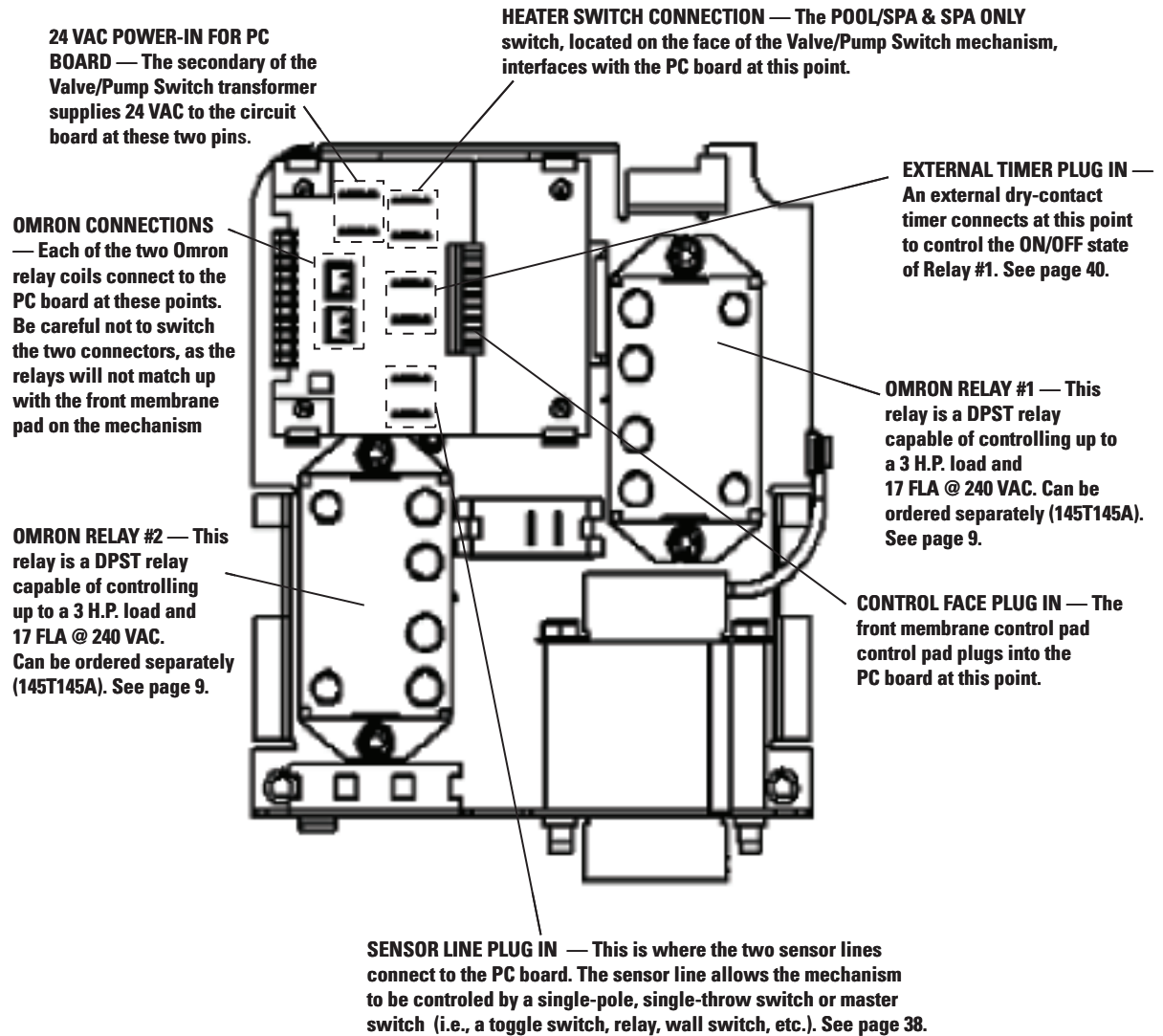

## Installing the Three-Button Wired Remote Control

The Three-Button Wired Remote Control (133PE1484A) can be installed to plug into either the Three-Circuit Clock (P1353ME) or Valve/Pump Switch (P4243ME).

When plugged into one of these mechanisms, it replaces the wireless method of controlling the three circuits within the mechanism. For example, if you plug the Three-Button Wired Remote Control into the Valve/Pump Switch, the two relays and the actuators will no longer be controllable using the Hand-Held Wireless Remote. The Three-Button Wired Remote Control **must** be installed where a third mechanism is needed in the enclosure box, since the Wireless Hand-Held Remote Transceiver can only control two mechanisms.

See illustrations below for connection detail.



**Three-Button Wired Remote Control (133PE1484A)**

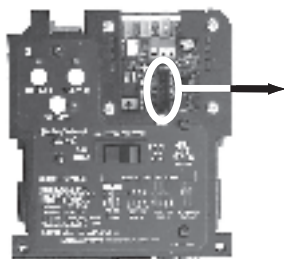

**Connection to Valve/Pump Switch (PE4243ME)**

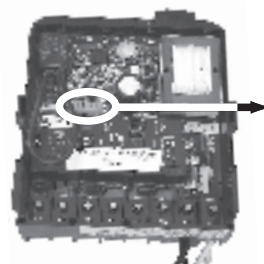

**Connection to Three-Circuit Clock (PE1353ME)**

## Installing Other Wired Remote Connections (Master Switch)

You can install any ON/OFF switch to the sensor line to provide wired control of the two relays and the Pool/Spa actuators in the Valve/Pump Switch (P4243ME), giving you dual control (master switch and wireless) control of these circuits.

***In use, a wired remote switch toggles all circuits to their opposite state.*** This means that if Relays 1 and 2 are ON, and the actuator valve is in SPA, the wired remote switch will turn Relays 1 and 2 OFF, while switching the actuator valve to POOL. It does this by toggling Relays 1 and 2 and the actuator valve back and forth from their default state in order to return the system to its default setting after the owner has made temporary changes to the settings. For example, if using the phone while sitting in the spa, the owner may turn off the jets to reduce noise. The next time the Master Switch is used, the jets will revert to being ON when the system is in spa mode.

---

**INSTALLATION ISSUE:** If you want to change the default state for your installation and you manually press the switches on the Valve/Pump Switch control panel, your changes will be temporary with the wired remote switch (master switch) because it will return the circuits to their factory default setting when it is activated, eliminating your custom settings.

---

Therefore, if you want to make permanent changes to the factory defaults, you must use the jumper, as shown at the right. Then the wired remote switch's return to defaults will not delete your changes.

The jumper rows control the position of the relays as follows:

- J1 = Master Switch
  - Jumper on pins 1 and 2 sets the system default state to a LATCHING Sensor Line. ***This is the factory default state.***
  - Jumper on pins 2 and 3 sets the system default state to MOMENTARY Sensor Line.
- J2 = Relay #1
  - Jumper on pins 1 and 2 sets Relay #1 to OPEN = OFF.
  - Jumper on pins 2 and 3 sets Relay #1 to CLOSED = ON.
- J3 = Relay #2
  - Jumper on pins 1 and 2 sets Relay #2 to OPEN = OFF.
  - Jumper on pins 2 and 3 sets Relay #2 to CLOSED = ON.
- J4 = Not used — for future implementation

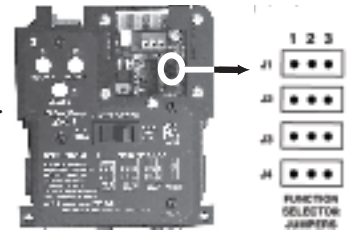

## Connecting the Heater Switch to Control Temperatures

### Overview

The primary means of controlling the heater is using the Hand-Held Controller. If there is no Hand-Held Controller in the system, the heater switch provides an alternate method.

This Switch can be also used in conjunction with the Hand-Held Controller to provide maximum temperature limits for the pool and spa. Control by this Switch is primary over the Hand-Held.

### Procedure

1. Wire the heater thermostats to the blue connectors visible on the front of the Valve/Pump Switch, as shown.
2. Set limits on the heaters themselves, so that when the Switch powers the heaters, they will reach the temperatures you have set.
3. Make temperature adjustments at the heaters themselves.

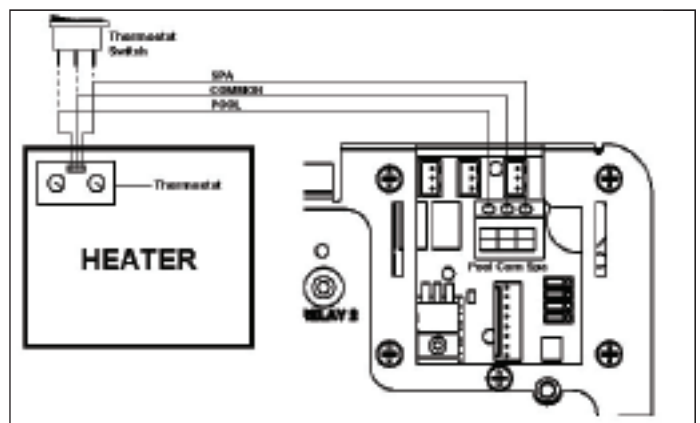
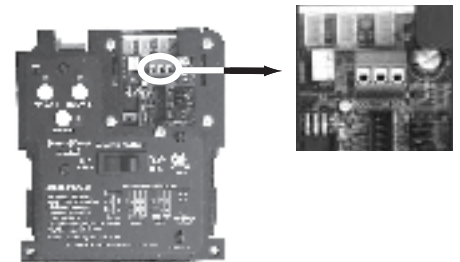

## If Connecting an External Timer:

### Overview

You can add an external timer to a circuit, providing timer control to the “on demand” circuit. External timers are available from Intermatic and are not included with the I-Wave system. When connected to the system, the external timer powers Relay 1 on and off according to its time settings.

### Procedure

Connect your timer to Relay 1 on the back of the Valve/Pump Switch Mechanism, as shown in the circled area of the illustration at the right. An independent contact (Dry Contact) timer is required to be connected to the circuit board 1/4” spade terminals. ***Do not apply voltage to these terminals!***

