



# Solid-State Power OFF-Delay Timer

# H3CR-H

1/16 DIN, Analog-Set Timer with Power-OFF Delay, Four Selectable Ranges

- Extended power OFF-delay timer, up to 12 seconds, for S-type and 12 minutes for M-type models
- Forced resetting type provides a manual override of the timing function
- 11-pin and 8-pin models are available
- Red LED output indicator



## Ordering Information

### ■ TIMERS

Part number	H3CR-H8L		H3CR-H8L		H3CR-H8RL	
Timing function	Power OFF-delay					
Contact type	DPDT				SPDT	
Forced resetting	Available				Available	
Timing units	S-series (seconds)	M-series (minutes)	S-series (seconds)	M-series (minutes)	S-series (seconds)	M-series (minutes)
Terminal form	11-pin models		8-pin models			
Supply voltages	100 to 120 VAC, 200 to 240 VAC, 24 VAC/DC, 100 to 125 VDC					

**Note:** Specify both the supply voltage and time unit code (S or M) in addition to the model number when ordering.

Example: H3CR-H8L 24 VAC/DC M  
└─── Time unit code  
└─── Supply voltage

### ■ MODEL NUMBER LEGEND

H3CR -          
1 2 3 4

#### 1. Classification

H: Power OFF-delay timer

#### 2. Configuration

None: 11-pin socket  
 8: 8-pin socket

#### 3. Input

None: Without reset input  
 R: With reset input

#### 4. Dimensions

L: Long-body model

■ ACCESSORIES (ORDER SEPARATELY)

Description		Part number	
Sockets	11-pin	Bottom surface or track mounting, top screw terminals	P2CF-11
		Bottom surface or track mounting, top screw terminals, finger safe terminal conforms to VDE0106/P100	P2CF-11-E
		Back mounting, for use with Y92F-30 mounting adapter, bottom screw terminals	P3GA-11
	8-pin	Bottom surface or track mounting, top screw terminals	P2CF-08
		Bottom surface or track mounting, top screw terminals, finger safe terminal conforms to VDE0106/P100	P2CF-08-E
		Back mounting, for use with Y92F-30 mounting adapter, bottom screw terminals	P3G-08
Terminal cover for P3G sockets, conforms to VDE0106/P100		Y92A-48G	
Panel mounting adapter	Fits behind panel, ideal for side-by-side installation. Use P3G _ _ sockets		Y92F-30
	Panel-mounting adapter (88 mm x 58 mm x 63.7 mm)		Y92F-70
	Panel-mounting adapter (58 mm x 50 mm x 63.7 mm)		Y92F-71
Protective cover	Hard plastic cover protects against dust, dirt and water (not for use with panel covers)		Y92A-48B
NEMA 4 cover	Waterproof front cover		Y92A-48N
Colored panel covers	Light gray (Munsell No. 5Y7/1) to match case		Y92P-48GL
	Medium gray (Munsell No. 5Y5/1)		Y92P-48GM
	Black (Munsell No. N1.5)		Y92P-48GB
Time setting rings	Used to lock-in a single setting; one ring, can be used with Y92P panel covers		Y92S-27
	Used to lock-in a setting range; two rings, can be used with Y92P panel covers		Y92S-28
Mounting track	DIN rail, 50 cm (1.64 ft) length; 7.3 mm thick		PFP-50N
	DIN rail, 1 m (3.28 ft) length; 7.3 mm thick		PFP-100N
	DIN rail, 1 m (3.28 ft) length; 16 mm thick		PFP-100N2
End plate			PFP-M
Spacer			PFP-S

■ RANGE SELECTION

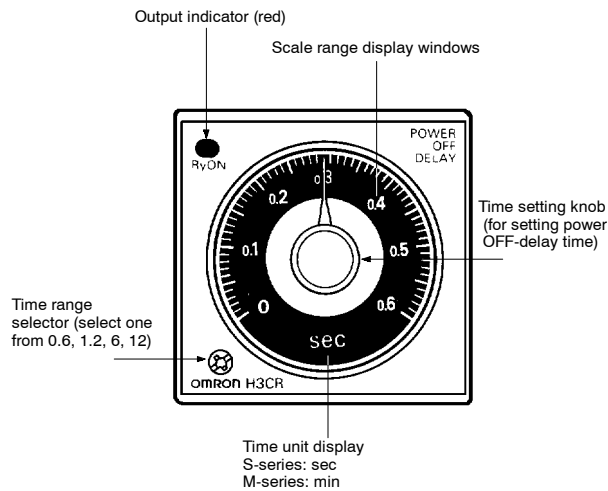

Time range	S-series	M-series
	seconds	minutes
Setting	0.6	0.05 to 0.6
	1.2	0.1 to 1.2
	6	0.5 to 6
	12	1 to 12
Min. power ON time	0.1 sec min.	2 sec min.

**Note:** If the above minimum power ON time is not secured, the H3CR may not operate. Be sure to secure the above minimum power ON time.

# Specifications

Part number		H3CR-H8L	H3CR-H8RL	H3CR-HRL
Supply voltage (see note)	AC	100 to 120 VAC (50/60 Hz), 200 to 240 VAC (50/60 Hz)		
	AC/DC	24 VAC/VDC (50/60 Hz)		
Operating voltage		85% to 110% of rated supply voltage		
Power consumption	AC	100 to 120 VAC: 0.18 VA (100 VAC applied) 200 to 240 VAC: 0.25 VA (200 VAC applied)		
	AC/DC	24 VAC/DC: 0.24 VA (24 VAC applied)/140 mW (24 VDC applied)		
Start, Reset, Gate inputs		ON-impedance: 1k $\Omega$ max. ON residual voltage: 1 V max. OFF impedance: 500 k $\Omega$ min		
Control outputs	Type	DPDT relay	SPDT relay	DPDT relay
	Max. load	5 A at 250 VAC, p.f. = 1		
	Min. load	10 mA at 5 VDC		
Repeat accuracy		$\pm$ 0.3% full scale max. ( $\pm$ 0.3% full scale max. $\pm$ 10 ms in ranges of 0.6 and 1.2 s)		
Setting error		$\pm$ 5% full scale $\pm$ 0.05 s max.		
Resetting system		Instantaneous operation/ Time-limit reset	Instantaneous operation/Time-limit reset/ Forced reset	
Resetting time		50 ms min.		
Indicators		Output ON indicator (red LED)		
Materials		Plastic case (light gray Munsell 5Y7/1)		
Mounting		Panel, track, or surface depending on socket selected		
Connections		11-pin round socket	8-pin round socket	
Weight		Approx. 120 g (4.23 oz.)		
Approvals		UL/CSA/CE		
Ambient temperature	Operating	-10° to 55°C (14° to 131°F) with no icing		
	Storage	-25° to 65°C (-13° to 149°F) with no icing		
Humidity		35% to 85%		
Vibration	Mechanical durability	10 to 55 Hz with 0.75-mm single amplitude each in three directions		
	Malfunction durability	10 to 55 Hz with 0.5-mm single amplitude each in three directions		
Shock	Mechanical durability	980 m/s <sup>2</sup> (100G) each in three directions		
	Malfunction durability	98 m/s <sup>2</sup> (10G) each in three directions		
Variation due to voltage change		$\pm$ 0.5% full scale max. ( $\pm$ 0.5% full scale max. $\pm$ 10 ms in ranges of 0.6 and 1.2 s)		
Variation due to temperature change		$\pm$ 2% full scale max. ( $\pm$ 2% full scale max. $\pm$ 10 ms in ranges of 0.6 and 1.2 s)		
Service life	Mechanical	10 million operations min. (under no load at 1,200 operations/h)		
	Electrical	100,000 operations min. (5 A at 250 VAC, resistive load at 1,200 operations/h)		
Insulation resistance		100 M $\Omega$ min. (at 500 VDC)		

Note: A power supply with a ripple of 20% max. (single-phase power supply with full-wave rectification) can be used with each DC model.

■ MOUNTING TRACK AND ACCESSORIES

PFP-100N, PFP-50N

PFP-100N2

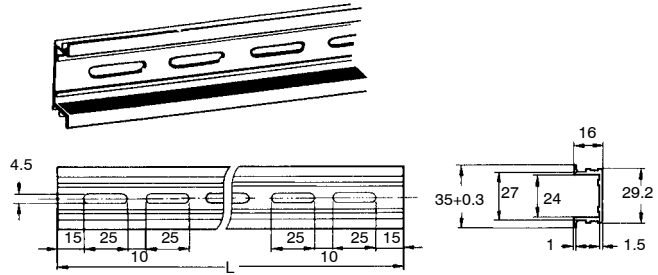
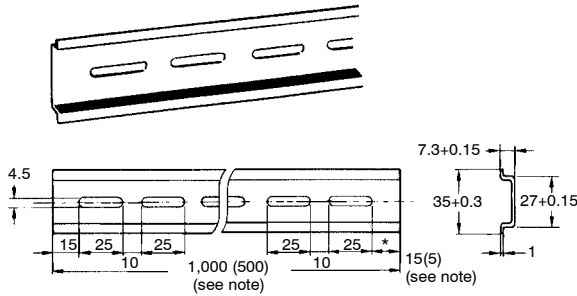

Note: The values shown in parentheses are for the PFP-50N.

PFP-M End Plate

PFP-S Spacer

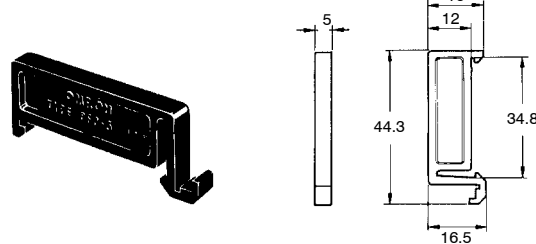
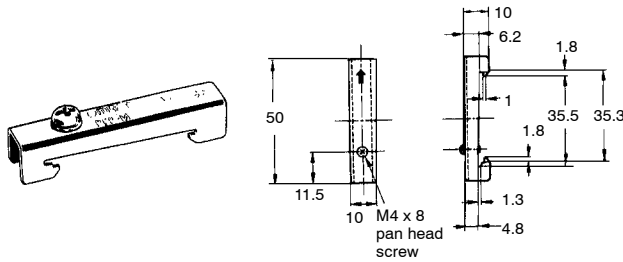

Connections

Part number	Input terminal number		Power supply terminal numbers		Output terminal numbers		
	COM	Reset	AC (common), DC-	AC (hot), DC+	COM	NC	NO
H3CR-H8L	—	—	2	7	1 8	4 5	3 6
H3CR-H8RL	1	4	2	7	8	5	6
H3CR-HRL	5	7	2	10	1 11	4 8	3 9

Installation

■ INPUT CONNECTIONS

The neutral or common of the power supply is connected to terminal 2. Terminal 7 of H3CR-H8L/H8RL and terminal 10 of H3CR-HRL should be connected to the "hot" or positive of the power supply. Terminals 1 and 4 of H3CR-H8RL and terminals 5 and 7 of H3CR-HRL are used for no-voltage forced resetting. Do not connect these terminals to power.

■ OUTPUT CONNECTIONS

Design your control circuit using the relay contacts to switch the load. **Never switch a load with the contact that is being used as an input signal.** The timer's circuitry may be damaged.

■ SELECTING TIME RANGES

A time range (0 to 1.2, 0 to 3, 0 to 12, or 0 to 30) is selected for ON- and OFF-time using the time range selector at the lower left corner of the front panel, and the selected time range appears within the plastic frame of the time setting knob (= scale range display windows).

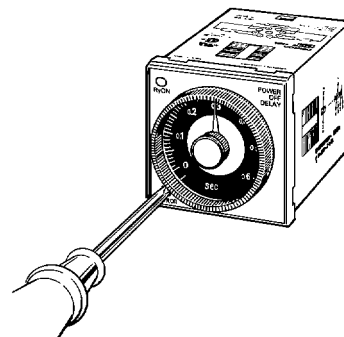

## ■ TRACK MOUNTING

### Using P2CF-Socket

#### Mounting

The P2CF-□□ socket has two hooks that secure the time to the socket. Be sure to allow at least 20 mm (0.79 in) clearance above and below the socket to gain access to release the hooks for servicing and maintenance. Then clip rear of the socket to the track. Push the bottom onto the track until the latch hooks securely.

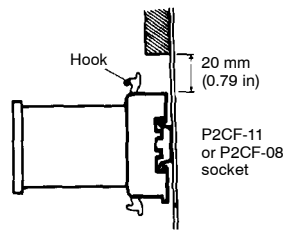

#### Removal

Pull the latch on the socket with a flat-blade screwdriver and remove the timer and socket as one unit.

### Using Y92F-70 and Y92F-71 Adapters

Install the H3CR-H timer, face first, into the back side of the Y92F-70 or Y92F-71 adapter so the bezel fits snugly. Be sure the retaining clips at the back of the adapter fit into the slots on either side of the timer. Compress the top and bottom tabs of the adapter then push the adapter through the front side of the panel cutout. Be sure the tabs extend after the installation for a secure fit.

To remove the timer from the adapter, unclip the two retaining clips at the back of the adapter. To remove the adapter and timer from the panel as a unit, compress the tabs behind the panel and push the unit out the front of the panel.

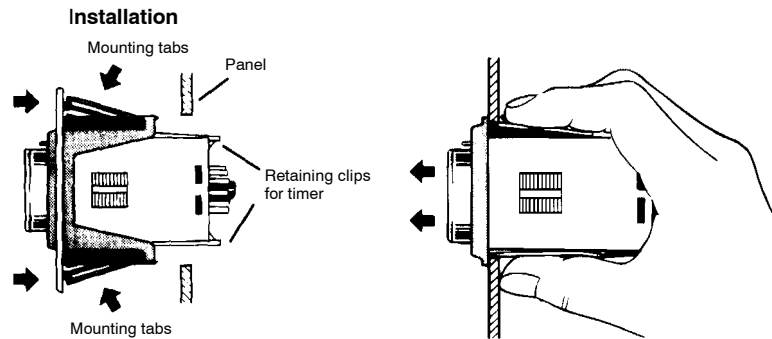

## Precautions

### ■ CAUTIONS

To avoid malfunction or damage, do not change the time unit or time range while the timer is in operation. Be sure to turn off the power supply to the timer before changing any of the selections.

### ■ WIRING PRECAUTIONS

Except for the wiring of the power supply circuit, avoid laying input signal wires in parallel or in the same conduit with high tension or power lines. Use shielded wires or wiring with independent metal conduits for the shortest possible distance.

Never touch the input terminals while power is being applied to the timer to prevent electric shock.

Use an isolation transformer for the power supply of an input device. The transformer's primary and secondary windings should be mutually isolated and the secondary winding not grounded.

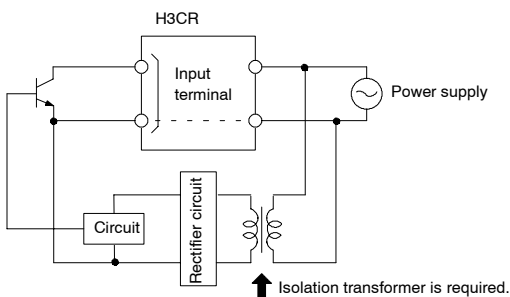

### ■ OPERATING ENVIRONMENT

Do not use the Timer in the following locations.

- Locations with radical temperature changes.
- Locations with high humidity that may result in condensation.
- Locations with excessive vibration or shock.
- Locations with corrosive gas or dust.
- Locations where the Timer is exposed to sprayed water, oil, or chemicals.

Organic solvents (such as paint thinner) as well as strong acid or alkali solutions will damage the outer casing of the Timer.

If the Timer is used in an area with excessive electrical noise, be sure to separate the Timer, wires, and input device as far as possible from the noise sources. The input signal wiring should be shielded to prevent electrical interference.

## ■ PRECAUTIONS FOR EN (VDE) CONFORMANCE

The H3CR-A Series, installed as a built-in timer, conforms to EN61812-1 (VDE0435/P2021) provided that the following conditions are satisfied.

Make sure that no voltage is applied to any terminals before removing the Timer from the Socket.

The output section of the H3CR-A is provided only with basic isolation. Provide supplementary basic isolation on the load side connected to the output so that reinforced isolation required by the EN (VDE) standards will be ensured.

The H3CR-A itself is designed under the following conditions:

- Overvoltage category III
- Pollution degree 2
- Isolation

Operation parts: Reinforced isolation

With clearance of 5.5 mm and creepage distance of 5.5 mm at 230 VAC

Output: Basic isolation (See Note.)

With clearance of 3 mm and creepage distance of 3 mm at 230 VAC

Note: The 11-pin model ensures basic isolation by itself and also ensures basic isolation with the 11-pin model mounted to the OMRON P2CF-11 or P3GA-11 Socket.

Connect the two output contacts different in polarity to the loads so that they will be the same in potential.

## ■ VOLTAGE WITHSTAND TEST

If the Timer is mounted to a control board, remove the Timer from the control board or short-circuit the control board circuitry before carrying out a voltage withstand test between the electric circuitry and non-charged metal part of the Timer. This protects the internal circuitry of the Timer from damage.

**NOTE: DIMENSIONS SHOWN ARE IN MILLIMETERS. To convert millimeters to inches divide by 25.4.**

# OMRON®

**OMRON ELECTRONICS LLC**

One East Commerce Drive  
Schaumburg, IL 60173

**1-800-55-OMRON**

**OMRON ON-LINE**

Global - <http://www.omron.com>  
USA - <http://www.omron.com/oei>  
Canada - <http://www.omron.com/oci>

**OMRON CANADA, INC.**

885 Milner Avenue  
Scarborough, Ontario M1B 5V8

**416-286-6465**