

Solid-state Twin Timers

H3CR-F

CSM_H3CR-F_DS_E_1_2

DIN 48 × 48-mm Twin Timers

- Wide power supply ranges of 100 to 240 VAC and 48 to 125 VDC respectively.
- ON- and OFF-times can be set independently and so combinations of long ON- or OFF-time and short OFF- or ON-time settings are possible.
- Fourteen time ranges from 0.05 s to 30 h or from 1.2 s to 300 h depending on the model to be used.
- Models with a flicker ON start or flicker OFF start are available.
- Easy sequence checks through instantaneous outputs for a zero set value at any time range.
- Length, when panel-mounted with a Socket, of 80 mm or less.
- 11-pin and 8-pin models are available.



Model Number Structure

Model Number Legend

H3CR - F -

1 2 3 4 5

1. Classification

F: Twin timers

2. Configuration

None: 11-pin socket

8: 8-pin socket

3. Twin Timer Mode

None: Flicker OFF start

N: Flicker ON start

4. Time Range

None: 0.05 s to 30 h models

300: 1.2 s to 300 h models

5. Supply Voltage

100-240AC: 100 to 240 VAC

24AC/DC: 24 VAC/VDC

12DC: 12 VDC

48-125DC: 48 to 125 VDC

Ordering Information

List of Models

Operating modes	Supply voltage	0.05 s to 30 h models		1.2 s to 300 h models	
		11-pin models	8-pin models	11-pin models	8-pin models
Flicker OFF start	100 to 240 VAC	H3CR-F 100-240AC	H3CR-F8 100-240AC	H3CR-F-300 100-240AC	H3CR-F8-300 100-240AC
	24 VAC/DC	H3CR-F 24AC/DC	H3CR-F8 24AC/DC	H3CR-F-300 24AC/DC	H3CR-F8-300 24AC/DC
	12 VDC	H3CR-F 12DC	H3CR-F8 12DC	H3CR-F-300 12DC	H3CR-F8-300 12DC
	48 to 125 VDC	H3CR-F 48-125DC	H3CR-F8 48-125DC	H3CR-F-300 48-125DC	H3CR-F8-300 48-125DC
Flicker ON start	100 to 240 VAC	H3CR-FN 100-240AC	H3CR-F8N 100-240AC	H3CR-FN-300 100-240AC	H3CR-F8N-300 100-240AC
	24 VAC/DC	H3CR-FN 24AC/DC	H3CR-F8N 24AC/DC	H3CR-FN-300 24AC/DC	H3CR-F8N-300 24AC/DC
	12 VDC	H3CR-FN 12DC	H3CR-F8N 12DC	H3CR-FN-300 12DC	H3CR-F8N-300 12DC
	48 to 125 VDC	H3CR-FN 48-125DC	H3CR-F8N 48-125DC	H3CR-FN-300 48-125DC	H3CR-F8N-300 48-125DC

Note: Specify both the model number and supply voltage when ordering.

Example: H3CR-F 100-240AC

Supply voltage

■ Accessories (Order Separately)

Name/specifications		Models
Flush Mounting Adapter		Y92F-30
		Y92F-73
		Y92F-74
Mounting Track	50 cm (l) × 7.3 mm (t)	PFP-50N
	1 m (l) × 7.3 mm (t)	PFP-100N
	1 m (l) × 16 mm (t)	PFP-100N2
End Plate		PFP-M
Spacer		PFP-S
Protective Cover		Y92A-48B
Track Mounting/ Front Connecting Socket	8-pin	P2CF-08
	8-pin, finger safe type	P2CF-08-E
	11-pin	P2CF-11
	11-pin, finger safe type	P2CF-11-E
Back Connecting Socket	8-pin	P3G-08
	8-pin, finger safe type	P3G-08 with Y92A-48G (See note 1)
	11-pin	P3GA-11
	11-pin, finger safe type	P3GA-11 with Y92A-48G (See note 1)
Hold-down Clip (See note 2)	For PL08 and PL11 Sockets	Y92H-7
	For PF085A Socket	Y92H-8

Note: 1. Y92A-48G is a finger safe terminal cover which is attached to the P3G-08 or P3GA-11 Socket.

2. Hold-down Clips are sold in sets of two.

Specifications

■ General

Item	H3CR-F	H3CR-F8	H3CR-FN	H3CR-F8N
Operating mode	Flicker OFF start		Flicker ON start	
Pin type	11-pin	8-pin	11-pin	8-pin
Operating/Reset method	Time-limit operation/Time-limit reset or self-reset			
Output type	Relay output (DPDT)			
Mounting method	DIN track mounting, surface mounting, and flush mounting			
Approved standards	UL508, CSA C22.2 No.14, NK, Lloyds Conforms to EN61812-1 and IEC60664-1 (VDE0110) 4kV/2. Output category according to EN60947-5-1.			

■ Time Ranges

0.05 s to 30 h Models

Time unit	s (sec)	×10 s (10 sec)	min (min)	h (hrs)
Setting	1.2	0.05 to 1.2	1.2 to 12	0.12 to 1.2
	3	0.3 to 3	3 to 30	0.3 to 3
	12	1.2 to 12	12 to 120	1.2 to 12
	30	3 to 30	30 to 300	3 to 30

Note: Instantaneous output is available at any time range. To obtain instantaneous output, set to below 0.

1.2 s to 300 h Models

Time unit	×10 s (10 sec)	×10 min (10 min)	h (hrs)	×10 h (10 hrs)
Setting	1.2	1.2 to 12	1.2 to 12	0.12 to 1.2
	3	3 to 30	3 to 30	0.3 to 3
	12	12 to 120	12 to 120	1.2 to 12
	30	30 to 300	30 to 300	3 to 30

Note: Instantaneous output is available at any time range. To obtain instantaneous output, set to below 0.

■ Ratings

Rated supply voltage (See notes 1, 2, and 3.)	100 to 240 VAC (50/60 Hz), 12 VDC, 24 VAC/DC (50/60 Hz), 48 to 125 VDC
Operating voltage range	85% to 110% of rated supply voltage; 90% to 110% with 12-VDC models
Power reset	Minimum power-opening time: 0.1 s
Power consumption	100 to 240 VAC: approx. 10 VA (2.1 W) at 240 VAC 24 VAC/VDC: approx. 2 VA (1.7 W) at 24 VAC approx. 1 W at 24 VDC 48 to 125 VDC: approx. 1.5 W at 125 VDC 12 VDC: approx. 1 W at 12 VDC
Control outputs	Contact output: 5 A at 250 VAC/30 VDC, resistive load ($\cos\phi = 1$)

- Note:**
1. A power supply with a ripple of 20% max. (single-phase power supply with full-wave rectification) can be used with each DC Model.
 2. Do not use an inverter output as the power supply. Refer to *Safety Precautions for All Timers* for details.
 3. Refer to *Safety Precautions for All Timers* when using the Timer together with a 2-wire AC proximity sensor.

■ Characteristics

Accuracy of operating time	±0.2% FS max. (±0.2% FS ±10 ms max. in ranges of 1.2 and 3 s)	
Setting error	±5% FS ±50 ms max.	
Reset time	0.1 s max.	
Reset voltage	10% max. of rated voltage	
Influence of voltage	±0.2% FS max. (±0.2% FS ±10 ms max. in ranges of 1.2 and 3 s)	
Influence of temperature	±1% FS max. (±1% FS ±10 ms max. in ranges of 1.2 and 3s)	
Insulation resistance	100 MΩ min. (at 500 VDC)	
Dielectric strength	2,000 VAC, 50/60 Hz for 1 min (between current-carrying metal parts and exposed non-current-carrying metal parts) 2,000 VAC, 50/60 Hz for 1 min (between control output terminals and operating circuit) 2,000 VAC, 50/60 Hz for 1 min (between contacts of different polarities) 1,000 VAC, 50/60 Hz for 1 min (between contacts not located next to each other)	
Impulse withstand voltage	3 kV (between power terminals) for 100 to 240 VAC, 48 to 125 VDC 1 kV for 12 VDC, 24 VAC/DC 4.5 kV (between current-carrying terminal and exposed non-current-carrying metal parts) for 100 to 240 VAC, 48 to 125 VDC 1.5 kV for 12 VDC, 24 VAC/DC	
Noise immunity	±1.5 kV (between power terminals), square-wave noise by noise simulator (pulse width: 100 ns/1 μs, 1-ns rise) ±400 V for 12 VDC	
Static immunity	Malfunction: 8 kV Destruction: 15 kV	
Vibration resistance	Destruction: 10 to 55 Hz with 0.75-mm single amplitude for 2 hrs each in three directions Malfunction: 10 to 55 Hz with 0.5-mm single amplitude for 10 min each in three directions	
Shock resistance	Destruction: 980 m/s ² three times each in six directions Malfunction: 98 m/s ² three times each in six directions	
Ambient temperature	Operating: -10°C to 55°C (with no icing) Storage: -25°C to 65°C (with no icing)	
Ambient humidity	Operating: 35% to 85%	
Life expectancy	Mechanical: 20 million operations min. (under no load at 1,800 operations/h) Electrical: 100,000 operations min. (5 A at 250 VAC, resistive load at 1,800 operations/h) (See note)	
EMC	(EMI) EN61812-1 Emission Enclosure: EN55011 Group 1 class A Emission AC Mains: EN55011 Group 1 class A (EMS) EN61812-1 Immunity ESD: IEC61000-4-2: 6 kV contact discharge (level 3) 8 kV air discharge (level 3) Immunity RF-interference from AM Radio Waves: IEC61000-4-3: 10 V/m (80 MHz to 1 GHz) (level 3) Immunity RF-interference from Pulse-modulated Radio Waves: IEC61000-4-3: 10 V/m (900±5 MHz) (level 3) Immunity Conducted Disturbance: IEC61000-4-6: 10 V (0.15 to 80 MHz) (level 3) Immunity Burst: IEC61000-4-4: 2 kV power-line (level 3) 2 kV I/O signal-line (level 4) Immunity Surge: IEC61000-4-5: 1 kV line to line (level 3) 2 kV line to ground (level 3)	
Case color	Light Gray (Munsell 5Y7/1)	
Degree of protection	IP40 (panel surface)	
Weight	Approx. 100 g	

Note: Refer to the *Life-test Curve*.

Life-test Curve

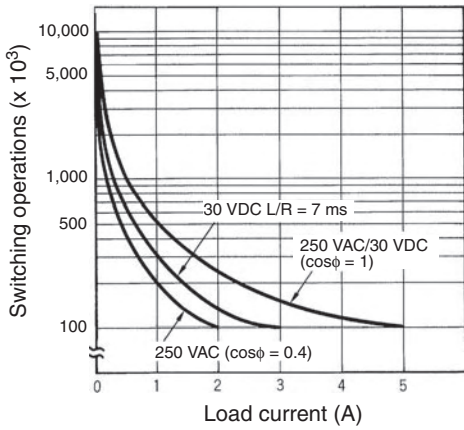

Reference: A maximum current of 0.15 A can be switched at 125 VDC (cosφ = 1) and a maximum current of 0.1 A can be switched if L/R is 7 ms. In both cases, a life of 100,000 operations can be expected. The minimum applicable load is 10 mA at 5 VDC (failure level: P).

Connections

Block Diagrams

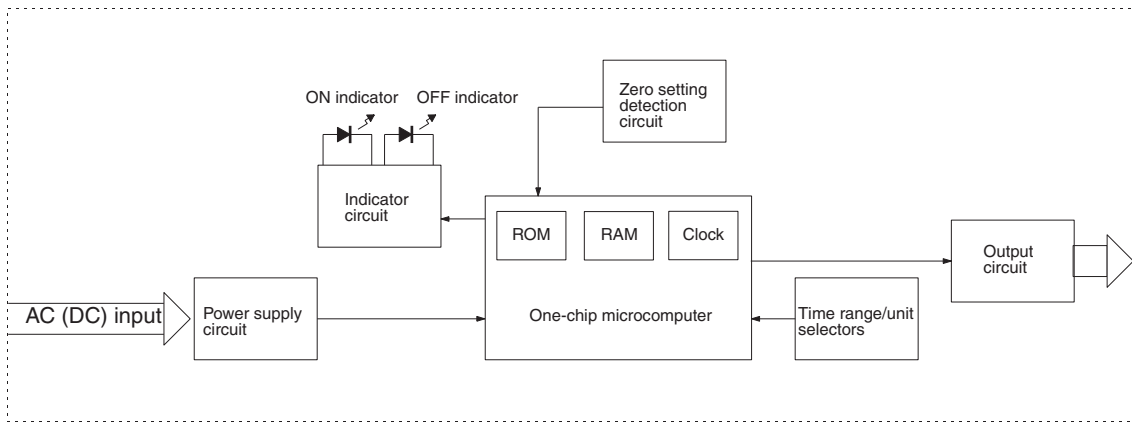

I/O Functions

Inputs	---
Outputs	Control output Outputs are turned ON/OFF according to the time set by the ON- and OFF-time setting knob.

Terminal Arrangement

H3CR-F8
H3CR-F8
NH3CR-F8-300
H3CR-F8N-300

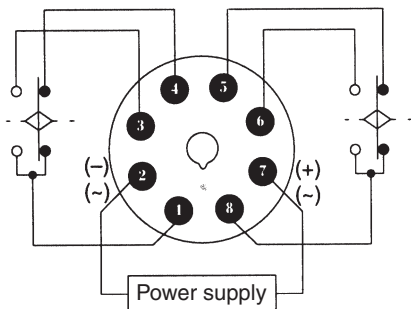

H3CR-F
H3CR-FN
H3CR-F-300
H3CR-FN-300

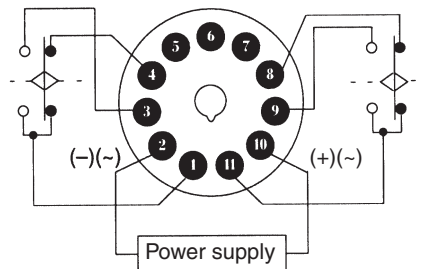

Note: Leave terminals 5, 6, and 7 open. Do not use them as relay terminals.

Operation

■ Timing Chart

t_{ON} : ON set time
 t_{OFF} : OFF set time

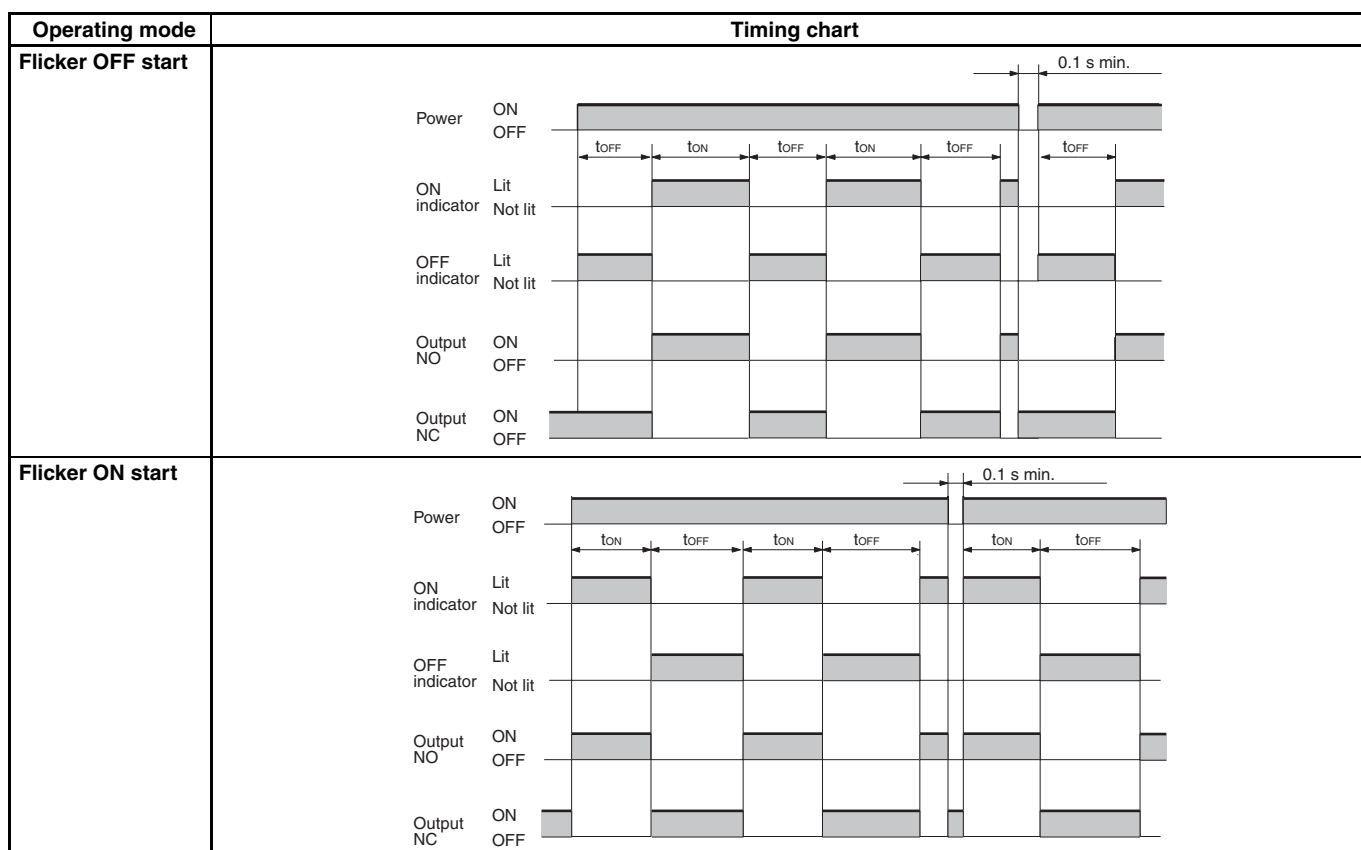

Note: 1. The reset time requires a minimum of 0.1 s.

2. When power is supplied in flicker ON start mode, the OFF indicator lights momentarily. This, however, has no effect on the performance of the Timer.

Connections

	Input terminal number		Power supply terminal numbers		Output terminal numbers		
	COM	Reset	AC (common), DC -	AC (hot), DC+	COM	NC	NO
H3CR-F8 H3CR-F8N H3CR-F8-300 H3CR-F8N-300	—	—	2	7	1 8	4 5	3 6
H3CR-F H3CR-FN H3CR-F-300 H3CR-FN-300	—	—	2	10	1 11	4 8	3 9

Nomenclature

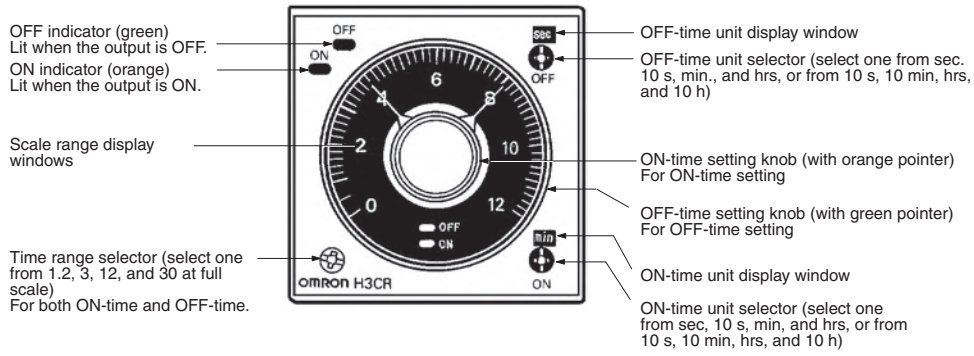

H3CR-F
H3CR-FN
H3CR-F-300
H3CR-FN-300

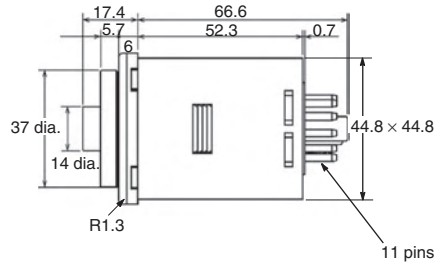
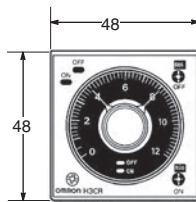
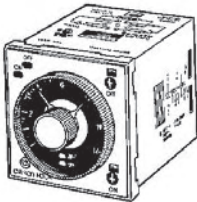

H3CR-F8
H3CR-F8N
H3CR-F8-300
H3CR-F8N-300

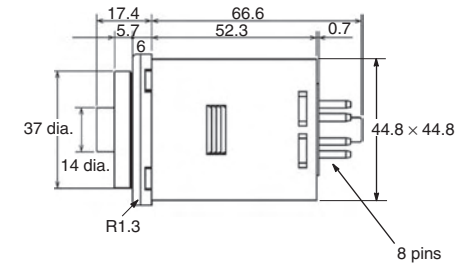
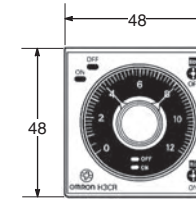
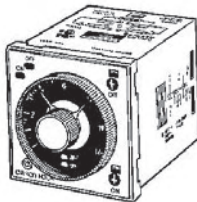

Dimensions with Front Connecting Socket P2CF-08-□/ P2CF-11-□

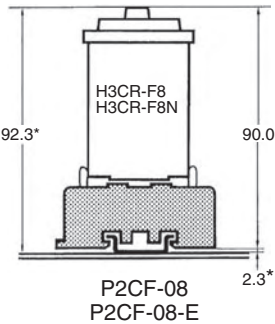
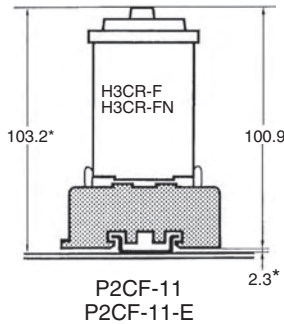

Dimensions with Back Connecting Socket P3G-08/P3GA-11

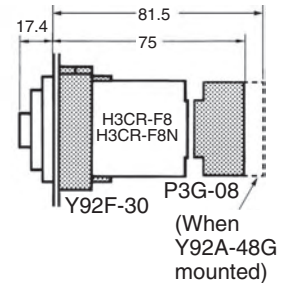
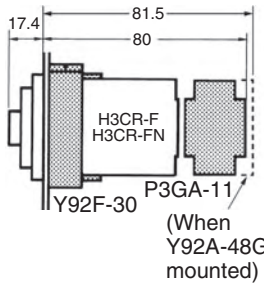

*These dimensions vary with the kind of DIN track (reference value).

ALL DIMENSIONS SHOWN ARE IN MILLIMETERS.
To convert millimeters into inches, multiply by 0.03937. To convert grams into ounces, multiply by 0.03527.

In the interest of product improvement, specifications are subject to change without notice.

Operation

Timing Chart

t_{ON}: ON set time
t_{OFF}: OFF set time

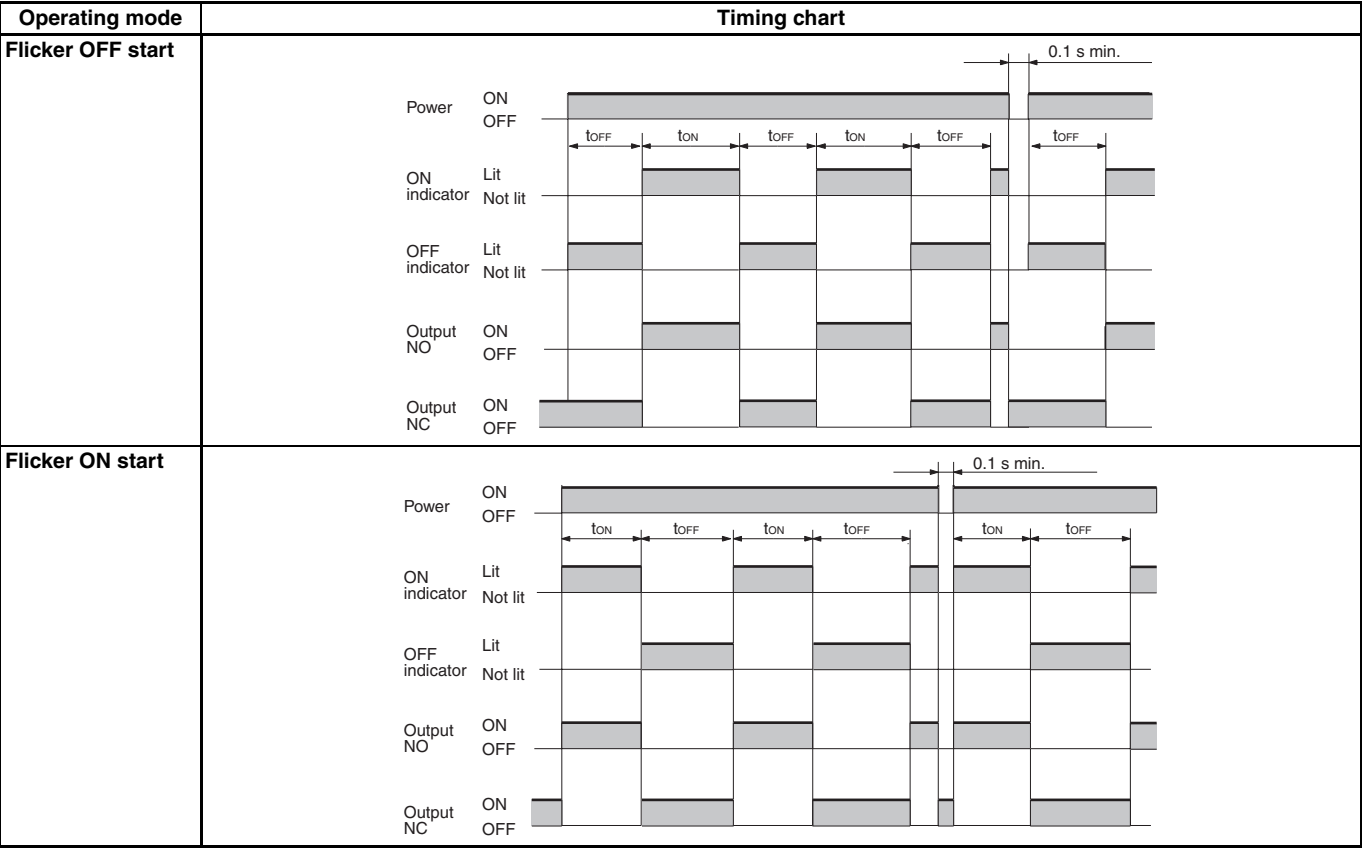

- Note:**
1. The reset time requires a minimum of 0.1 s.
 2. When power is supplied in flicker ON start mode, the OFF indicator lights momentarily. This, however, has no effect on the performance of the Timer.

Nomenclature

