

The position of the override switch H does not affect the operation. With cover plate up, the red neon K is still visible, enabling you to check at a glance whether the light switch is in AUTO (programme mode), in which case the Neon K will come ON if programme is on and OFF if programme is off, or in MANUAL mode when it will flash. To access the controls mode when it will be off. To access the controls again, grip the cover plate with forefinger and thumb either side and ease cover forward.

CHANGING A LIGHT BULB

In the event of a light bulb "blowing" the light switch will fail to operate. Always disconnect power before replacing the bulb by pulling the fuse carrier 'A' until the fuse is fully visible. It may be necessary to replace the fuse if the switch does not operate when the carrier is pushed back into position following bulb replacement. There is a slot in the base of the carrier which allows the old fuse to be pushed upwards and removed.

PROGRAMME PLANNER

In order to ensure that the set programmes do not overlap, it is advisable to plan beforehand, using the table below.

	ON TIME	OFF TIME	MO	TU	WE	TH	FR	SA	SU
e.g. PROG 1	20.10	23.06	X	X	X	X	X	X	X
PROG No 2									
PROG No 3									
PROG No 4									
PROG No 5									
PROG No 6									

e.g. First programme will be set to come on at 8.10pm until 11.06pm everyday.

TROUBLESHOOTING PROBLEMS & SOLUTIONS

1. If the digital display remains blank, press the RESET button. Also, check that the light bulb has not blown.
2. If the light switch will not switch on or off in a one way circuit, check that the screws which fix the security light switch to the wall box have not been over tightened.
3. If the light will not switch on or off from either switch in a two way circuit - (If the above does not solve this problem) the wiring may be incorrect, and requires re-checking. Check that the wire connected to the L2 terminal of the two way switch has been removed and reconnected to the C

- (common) terminal. Incorrect wiring will often result in a blown fuse. Should the switch remain in-operative after correcting the error, replace the fuse with the spare provided.
4. If the light operates correctly from one switch in a two way circuit then the wiring is incorrect. Re-check to find error. Check that the wire connected to the L2 terminal of the two way switch has been removed and reconnected to the C (common) terminal.
 5. If the digital display goes blank when the other switch in a two way circuit is operated, please refer to no. 4 above.

IF A PROBLEM ARISES SOME TIME AFTER INSTALLATION

If loss of time and programmes set occurs after the replacement of either a blown fuse, blown bulb or power failure - Press the RESET button and reset the correct time and day and re-programme the required on and off times.

Every effort has been made to ensure that the guidance information on this sheet will enable the installation of the security light switch to be carried out safely and correctly.

TECHNICAL DATA

Rated Voltage: 230V, AC ~ 50Hz
 Load: Max 400W - Min 40W + most Low Energy (CFL) 11W & above

Integral 2 amp fuse

ALWAYS REPLACE WITH A SPECIAL 2AMP BS646 FUSE. (THIS IS NOT AN ORDINARY 2AMP FUSE)

PLEASE KEEP THESE INSTRUCTIONS SAFE FOR FUTURE REFERENCE



GREENBROOK
 ELECTRICAL PLC
 WEST ROAD . HARLOW
 ESSEX . CM20 2BG . UK
 sales@greenbrook.co.uk
 WWW.GREENBROOK.CO.UK

Issue no: 701559

GREENBROOK
 ELECTRICAL PLC

ELECTRONIC WALL SWITCH TIMER INSTALLATION/OPERATING INSTRUCTIONS

MODEL NUMBER: T40S-C

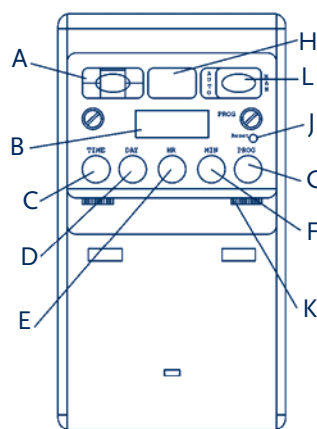

- A. FUSE CARRIER Pull out to replace fuse (a special 2A BS646 20mm x 5mm, this is not an ordinary fuse)
- B. LCD DISPLAY
- C. to G. BUTTONS TO SET DAY, TIME AND PROGRAMME AND RANDOM
- H. PUSH ON/OFF SWITCH ALLOWS UNIT TO OPERATE AS ORDINARY LIGHT SWITCH ACTIVATES EVEN WHEN LID IS SHUT.
- L. OVERRIDE SWITCH
 MAN = MANUAL MODE
 AUTO = AUTOMATIC PROGRAMME MODE
- J. RESET BUTTON
- K. RED NEON FUNCTION

IF IN DOUBT, INSTALLATION SHOULD BE MADE BY A QUALIFIED ELECTRICIAN IN ACCORDANCE WITH CURRENT WIRING REGULATIONS

WIRING INSTRUCTIONS

Before attempting any installation work turn off the electrical supply at the mains switch, fuse box or consumer unit and for additional safety remove the fuse. GreenBrook security wall light switches cannot be used with other electronic products.

1. After installation, the internal back up battery will need to be fully charged to enable correct operation.
2. After the main supply is switched back on, wait 5 minutes and operate the reset button and allow the internal battery to charge for 45-60 minutes. After this period follow the operating instructions as normal.
3. DO NOT use in two-way systems with dimmers or any other switch containing electronic circuitry.

4. Suitable for tungsten filament bulbs 40W to 400W maximum and most low energy (CFL) 11W and above. Not suitable for low voltage lighting.
5. Not suitable in 3-way circuits.

NOTE

If using a metal backbox this should be earthed.

WIRING INSTALLATION IN ONE WAY SWITCHED CIRCUIT

Diagram 1- Before

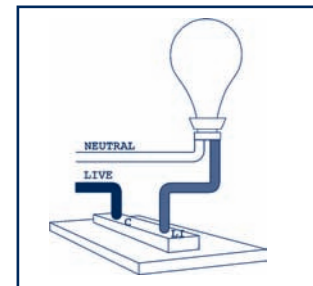
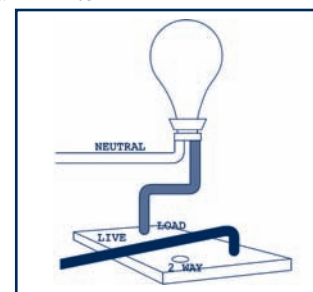

Diagram 2 - After



YELLOW & GREEN EARTHS MUST REMAIN CONNECTED TO METAL BACK BOX

WIRING INSTALLATION IN TWO WAY SWITCHED CIRCUIT

Before installing your Security Wall Light Switch in a two way circuit, it is first necessary to determine which method of wiring has been used in your home. The primary reason for doing this is to make sure that the switch is wired in such a way that has a permanent live feed at all times in order to power the electronic timer.

1. TURN OFF THE MAIN SUPPLY
2. Loosen the two switch plates from the wall.
3. Do NOT disconnect any wires at this stage.
4. Study the existing wiring arrangement; compare to the 'before' illustrations. -If you find 3 wires at each switch (excluding the earth wire) see Diagram 3. -If you find 5 wires at one switch and 5 wires at the other (excluding the earth wire) see Diagram 5. After establishing the appropriate wiring method, install the security light switch as per the corresponding 'after' illustration.

Diagram 3 - Before

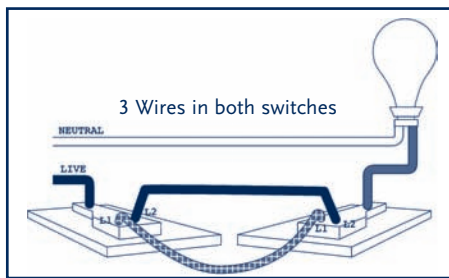
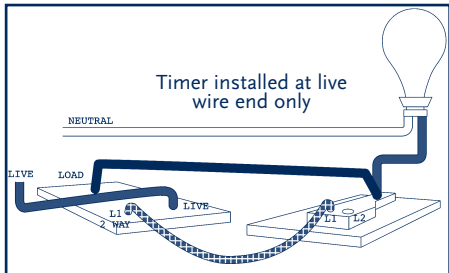

Diagram 4 - After



YELLOW & GREEN EARTHS MUST REMAIN CONNECTED TO METAL BOX

WIRING INSTALLATION FOR 5 & 3 WIRE ARRANGEMENT

Diagram 5 - Before

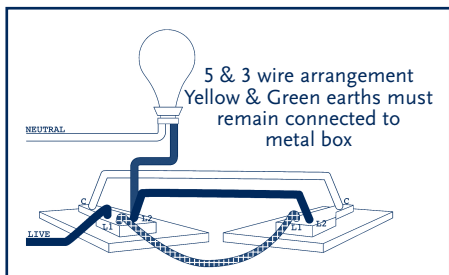

Diagram 6 - After

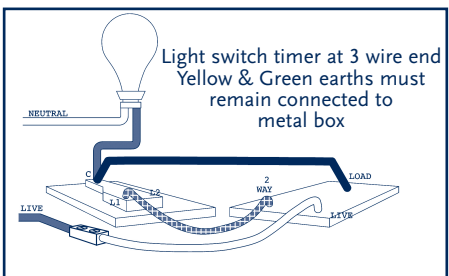
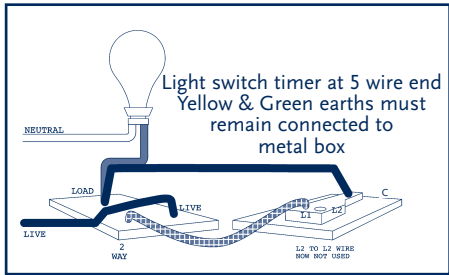

Diagram 7 - After



PROGRAMMING LIGHT SWITCH

1. Ensure light fitting(s) being controlled have bulb(s) fitted, otherwise light switch will not function.
2. After installation is complete, reconnect power at the mains (remembering to replace fuse if removed for safety reasons). The red neon K and the L.C.D. display B will now be flashing. (Allow internal battery to charge for 45 minutes).

SETTING PRESENT DAY & TIME

To access controls, with thumb and forefinger on either side, ease cover forward. With tip of ballpoint pen, press reset button J to clear memory. Press and hold down TIME button C continuously. Press DAY button D until present-day is displayed. Press HR and MIN buttons E and F until correct time is set using a 24-hour clock. Release TIME button C. e.g. L.C.D. display B showing current time is 3.15pm on Wednesday.

WE
15.15

NOTE
Continued pressure on any of the DAY, HR, MIN buttons whilst TIME button is depressed will advance the display rapidly.

SETTING A PROGRAMME

There are a maximum of 6 ON and 6 OFF times available. Each ON/OFF time can be used individually on any day(s) throughout the week, OR can be set to repeat on one of the following combination of days: to run a programme, override switch L must be in the auto position.
MO TU WE TH FR SA SU (days of the week);
MO TU WE TH FR (weekdays);
SA SU (weekends)
MO TU WE TH FR SA (workdays only);

EXAMPLE 1

If you wish to switch light automatically every day of the week at 20:10 (8:10pm) and OFF at 23:06 (11:06pm).

STEP 1
Press the PROG button G and release.

MO TU WE TH FR SA SU
TIMER ---:--
ON

The colon in the centre will flash

The first time can be entered:

STEP 2
Press DAY button D until required day or combination of days is displayed. In the above case, press until ALL THE DAYS appear on the top.

STEP 3
Press HR button E until 20 shows:

MO TU WE TH FR SA SU
TIMER 20:--
ON

STEP 4
Press MIN button F until 10 minutes are set:

MO TU WE TH FR SA SU
TIMER 20:10
ON

STEP 5
Press PROG button G so that the first OFF time can be entered:

MO TU WE TH FR SA SU
TIMER ---:--
OFF

STEP 6
Press HR button E until 23 shows:

MO TU WE TH FR SA SU
TIMER 23:--
OFF

STEP 7
Press MIN button F until 06 minutes are set:

MO TU WE TH FR SA SU
TIMER 23:06
OFF

STEP 8
Up to 6 ON and 6 OFF programmes are available and it is not necessary to use them all. Press TIME button C to revert back to clock.

EXAMPLE 2

If you wish to have a second programme which switches your light on at 18:00 hours (6.00pm) and off at 22.30 hours (10.30pm) every saturday and sunday only.

STEP 1
Press PROG button G and previous ON setting will appear. Keep pressing PROG G until you have stepped through all the previous ON/OFF settings and until you come to the first display, which has 4 dashes:

TIMER ---:--
ON

STEP 2
Press DAY button D until only SA and SU appear:

MO TU WE TH FR SA SU
TIMER ---:--
ON

STEP 3 & 4
Press HR and MIN buttons E and F to set required ON time (zeros must be entered):

MO TU WE TH FR SA SU
TIMER 18:00
ON

STEP 5
Press PROG button G to set OFF time:

STEP 6
Press DAY button D until both SA and SU appear as above:

STEP 7
Press HR and MIN buttons E and F to set required off time:

MO TU WE TH FR SA SU
TIMER 22:30
OFF

STEP 8
Press TIME C to revert back to CLOCK.

IMPORTANT NOTE:
Ensure the day(s) selected in the programme ON mode matches day(s) selected into the programme OFF mode.

RANDOM FUNCTION

Once programming is completed, the lamp can be switched on and off at varying times on a daily basis if RANDOM FUNCTION is selected. Simply press DAY D and HR E buttons simultaneously. The word TIMER will flash to show RANDOM mode is activated. To cancel RANDOM, press DAY D and HR E simultaneously again and the word TIMER will disappear.

NOTE: The random feature works by randomly shifting the ON/OFF times of your set programmes between 2 and 30 minutes at each operation.

REVIEWING SET PROGRAMMES

Press PROG G and on each occasion all previously set ON and OFF times will be displayed. Any alterations can be made by pressing button D, E and F as appropriate. Blank ON/OFF times will have 4 dashes instead of numbers. New programmes can be entered by following steps 1 to 8 in example 1.

AUTOMATIC OR MANUAL CONTROL - OVERRIDE SWITCH

During those occasions when you are at home early and you do not want your security light switch to operate as programmed, slide switch L so that MAN shows for manual only operation. The pre-set programmes are still stored. The switch can operate only via push switch H. The red neon K will flash. To recall AUTOMATIC programme (i.e. to activate switch to pre-set programmes) slide OVERRIDE switch L so that AUTO shows. Neon light K will come ON if programme is on and OFF if programme is off.

MANUAL ON/OFF OPERATION

When all settings have been completed, close the front cover plate until it clicks into position, concealing the operating controls. The room light(s) can be turned ON and OFF by simply pressing the top front cover once, or by operating the switch at the other end of a 2-way circuit.