

## H3D-M MULTI-FUNCTION ANALOGUE TIMER

Stocked and distributed by Ingram Products Inc, Jacksonville, FL  
[www.ingramproducts.com](http://www.ingramproducts.com)



### CHARACTERISTICS :

- Wide operating voltage range, AC/DC 12V~240V
- 7 output modes :  
 On-delay  
 Control contact OFF-delay  
 Interval  
 Trailing edge interval  
 Flasher starting with ON  
 Flasher starting with OFF  
 Single shot
- 7 time range, from 1 second to 100 hour
- 17.5 mm thin body design
- UL, C-UL recognized and CE certified

### SPECIFICATION :

|                                   |  |
|-----------------------------------|--|
| Operating voltage                 | AC/DC(V): 12~240   |
| Allowable operating voltage range | 90~110% of rated operating voltage                       |
| Rated frequency                   | 50 / 60 Hz   |
| Contact rating                    | 250VAC 8A (resistive load)                               |
| Reset time                        | MAX 0.1s   |
| Power consumption                 | Approx. 1.9VA  |
| Life                              | Mechanical: 5,000,000 times<br>Electrical: 100,000 times |
| Ambient temperature               | -10 ~ +50°C  |
| Ambient humidity                  | MAX 85%RH  |
| Weight                            | Approximatly 62g   |

### TYPE SELECTION :

|                |   |
|----------------|---|
| Type           | H3D-M                                     |
| Time range     | 1s / 10s / 100s / 10m / 100m / 10h / 100h |
| Output contact | 1C  |
| Output mode    | 7 Mode                                    |

## CONNECTION :

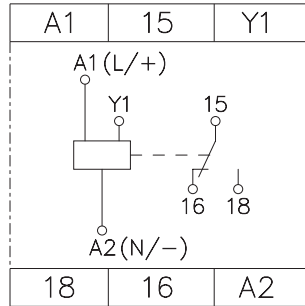

## TIMING CHART :

Mode A: On-delay,

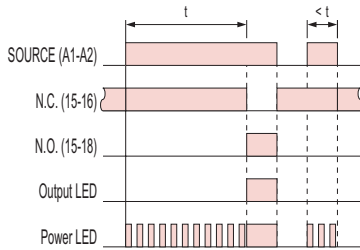

Mode B: Flasher starting with OFF,

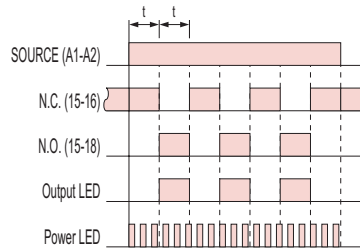

Mode B2: Flasher starting with ON,

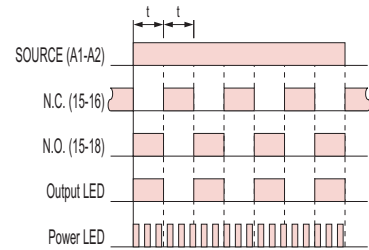

Mode D: Control contact OFF-delay,

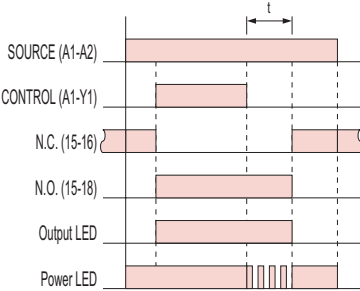

Mode D1: Trailing edge interval,

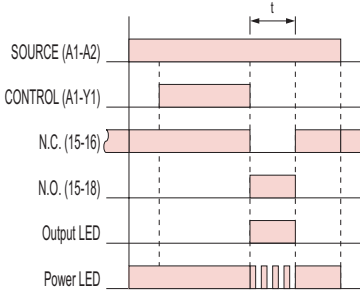

Mode E: Interval,

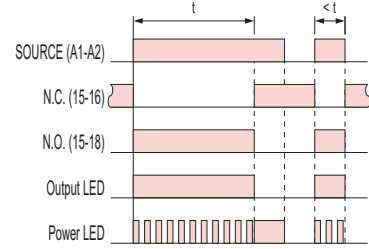

## DIMENSIONS : (mm)

Mode J1: Single shot,

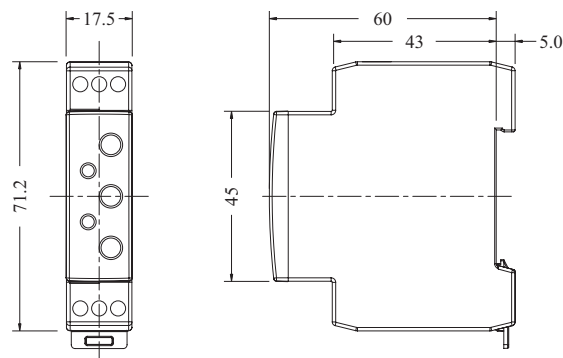
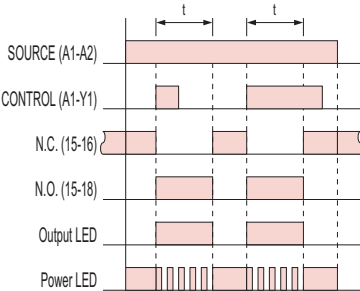

**ANLY ELECTRONICS CO., LTD.**

<http://www.anly.com.tw>

**TAIWAN MAIN OFFICE : ANLY ELECTRONICS CO., LTD.**

No. 19, Lane 202, Fushou St., Shinjuang City, Taipei, Taiwan 242  
TEL: +886-2-2996-3202 FAX: +886-2-2996-2017

**MALAYSIA BRANCH : JUSTY ELECTRONICS (M) SDN, BHD.**

No. 1, Jalan 6/89B, Kawasan Perindustrian Trisegi, Batu 3 1/2 Off Jalan Sungei Besi, 57100 Kuala Lumpur, Malaysia  
TEL: +60-3-7983-5758 FAX: +60-3-7981-5052

**HONG KONG BRANCH : ANLY ELECTRONICS (HK) LTD.**

Flat K, 13/F, Edward Mansion, 141 Prince Edward Road W., Kowloon, Hong Kong  
TEL: +852-2397-2505 FAX: +852-2397-6080

**SHANGHAI BRANCH : ANLY TECHNOLOGY (WUXI) CO., LTD.**

Room 13G, No.831, Xinzha Rd., Jingan District, Shanghai, China 200041  
TEL: +86-21-6218-3300 FAX: +86-21-6217-5911

NO. H3DM-H-A



# H3D-M

MULTI-FUNCTION ANALOGUE TIMER

## User's Manual

### RESTRICTIONS ON USE

When using this product in applications that require particular safety or when using this product in important facilities, please pay attention to the safety of the overall system and equipment. Install fail-safe mechanisms, perform redundancy checks and periodic inspections and adopt other appropriate safety measures when it is necessary. This product is rated at Class II □.

### SAFETY PRECAUTION

This manual uses the following symbols to ensure safe operation of this timer.

- WARNING** Warnings are indicated when mishandling this product might result in death or serious injury to user.
- CAUTION** Cautions are indicated when mishandling this product might result in minor injury to the user, or only physical damage to the timer.

### WARNING

- Note this incorrect wiring of this product can damage it and lead to other hazards. Make sure the product has been correctly wired before turning the power ON.
- Before wiring, or removing / mounting the product, be sure to turn the power OFF. Failure to do so might cause electric shock.
- Do not touch electrically charged parts such as the power terminals. Doing so might cause electric shock.
- Do not disassemble the product. Doing so might cause electric shock or faulty operation.

### CAUTION

- Use the product within the operating ranges recommended in the specification (temperature, humidity, voltage, shock, mounting direction, atmosphere and etc.). Failure to do so might cause fire or faulty operation.
- Firmly tighten the wires to the terminal. Insufficient tightening of the wires to the socket might cause fire.

| SPECIFICATIONS                    |   | FACEPLATE |  |
|-----------------------------------|---|-----------|--|
| Operating voltage                 | AC/DC : 12~240V   |           | <p><b>Power LED:</b><br/>ON : Supply voltage applied<br/>OFF : No supply voltage<br/>Flashing : During timing</p> <p><b>Output LED:</b><br/>ON : Output relay energized<br/>OFF : Output relay de-energized</p> <p><b>Range:</b><br/>1s, 10s, 100s, 10m, 100m, 10h, 100h at Full Scale</p> <p><b>Time:</b><br/>0 ~ Full Scale adjustment</p> <p><b>Mode:</b><br/>Timing mode selection</p> |
| Allowable operating voltage range | 90 ~ 110% of rated operating voltage                      |           |  |
| Rated frequency                   | 50 / 60Hz   |           |  |
| Contact rating                    | 250VAC 8A (Resistive load)                                |           |  |
| Reset time                        | MAX 0.1s  |           |  |
| Power consumption                 | Approx. 1.9VA   |           |  |
| Life                              | Mechanical : 5,000,000 times / Electrical : 100,000 times |           |  |
| Ambient temperature               | -10 ~ +50°C   |           |  |
| Ambient humidity                  | MAX 85% RH  |           |  |
| Weight                            | Approximately 62g   |           |  |

### TIMING CHART

#### Mode A: On-delay, □

Timing starts when supply voltage is applied to A1-A2. When the timing completes, the output relay energizes. Interrupting supply voltage resets the timing.

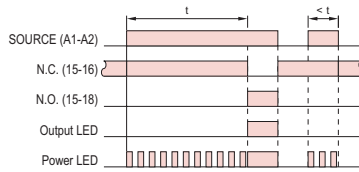

\*The control contact A1-Y1 is without function in this mode.

#### Mode B: Flasher starting with OFF, □

Timing starts when supply voltage is applied to A1-A2. The timing cycle starts with an OFF time, then changes to ON time of equal length and continues the OFF-ON cycle until the supply voltage is interrupted.

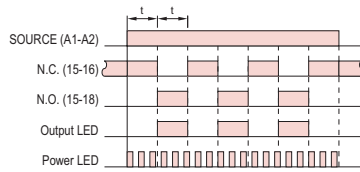

\*The control contact A1-Y1 is without function in this mode.

#### Mode B2: Flasher starting with ON, □

Timing starts when supply voltage is applied to A1-A2. The timing cycle starts with an ON time, then changes to OFF time of equal length and continues the ON-OFF cycle until the supply voltage is interrupted.

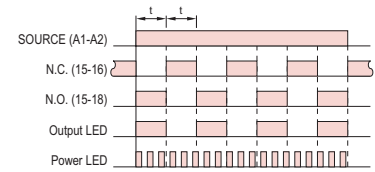

\*The control contact A1-Y1 is without function in this mode.

#### Mode D: Control contact OFF-delay, □

With supply voltage applied at A1-A2, when the control contact A1-Y1 is held closed, the output relay energizes. When the timing completes, the output relay de-energizes. Closing A1-Y1 during timing resets the timing.

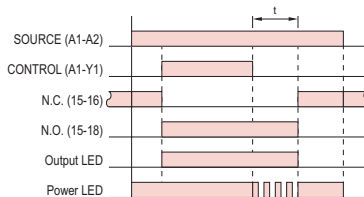

#### Mode D1: Trailing edge interval, □

With supply voltage applied at A1-A2, when the control contact A1-Y1 is opened, the timing starts and the output relay energizes. When the timing completes, the output relay de-energizes. Closing A1-Y1 during timing de-energizes the output relay and resets the timing.

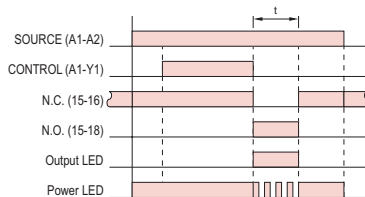

#### Mode E: Interval, □

Timing starts and the output relay energizes when supply voltage is applied to A1-A2. When the timing completes, the output relay de-energizes. Interrupting supply voltage resets the timing.

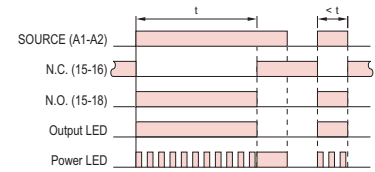

\*The control contact A1-Y1 is without function in this mode.

#### Mode J1: Single shot, □

With supply voltage applied at A1-A2, timing starts by closing control contact A1-Y1 and output relay energizes during the timing. When the timing completes, the output relay de-energizes. After completion, closing A1-Y1 restarts timing. Operating A1-Y1 during timing or holding it closed has no effect.

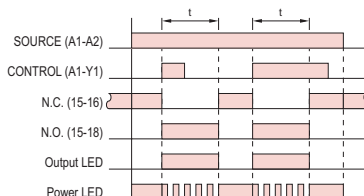

### CONNECTION

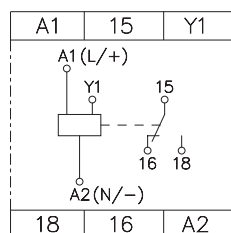

### DIMENSION(mm)

