

Turnus 771 and 772

GRÄSSLIN
YOUR SENSES. OUR SOLUTIONS.

turnus 771 plus
turnus 772 plus

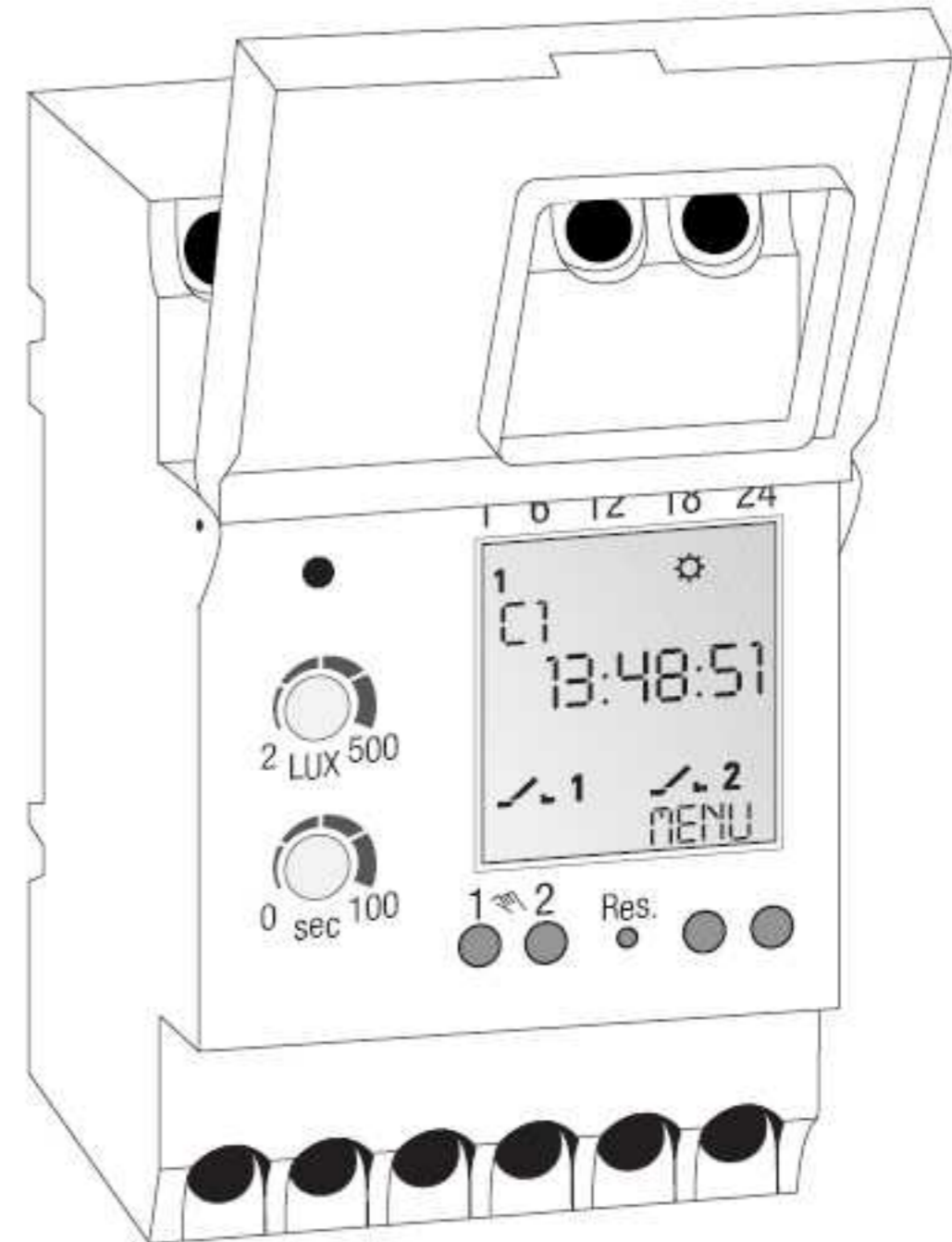



Table of contents



Safety instructions..... 24



Product details..... 25

- Product description..... 25
- Intended use..... 25
- Technical data 26



Installation and assembly 27

- Assembly on DIN-rail 27
- Connecting and mounting the brightness sensor 27
- Wiring diagram 28
- Set-up 29



Operation and adjustment 30

- Display and function keys 30



- Menu structure 33
- Initial start-up – Language menu 34
- Date and time setting 34
- Daylight Saving Time 35
- New program..... 36
- View and edit programs 38
- Delete program..... 39
- Switching mode..... 40



Disposal / Recycling 41



Safety instructions



DANGER

Danger! Risk of electric shock!

- ▷ Connection and mounting must be realized by a professional electrician!

- Please observe the national regulations and safety instructions.
- Interferences and changes to the device will invalidate the warranty and guaranty rights.
- Minimum diameter of the flexible lines for the terminals: 1 mm².
Maximum diameter: 4 mm²

Read and observe these instructions to guarantee a perfect function of the device and a safe operation.



Product details

Product description

Photoelectric switch

- 1 channel or 2 channel
- Adjustable ON/OFF switching delay: 0-100 sec.
- Up to 10 devices (20 channels) can be combined to build a light control system with just one brightness sensor.
- With weekly timer

Intended use

- The photoelectric switch is used for
 - lighting in private homes and commerce
 - advertising
 - street lighting
 - shop window lighting
 - car park lighting
 - controlling shutters and blinds
- Mounting only on DIN rails.
- Intended only for use in dry areas!



Technical data

AC switching capacity:

– Ohmic load (VDE, IEC)	16 A / 250 V AC
– Inductive load cos. φ 0,6	10 A / 250 V AC
– Incandescent/halogen lamp load	2600W
– Fluorescent lamp	1000W
– Rated load AC1 / AC15	3700W / 750W

Ambient temperature:

– Control unit / Brightness sensor	-10°C ... + 55°C / -30°C ... + 70°C
------------------------------------	-------------------------------------

Protection type:

– Control unit / Brightness sensor	IP 20 / IP 65
------------------------------------	---------------

Photoelectric switches:

– Adjustment range	2 lx – 500 lx
– Switching delay	adjustable: appr. 0-100s ON/0-100s OFF

Time switch:

– Memory spaces	50
– Accuracy	typ \pm 1 s/day at +20°C
– Running reserve	3 years from factory



Installation and assembly



Danger! Risk of electric shock!

▷ Connection and mounting must be realized by a professional electrician!

Assembly on DIN-rail

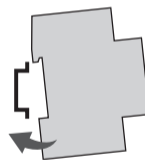

Put the device slightly inclined on top of the rail. Then push it backwards until it engages.

Connecting and mounting the brightness sensor

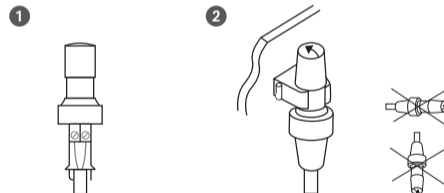

- Length of the connecting cable: max. 100 m
- Line cross-section: min. 2 x 0.75 mm²



Wiring diagram



If you connect the sensor to the + and - terminals, you must connect a jumper between terminals B1 and B2.

If you operate several devices on one sensor, this jumper may only be used for one device.

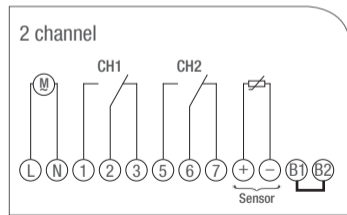
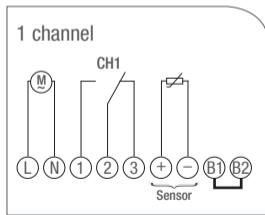

Set-up



If you connect the sensor to the + and - terminals, you must connect a jumper between terminals B1 and B2.

If you operate several devices on one sensor, this jumper may only be used for one device.

The device - twilight switch and timer - only activates the output (terminals 1 and 5) when all three conditions are fulfilled:

- brightness is lower than the adjusted value
- the adjusted delay time has passed
- the timer is set to = ON

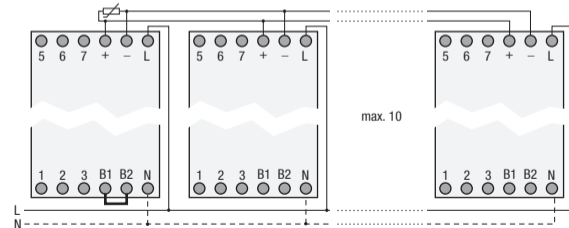
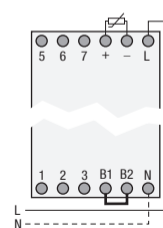



Operation and adjustment

Display and function keys

- The central line of the display, in which the adjusted values and selected menu items are displayed, is displayed larger.
- Flashing means that an entry is required. If you do not enter anything within two minutes, the timer switches back to automatic operation.
- The programs are maintained when resetting. You need to readjust date and time. Press the reset button using a blunt object (ball-point pen).

Adjusting the lux value

Turn the rotary switch to adjust the desired lux value (2-500 lx).

- ▷ The LED is lighted as soon as the surrounding brightness is lower than the adjusted lux value.

Adjusting the delay time

Turn the rotary switch to adjust the desired delay time (0-100 sec).

- ▷ This reduces incorrect switching due to short-term external light effects, such as lightning, etc.

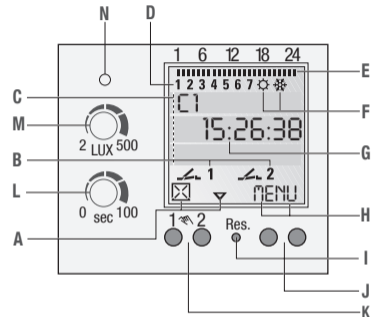

Display

- A Function displays of the two left-hand buttons
- B Channel status displays
- C 3-line LCD display
- D Day-of-week display
- E Overview of daily switching program
- F Indicates Daylight Saving Time
- G Operating voltage (permanently lit dots)
- H Reserve power operation (dots flash)
- H Function displays of the two right-hand buttons

Buttons/Switches

- I Reset
- J Right-hand buttons
- K Left-hand buttons with manual switch function in Automatic mode
- L Button for ON/OFF switching delay
- M Button for adjusting the Lux value
- N Switching state display without delay



Functions of the left-hand buttons:

- △ scroll up in menu
- ▽ scroll down in menu
- ☒ Select/reject suggestion
- ✓ Select/accept suggestion
- + Press briefly = +1 / Press and hold (approx. 2 sec) = +5
- Press briefly = -1 / Press and hold (approx. 2 sec) = -5

Functions of the right-hand buttons:

- MENU** Exits the Automatic mode and enters the Programming mode
- ESC** Press briefly = one step back
Press and hold (approx. 2 sec) = return to Automatic mode
- OK** Make selection and apply
- EDT** Change request in "Review mode"
- NO** Do not execute command
- YES** Execute command
- DEL** Delete



Menu structure

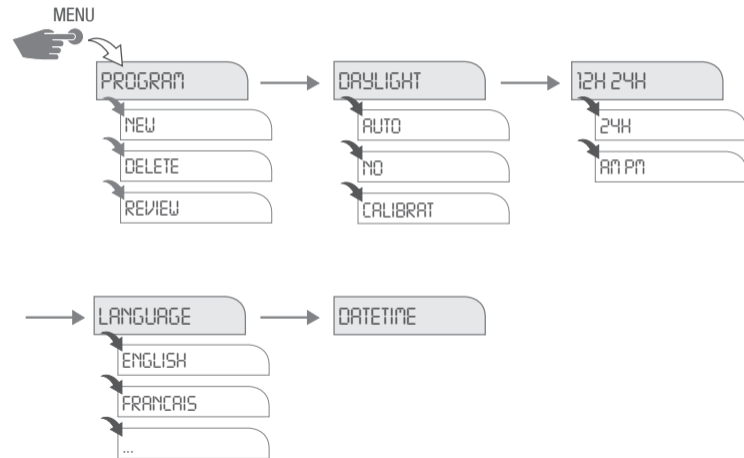



Initial start-up – Language menu

- i** When delivered, the timer is in automatic mode with preset time, date (CET) and menu in English. Press the Menu button to make settings. Then select the desired setting.

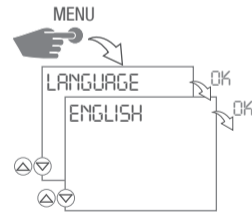

Date and time setting

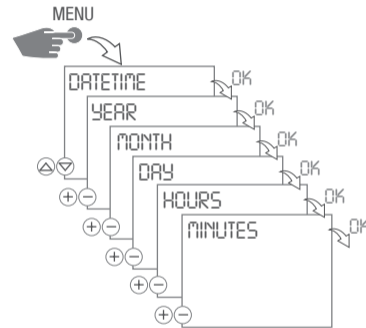

- i** In the menu **12H 24H** you can choose between AM/PM and 12/24-hour announcement.



Daylight Saving Time

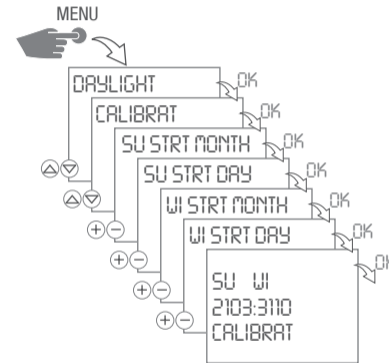

The following settings are possible:

AUTO

Factory presetting of the published calendar dates (CET). This is automatically recalculated for each year.

NO

No switchover.

CALIBRAT

Programming. The start date of the summer time and winter time must be entered for this purpose. The factory presetting is overwritten.

The programmed summer/ winter time is automatically recalculated for each year. The changeover takes place on the same specified day of the week in the same week of each month.



New program

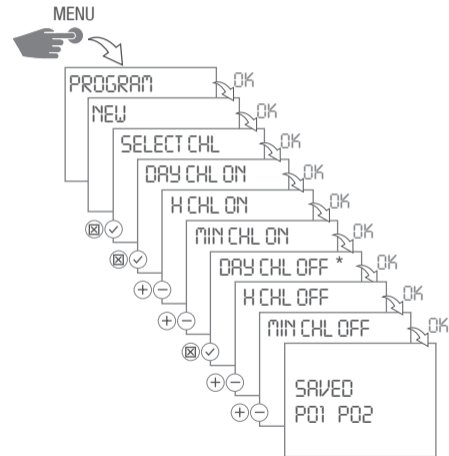

*) Available only if individual days have been selected for the ON command.



1. Press the Menu button.
2. Confirm **PROGRAM** by pressing **OK**.
3. Confirm **NEW** by pressing **OK**.
▷ Free memory space is briefly displayed.
4. For 2-channel version only:
Select a channel and confirm by pressing **✓**. → **OK**
▷ The weekday display is flashing.

ON command:

5. Select the desired days and confirm by pressing **✓**. → **OK**
6. Enter the hours (+/-) → **OK**
7. Enter the minutes (+/-) → **OK**

OFF command:

8. If requested, select the desired days and confirm by pressing **✓**. → **OK**
9. Enter the hours (+/-) → **OK**
10. Enter the minutes (+/-) → **OK**
▷ The program is saved.



View and edit programs

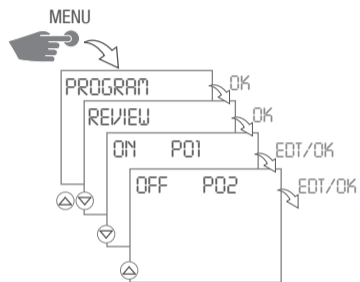

- Press Δ ∇ to scroll through the different program steps.
- Press **OK** to get to the next program.
- Press **EDT** to edit a program.
This procedure is similar to creating a new program.



Delete program

Delete all programs

- Press **YES** to delete all programs.
- Press **NO** to delete individual programs.

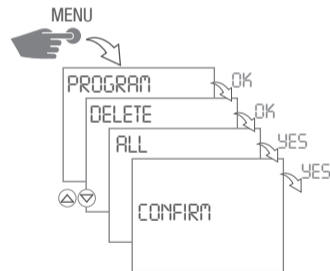

Delete individual programs

- For deleting individual programs, all belonging program steps are deleted (e.g. P01 ON and P02 OFF).
- Press **OK** to get to the next program.

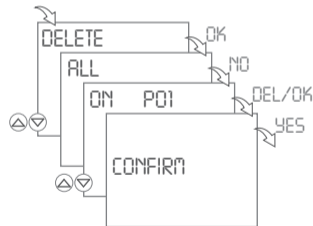

80.10.1237.7/09/09/01

Grässlin GmbH

Bundesstraße 36
D-78112 St. Georgen
Germany

Phone: +49 (0) 7724 / 933-0

Fax: +49 (0) 7724 / 933-240

www.graesslin.de

info@graesslin.de