











# Instruction Manual



20 memories time switches



	Safety precautions .....	19
	Assembly.....	20
	Symbols, keys .....	21
	Setting the timer .....	22
	Setting 24h or am/pm clock, time and weekday .....	22
	Pre-set programs.....	24
	Selecting pre-set programs P01 to P03.....	25
	User defined programs.....	27
	Deleting programs .....	30
	Summer/winter time.....	31
	Automatic operation / fixed ON / fixed OFF .....	31



## Safety precautions

- The connection and installation of electrical devices may only be carried out by a qualified electrician.
- Interventions in and changes to the device result in the voiding of the warranty claim.
- Observe your national regulations and the respective safety provisions.
- Switch-off commands have priority over switch-on commands.



## Assembly

### MIL 72 D120

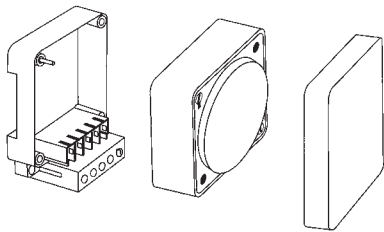

### MIL 72A D120

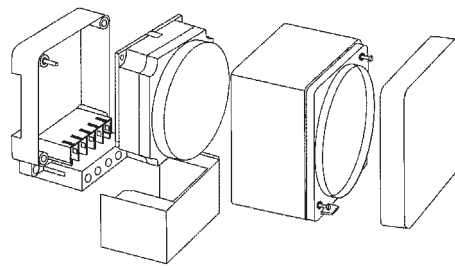

### MIL 72E D120

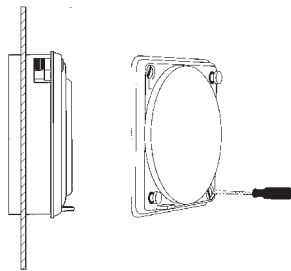

### MIL 72 D220

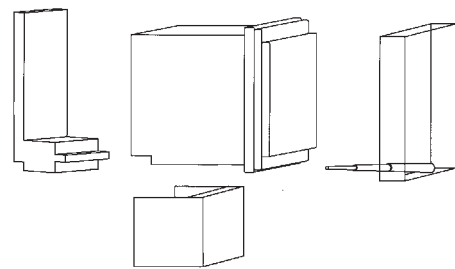

## Connection

MIL 72 D120  
MIL 72A D120  
MIL 72E D120  
FMD 120

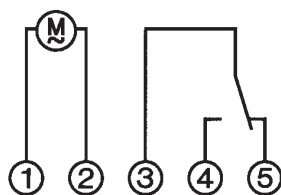

MIL 72 D220

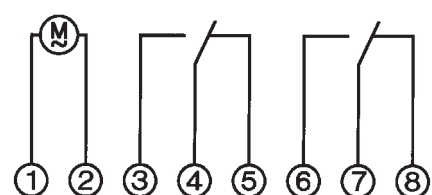



## Accessory

### MIL 72 D120

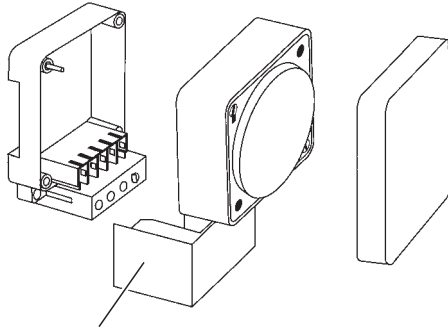

Terminal cover  
01.78.0004.6

### MIL 72E D120

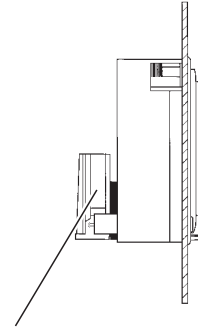

Flush mounting base  
01.79.0002.2

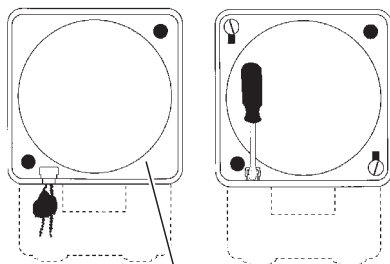

Sealing glass - IP40  
01.78.0021.6

### MIL 72 D220

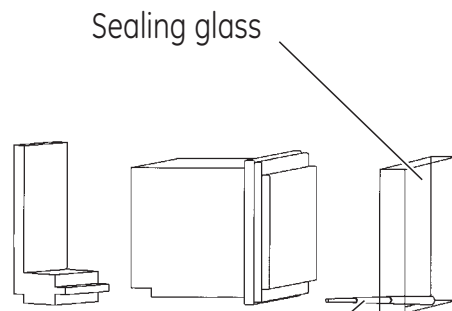

Sealing screw  
16.10.0011.8

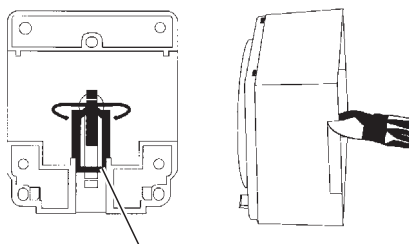

Multi-terminal busbar, latch  
01.78.0036.6

- : Overview of daily switching program
- 24hPM : Setting of 24h or am/pm
- +1h : Summer/winter clock changes
- ◀ : Weekday display
- ⊙ : Switching status display ON/OFF
- ☞ : Manual operation / fixed ON / fixed OFF
- ⌚ : Automatic operation

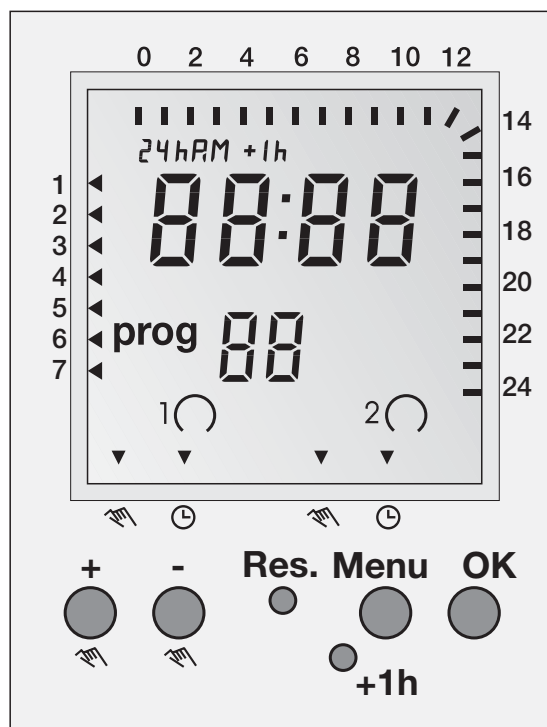

- +/- : Adjustment keys: By pressing the key longer than 2 sec. you can adjust the timer in steps of 5 units
- Res. : Reset
- Menu : By pressing the menu key programming is terminated and the system reverts to automatic operation
- OK : Confirmation of programming

Setting of this programmable timer is depending of the user preference to use pre-set programs or defining own programming.

### Using Pre-set programs (first time installation)

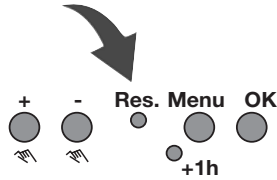

Using **Reset** key you can adjust the following values:

- 24h or am/pm: see pg 22
- Time (hour and minutes): see pg 23
- Week day: see pg 23
- Pre-set programs P01 to P03: see pg 24

### User defined programming by Menu mode

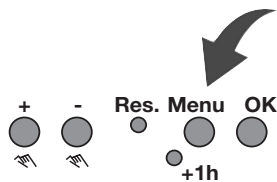

Using **Menu** key you can adjust / review the following values:

- 24h or am/pm: see pg 22
- Time (hour and minutes): see pg 23
- Week day: see pg 23
- Programs P--: see pg 24



Sequence to follow after selecting programming by pre-set programs or Menu mode.

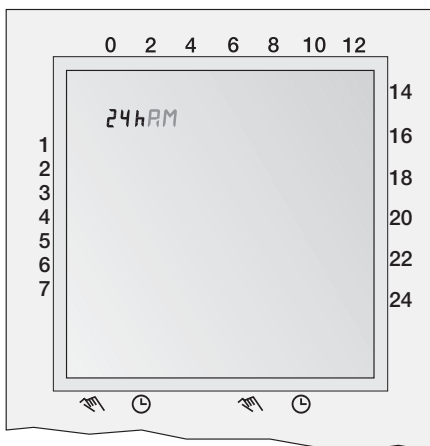

### Set display format 24h or am/pm

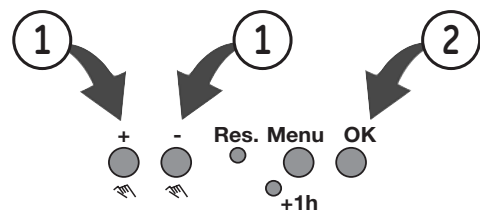

Select 24h or am/pm (+/-) and confirm with **OK**.

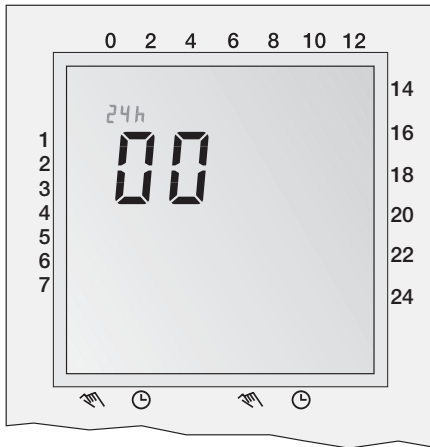

### Set hour

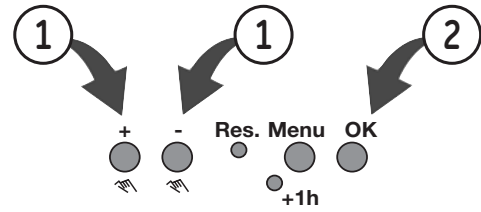

Select hour (+/-) and confirm with **OK**.



### Set minutes

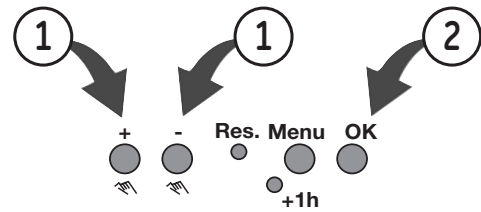

Select minutes (+/-) and confirm with **OK**.



### Set week day

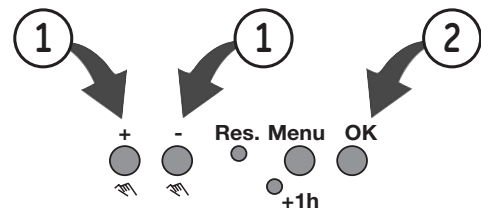

Select week day (+/-) and confirm with **OK**.

- |               |              |
|---------------|--------------|
| 1 = Monday    | 5 = Friday   |
| 2 = Tuesday   | 6 = Saturday |
| 3 = Wednesday | 7 = Sunday   |
| 4 = Thursday  |              |

**P01:** Mo - Su, 1 x ON/OFF



**P01:** Mo - Su, 2 x ON/OFF

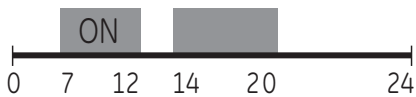

**P01:** Mo - Su, 3 x ON/OFF

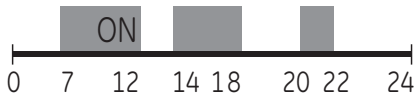

**Programs P01-03**

The switching on and off times for programs P01 to P03 are preset (pre).

The user can change these programs.

**Individual program, P--**

Under the menu option P-- you have the option of creating a user-defined program.

This program can be changed at any time.

There are up to 20 memory locations available for 10 OFF and 10 ON commands.

You can allocate a corresponding weekday or week block to each memory location.

**Note:**

For two channels version pre-set program is established in the two channels.



Sequence to follow after setting time in the Reset mode.

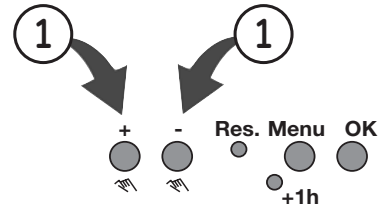

Select pre-set program (+/-).

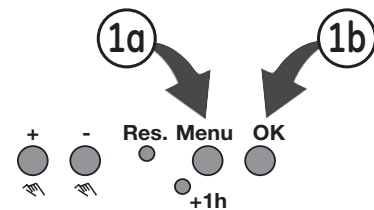

Once selected the program desired there are following options:

**Menu:** terminate programming

**OK:** Going through pre-set programs to modify selection (any program ON or OFF can be modified by using "+" or "-" keys and confirming with **OK**) or accept it with **OK** key to go the next free memory location in order to add new user defined programs (see pg 30).

e.g. after selecting P02 you should also program:

Sa-Su 22:30 ON (prog05)  
23:00 OFF (prog06)

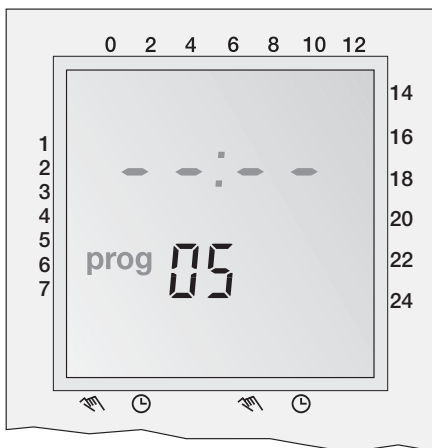

Sequence to follow after setting time and week day while running Menu mode or adding programs to the pre-set P01 to P03.

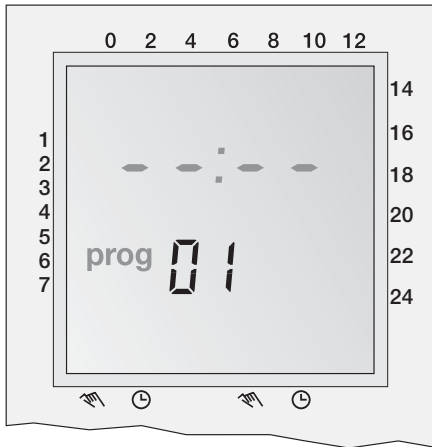

**Select program ON**

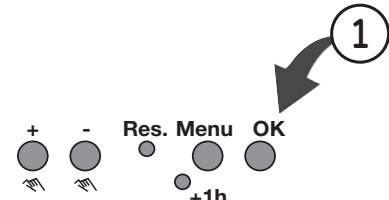

and confirm with **OK**.



**Set hour ON**

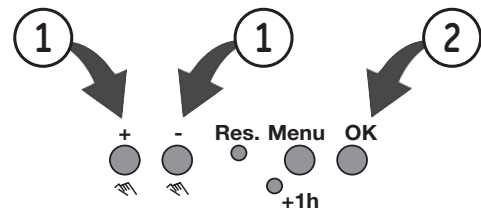

Select hour (+/-) and confirm with **OK**.



**Set minutes ON**

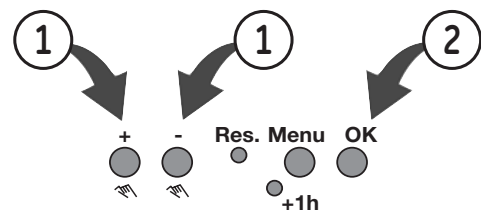

Select minutes (+/-) and confirm with **OK**.



### Set week day ON

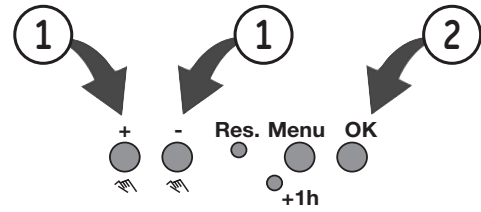

Select week day (+/-) and confirm with **OK**.

### Possible week blocks and individual days

	↓	↓	↓	↓	↓
1	◀	◀	◀		▶
2	◀	◀	◀		▶
3	◀	◀	◀		▶
4	◀	◀	◀		▶
5	◀	◀	◀		▶
6	◀	◀		◀	▶
7	◀			◀	▶



### Set Channel

(only for 2 Channel version)

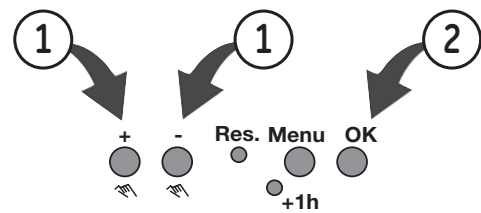

Select Ch1 or Ch2 (+/-) and confirm with **OK**.



### Set hour OFF

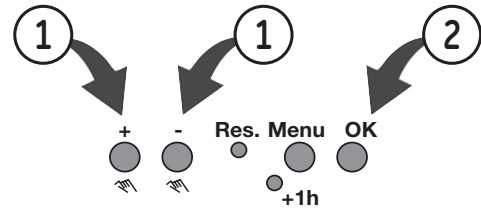

Select hour (+/-) and confirm with **OK**.



### Set minutes OFF

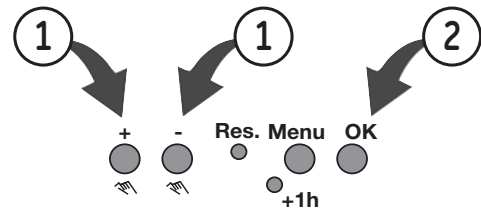

Select minutes (+/-) and confirm with **OK**.



### Set week day OFF

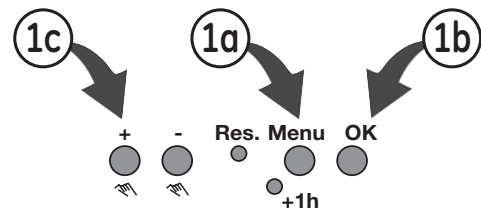

Should the OFF command be the same day of ON command then select **Menu** to terminate programming or select **OK** to go to a new program ON setting.

**Shift**

Should the OFF command be the following day of ON command then select "+" key then select **Menu** or **OK**.

Example:

**Mo-Fr**

20:00 p.m. - 03:00 a.m. ON  
03:00 a.m. - 20:00 p.m. OFF



**Mo-Fr**

20:00 p.m. - 03:00 a.m. ON

**Tu-Sa**

03:00 a.m. - 20:00 p.m. OFF

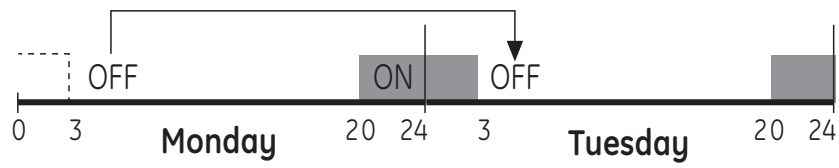

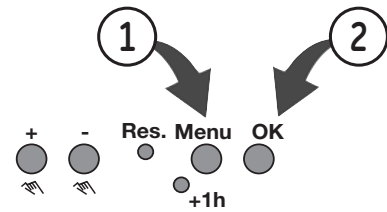

Select **Menu**, then select **OK** key until getting onto the ON time of the program you want to delete.

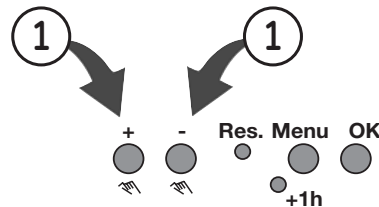

Select "--" with (+/-) key and confirm with **OK**.

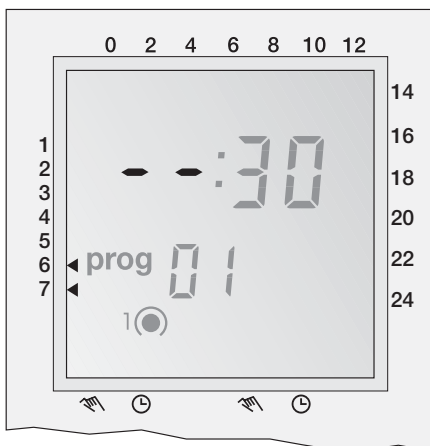

**Note:**

Switching programmes are deleted in ON-OFF pairs. If you delete a single ON instruction, the corresponding OFF instruction is also deleted.

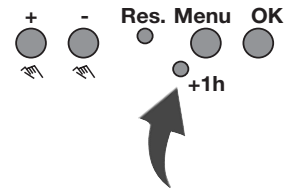

The **+1h** key is for the changeover from summer to winter time.

- By pressing the **+1h** key 1 hour is added to the current time.
- +1h is shown on the display.
- By pressing **+1h** again 1 hour is subtracted from the current time.

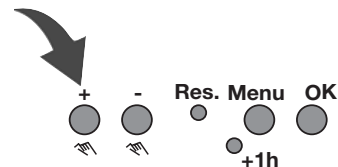

The "+" key serves to change over between automatic  $\odot$ , fixed ON  $\text{☞}$  and fixed OFF operations (Ch1).

The "-" key serves to change over between automatic  $\odot$ , fixed ON  $\text{☞}$  and fixed OFF operations (Ch2).