





EG 100

1 channel programmer weekly cycle

presentation

EG 100 programmer is equipped with 8 keys : 6 function keys, 1 selection key  to select 4 modes :

- time setting	
- programming	P
- display	
- automatic	A

as well as a yellow button  to erase (hours + programme) before commencing to program press this button.

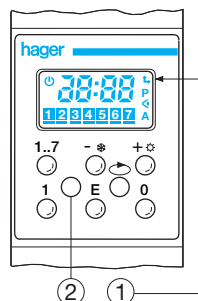

- ① mode selection
- ② reset

the selected mode is indicated by the symbol on the right of the LCD screen

2 alternatives to program :

- setting each day
- setting by grouping days in order to save programme steps, so a common instruction for several days conts only as 1 programme step

time setting

this mode allows :

- day setting
- time setting

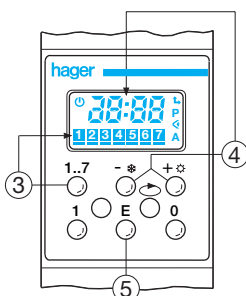

- ③ day setting
- ④ hour setting
- ⑤ enter

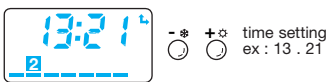

programming mode **P**

this mode allows 2 alternatives of programming :

- each day
- groups of day (common instruction for several days)

a memorised programme can be changed by adding, changing or by cancelling an instruction (display mode allows those modifications)

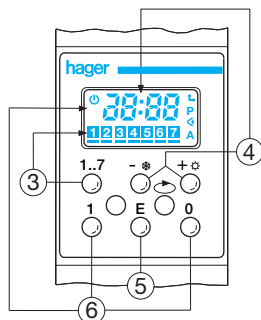

- ③ day setting
- ④ programming of instruction
- ⑤ enter
- ⑥ override start / stop

example of programming

heating system switching on Monday, Tuesday, Thursday, Friday from 7 . 30 to 9 . 00 and from 21 . 00 to 22 . 00

before programming these instructions group the days

a. to group days : «Monday, Tuesday, Tuesday, Friday»



 selection of programme setting



 storage of Monday



 Tuesday setting



 storage of Tuesday

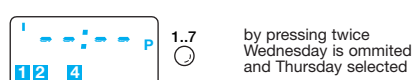

 by pressing twice Wednesday is omitted and Thursday selected

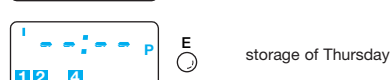

 storage of Thursday



 Friday setting



 storage of Friday

b. entering instructions



 setting of the time 7 . 30



 enter



 setting of the time 9 . 00



 enter

for the other instruction of the grouping days Mon., Tues., Thurs., Fri., proceed as before i.e. set «+» or «-», and enter «E» to select another day, press «1..7»



 return to auto-mode press device

add an instruction



 select programme setting, for your example : display of the 1st instruction of the grouped days Mon., Tues., Thurs., Fri.,



 go to a free programming step by pressing «E»

select state of the instruction «I» ou «O», and record it «E» ; for setting an other day press «1..7»

display mode ◀

this mode allows :

- to check a programme
- to change an existing programme by modification of an instruction, cancellation of an instruction

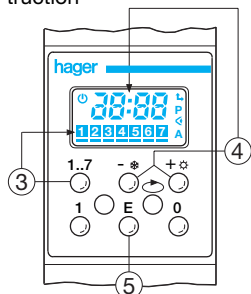

- ③ selection of days
- ④ modification or cancellation of instructions
- ⑤ enter

checking the programme



modify an instruction

example : modify the time 21 . 00

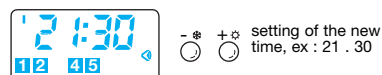
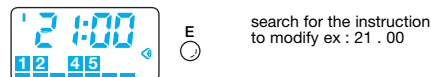

cancel an instruction

example : cancel the instruction 9 . 00

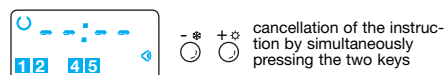

auto-mode A

this is the normal operating mode of the device :

this mode allows :

- summer / winter time setting
- manual override of the output state :
- return to the auto-mode, permanent override

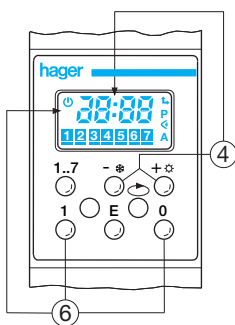

- ④ summer / winter time setting
- ⑥ override on I, override off O



summer / winter time setting

ex : action at 13 . 30

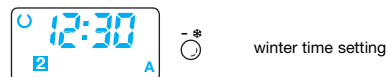

manual override

by pressing on « I » or « O »

display :
- the flashing symbols I and O correspond to a temporary override

example : heating system on from 7 . 30

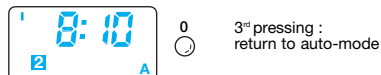
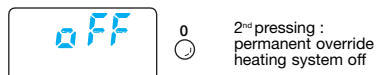
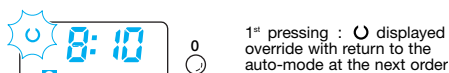

wiring

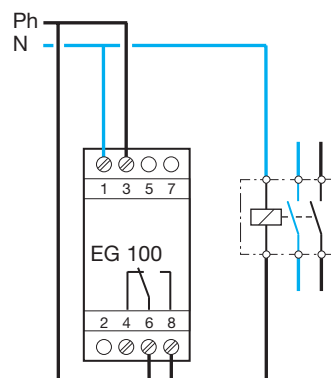

technical specifications

electrical characteristics :

- voltage rating : 230 V~ 50/60 Hz
- consumption : 4 VA
- output : 1 changeover contact
16 A-250 V~ AC1
1 A-250 V~ incandescent lamps

functional characteristics :

- programming capacity : 24 programme steps
- programming setting : 1 minute increments
- accuracy : ± 5min./annum
- supply failure reserve : 24 h
- no loss of programme in event of unlimited power failure.

environment :

- working temperature :
-5° C to + 45° C
- storage temperature :
-20° C to + 60° C

connection capacity :

- flexible : 1 to 6^{sq}
- rigid : 1,5 to 10^{sq}

warranty

A warranty period of 24 months is offered on hager products, from date of manufacture, relating to any material of manufacturing defect. If any product is found to be defective it must be returned via the installer and supplier (wholesaler). The warranty is withdrawn if :

- after inspection by hager quality control dept the device is found to have been installed in a manner which is contrary to IEE wiring regulations and accepted practice within the industry at the time of installation.
- the procedure for the return of goods has not been followed. Explanation of defect must be included when returning goods.