

TORK MODEL 8061 6 MINUTE REPEATING TIMER

SWITCH: SPDT

CONTACT RATINGS:

20 AMP 120/240VAC

3/4HP 120VAC;

1-1/2HP 240VAC

TIMING MOTOR:

120VAC 60Hz

POWER CONSUMPTION:

3 WATTS MAX.

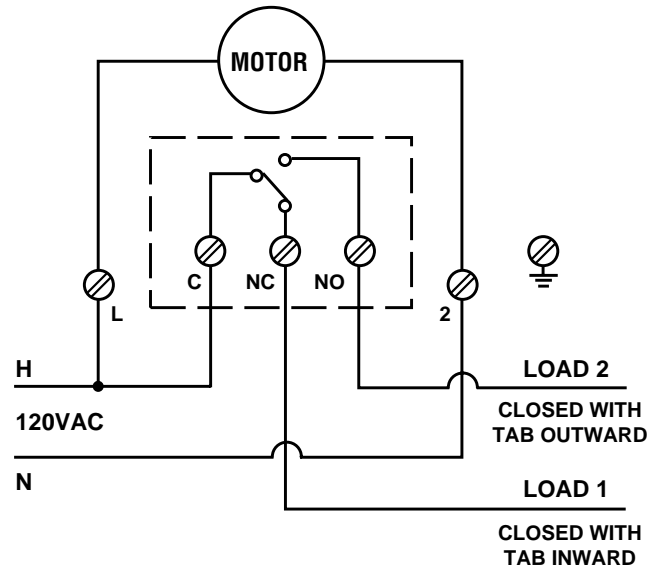

Disconnect power at main panel prior to installing or servicing this time switch or the equipment connected to it.

Connect in accordance with national and local electrical codes.

Supply Connections: Use gauge specified (AWG # 8-14) suitable for 75 degrees C (167 degrees F)

INSTALLATION AND OPERATING INSTRUCTIONS

TO SET OPERATING TIMES: Each dial tab represents approximately 6 seconds. These tabs can be tilted in and out with the fingers.

FOR OFF OPERATION: Tilt tabs outward as illustrated in figure 1. Tilt out one tab for each 6 second period. This closes load 2 and opens load 1.

Fig. 1

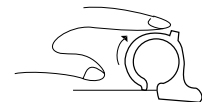

FOR ON OPERATION: Tilt tabs inward toward center of dial, as illustrated in figure 2. This closes load 1 and opens load 2.

Fig. 2



TO REMOVE MECHANISM FROM CASE: Press lever near case latch to release mainplate and swing the movement out. To replace, insert mainplate projections in slots opposite latch and swing movement in until it latches.