

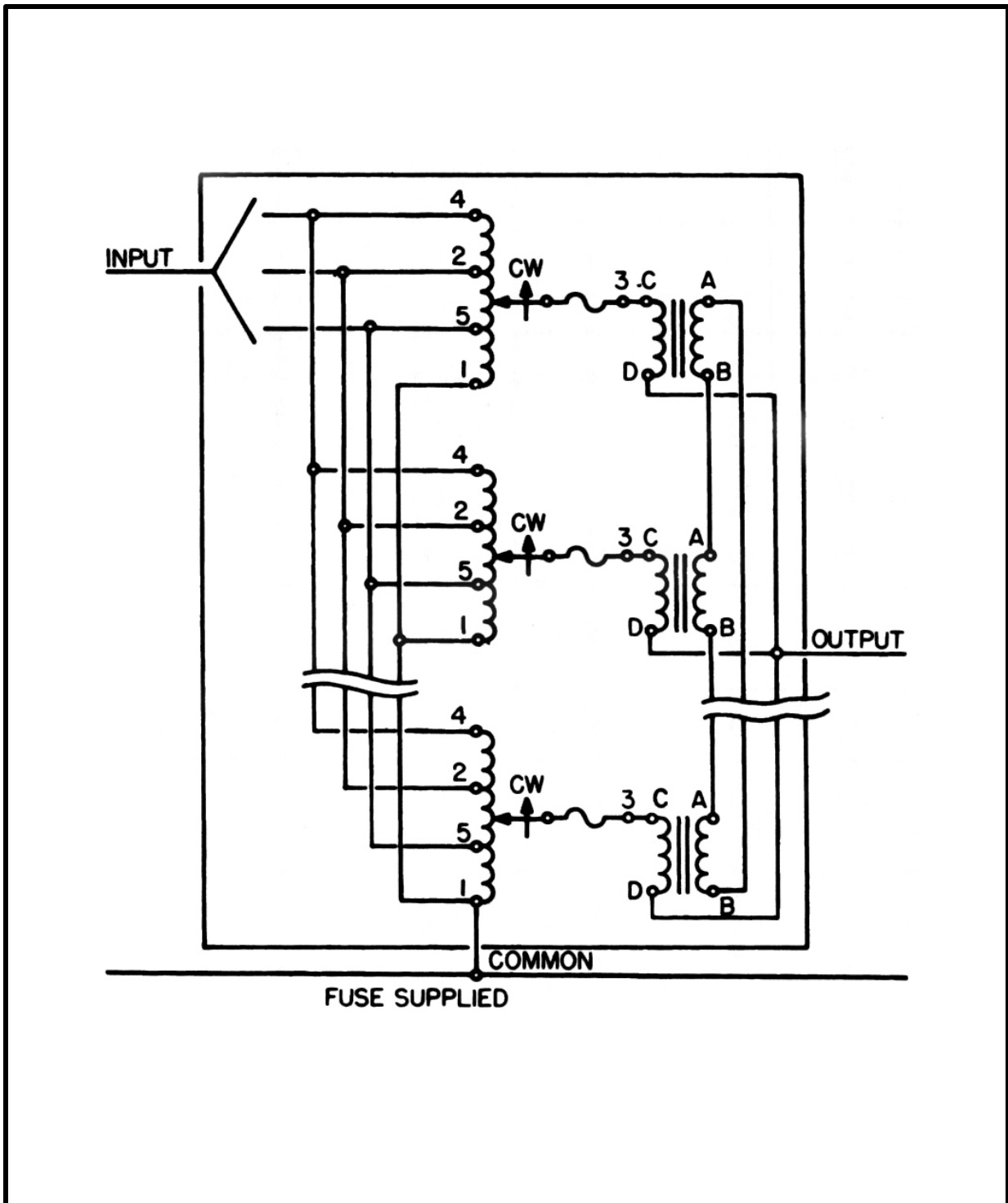

Variable Transformers Schematics & Wiring Diagrams



Schematics and Wiring Diagrams

General Wiring Information

Common is used as the third leg in a three phase open delta or as neutral in a three wire single phase series and four wire, three phase wye connection. It is not used in two wire series or three wire wye connection.

If ganged units are used in a system that ordinarily has a common neutral or ground between source and load, the neutral or ground must be connected to the common terminals of the variable transformer assembly. If the system has no neutral, the load must be balanced or the transformers will be damaged.

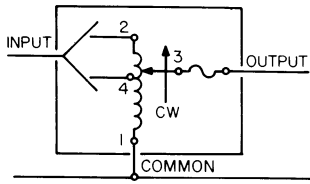

FUSE RECOMMENDED BUT NOT SUPPLIED

1

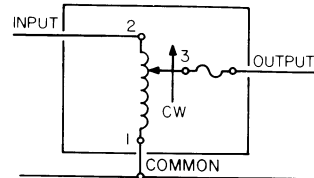

FUSE RECOMMENDED BUT NOT SUPPLIED

2

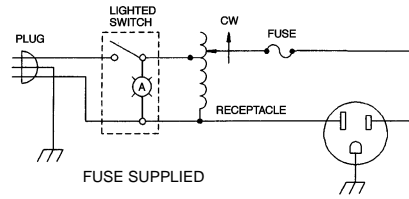

FUSE SUPPLIED

3

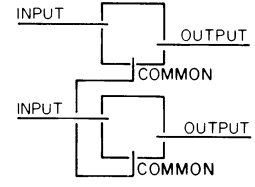

SERIES

4

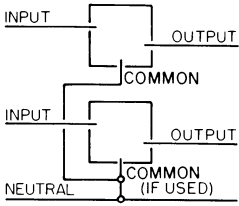

THREE PHASE OPEN DELTA

5

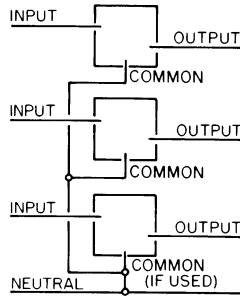

THREE PHASE WYE

6

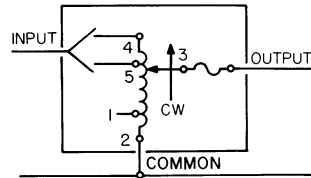

FUSE RECOMMENDED BUT NOT SUPPLIED.

7

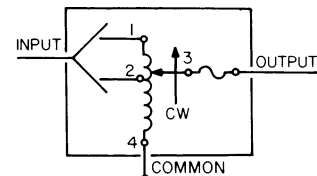

FUSE RECOMMENDED BUT NOT SUPPLIED

8

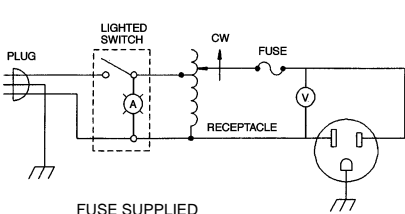

FUSE SUPPLIED

9

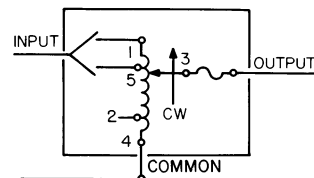

FUSE RECOMMENDED BUT NOT SUPPLIED.

10

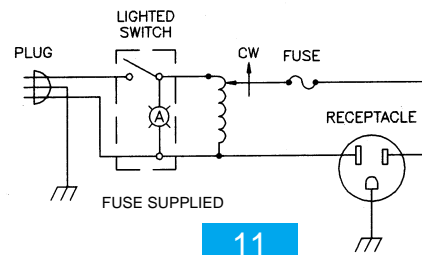

FUSE SUPPLIED

11

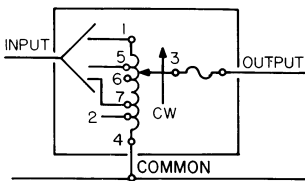

FUSE RECOMMENDED BUT NOT SUPPLIED.

12

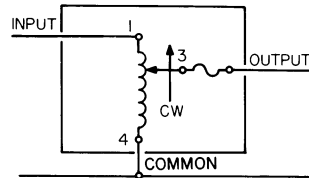

FUSE RECOMMENDED BUT NOT SUPPLIED.

13

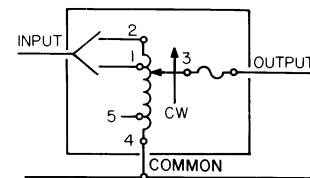

FUSE RECOMMENDED BUT NOT SUPPLIED.

14

Schematics and Wiring Diagrams

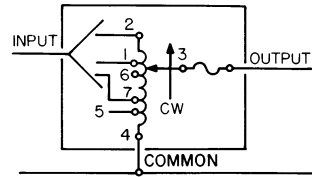

FUSE RECOMMENDED BUT NOT SUPPLIED.

15

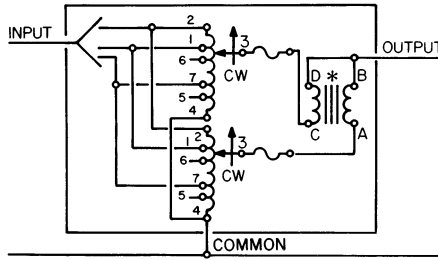

* PARALLELING CHOKE FOR 2510=51LAC
* PARALLELING CHOKE FOR 2520=52LAC
TERMINALS #6 AND #7 OMITTED ON 2510
FUSE RECOMMENDED BUT NOT SUPPLIED.

16

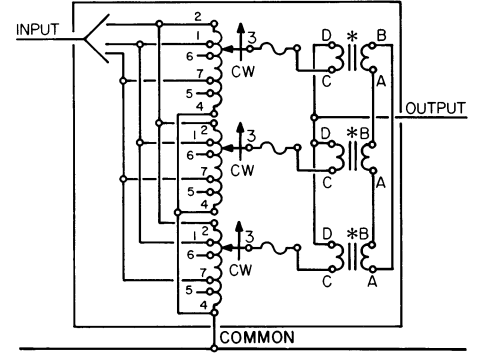

* PARALLELING CHOKE FOR 2510=51LAC
* PARALLELING CHOKE FOR 2520=52LAC
TERMINALS #6 AND #7 OMITTED ON 2510
FUSE RECOMMENDED BUT NOT SUPPLIED.

17

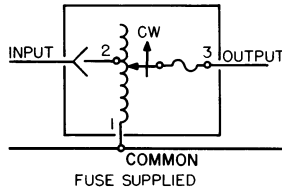

FUSE SUPPLIED

18

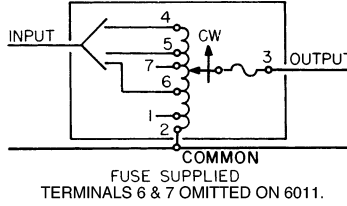

FUSE SUPPLIED
TERMINALS 6 & 7 OMITTED ON 6011.

19

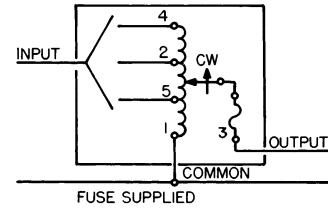

FUSE SUPPLIED

Terminals 4 and 5 omitted on 5011 Series
Terminal 5 omitted on 6011 Series

20

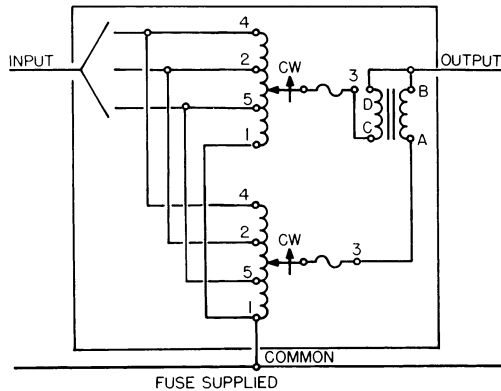

Terminals 4 and 5 omitted on 5011 Series
Terminal 5 omitted on 6011 Series

21

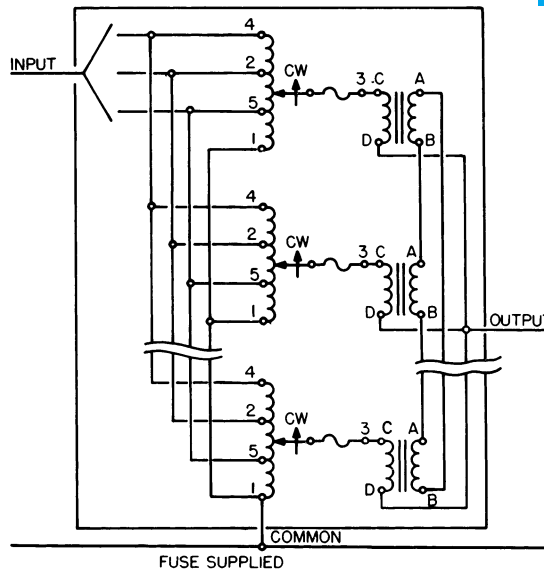

FUSE SUPPLIED
Terminals 4 and 5 omitted on 5011 Series
Terminal 5 omitted on 6011 Series

22

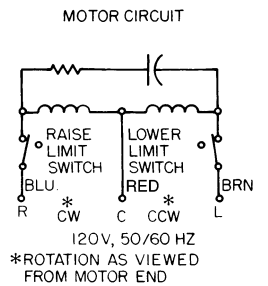

23