

Today's home and business owners want optimum control of their electrical systems. P&S Dimmers & Fan Speed Controls provide that control — along with aesthetics, durability, trouble-free installation, and innovative technologies.



Benefits of Using Pass & Seymour/Legrand Dimming

Save Energy – Dimming reduces the amount of energy consumed by the lamps which reduces energy costs.

Add ambience – Change the lighting to set the mood or highlight the décor.

Add comfort – Use only the light you need for the task.

Add flexibility – Change the look of the room and then change it back. Quickly and easily.

Add convenience – Presets and scene controls make it easy to set up your home the way you like with accuracy and repeatability.

Increase safety and security – Never drive up to a dark house again.

Lower maintenance costs – Dimming increases the life of incandescent lamps.

Add value – A home with lighting controls is worth more.

Index

Device	Page Number
Product Selection Guide	N-2
Catalog Numbering System	N-3
Residential Dimmers & Fan Speed Controls	
LightSense™	N-4 – N-10, N-37
Scene Director	N-11, N-12, N-38
Leandro®	N-13, N-38
Harmony™	N-14, N-38
TradeMaster® Short Slide	N-21, N-40
TogglePlus	N-22
TradeMaster® Toggles	N-23, N-40
Rotary R Series	N-24
Residential & Light Commercial Dimmers & Fan Speed Controls	
LS Series	N-15 – N-17, N-39
DR Series	N-18, N-38
Wide Slide Series	N-19, N-20, N-40
Rotary Series	N-25
Rotary Fan Speed Controls	N-26, N-41
Commercial Dimmers & Fan Speed Controls	
Titan™ Series	N-27 – N-34, N-42
Rotary Dimmers	N-35
Rotary Fan Speed Controls	N-36, N-43

Dimmers & Fan Speed Controls Product Selection Guide



Energy concerns have created directives in some states for lighting controls in new residential construction and major renovations. In an effort to reduce electrical power consumption, California has mandated one of the most stringent energy codes in the country. California Title 24 requires high efficacy luminaires, vacancy sensors (Section M), or dimmers to be placed in certain areas of the home. The standard became effective on October 1, 2005. Other states are considering adopting similar mandates to answer their own energy concerns. Pass & Seymour/Legrand has an extensive selection of vacancy sensor and dimmer solutions to address this growing industry trend.



LightSense™ Control

- Select any lighting scene at the touch of a button – for a room, an area, or the entire home.
- Reliable radio-control operation.
- For added security – with a repeater, the system will play back lighting usage from previous week for a realistic everyone's-at-home appearance.

PAGE N-4 – N-10



Scene Director Control

- Select any lighting scene at the touch of a button.
- Optional infrared remote enables control from anywhere in the room.
- Master can control up to 30 dimmers.
- Easy to program – and won't lose programming during power outage.

PAGE N-11, N-12



Leandro® Decorator Dimmers

- Multi-location dimming.
- Light levels fade elegantly up/down.
- Green LEDs indicate preset level; red LED makes dimmers easy to find in the dark.

PAGE N-13



Harmony™ Decorator Dimmers

- Matches P&S Decorator devices.
- Combines ON/OFF Decorator switch with separate slider for dimming control.
- No lost settings during power outages.

PAGE N-14



LS Series Decorator Slide Dimmers

- Smooth, ergonomic operation.
- Snap-in LED light modules make dimmers easy to find at night.
- Available in both preset and non-preset models.

PAGE N-15 – N-17



DR Series Decorator Rotary Dimmers

- Illuminated knob shows light level.
- Snap-in LED light modules make dimmers easy to find at night.
- Available for incandescent and low-voltage lighting.

PAGE N-18



TogglePlus Dimmers

- Convenient preset dimming control.
- Lights come on gradually – easy on the eyes and the lamps.
- Matches appearance of toggle switches.

PAGE N-22



Toggle Dimmers

- Match appearance of toggle switches.
- No loss of settings during power outages.
- Illuminated versions available.

PAGE N-23



Short Slide Dimmers

- Provide a contemporary style using a toggle-style wall plate.
- Retain settings through power outages.

PAGE N-21



Rotary Dimmers

- Models for incandescent and low-voltage lights; preset and illuminated features available.
- Simple to operate.

PAGE N-24

Dimmers & Fan Speed Controls Catalog Numbering System

Pass & Seymour



All Pass & Seymour Dimmers and Fan Speed Controls use an easy-to-understand catalog numbering system:

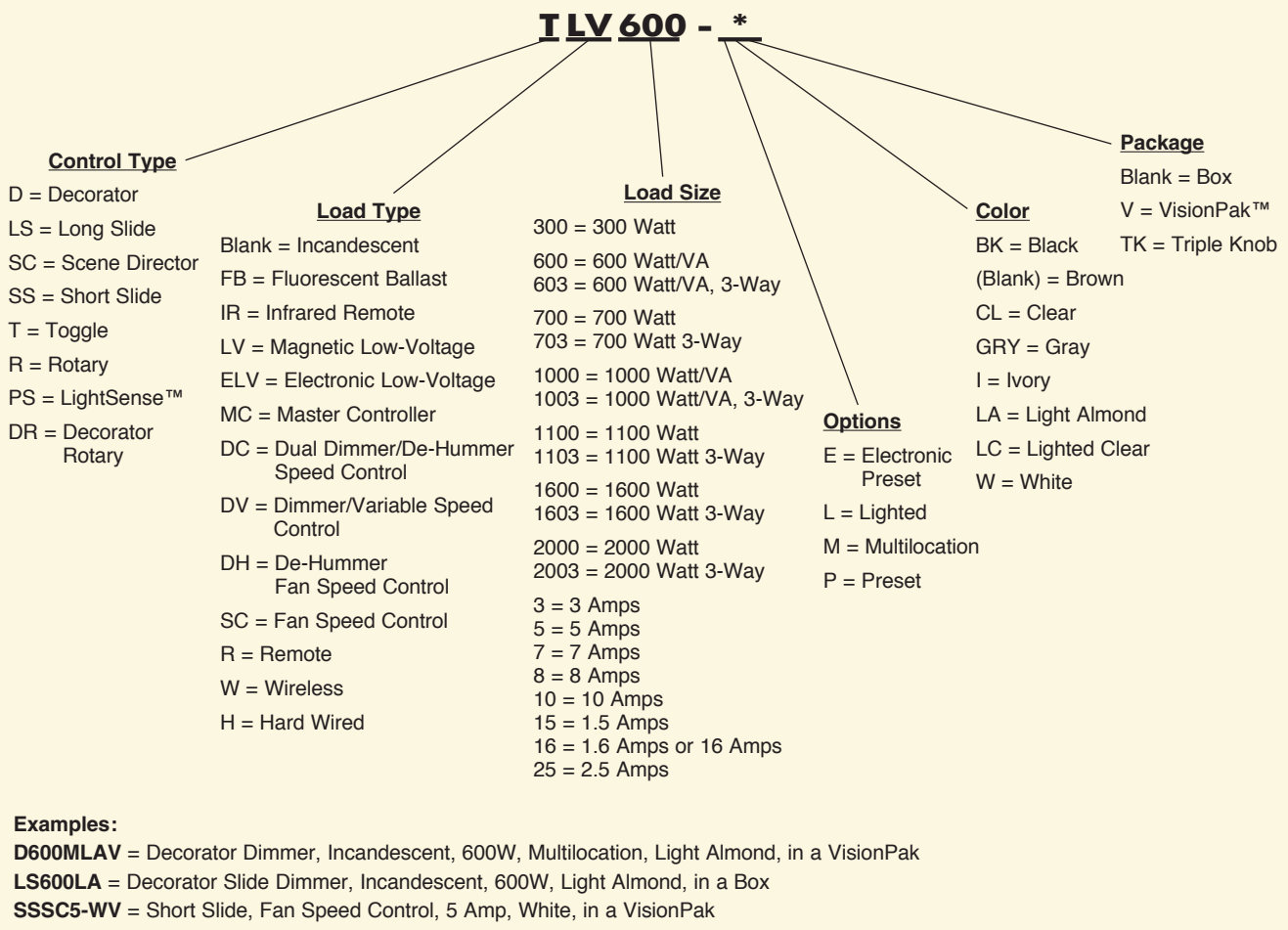

Many P&S Dimmers & Fan Speed Controls are available boxed or VisionPak™ clam-shell packaging for high-impact merchandising. Please see the Catalog Numbering System above or specific charts for ordering information.

Pass & Seymour



Residential Dimmers & Fan Speed Controls LightSense™ Wireless Control



Wireless LightSense is a lighting control system that is great for new and retrofit installations.

Wireless LightSense delivers convenient, easy-to-use control:

- one-touch whole house ON/OFF
- whole house and room scene control
- sophisticated, frequency-agile Radio Frequency (RF) wireless communications technology
- PANIC alerts and vacation mode
- integration with other home automation devices and systems
- coordinated control of lamps, ceiling fans, and small appliances
- cULus approved, 5-year warranty
- system range 80' without repeaters
- up to 2 repeaters can be added to extend the range to 300'
- maximum 1023 devices per house
- maximum 127 room controls per house
- maximum 10 whole house scenes
- maximum 15 scenes per room

For complete information on LightSense, reference the following P&S literature:

Specification & Design Guide (part no. BR1579)

Installation Guide (part no. FY1623)

Consumer Literature Brochure (part no. BR1577)

Or contact your local P&S sales representative or visit us online at www.passandseymour.com



Residential Dimmers & Fan Speed Controls LightSense™ RF Wireless Master & Hand Held Controllers

Pass & Seymour



Features

- No control wiring necessary.
 - Topdog™ RF communication protocol; 900MHz radio, bidirectional.
 - Recalls scene information stored in the dimmers and switches.
 - Configuration lock prevents unwanted tampering with programmed scenes.
 - Includes preprinted scene labels.
 - Fits within standard wallbox.
 - Compatible with Decorator wall plates.
 - 5-year warranty.
- PSWCH**
- Program and recall 5 house scenes, two sets of scenes.
- PSWCR**
- Program and recall 5 room scenes, three sets of scenes.

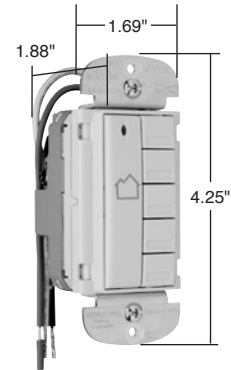

PSWCHLA

PSWCH/PSWCR
Wiring Diagram

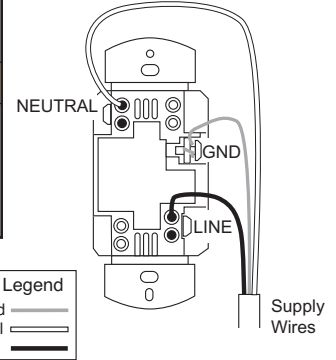

Catalog Number	Description	Ratings	Color
NEW Wall Mount Wireless Whole House Scene Master Controllers			
PSWCHI PSWCHW PSWCHBK PSWCHLA	RF Wireless House Scene Controllers	120V	Ivory White Light Almond Black
NEW Wall Mount Wireless Room Scene Master Controllers			
PSWCRI PSWCRW PSWCRBK PSWCRLA	RF Wireless Room Scene Controllers	120V	Ivory White Black Light Almond

Description

Whole house hand held scene control allows the set up, recording, and recall of up to 10 scenes. For added safety and security includes the panic function.

Catalog Number	Description	Color
NEW Wireless Hand Held Whole House Controller		
PSWRH	House scene hand held remote control Includes 3 AAA alkaline batteries and wall holder	Black

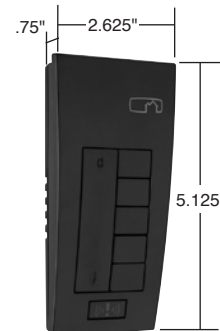

PSWRH

Description

Room scene control allows the set up and playback of light levels on the LightSense devices bound to the control. Seek feature provides individual control of each load in the room.

Catalog Number	Description	Color
NEW Wireless Hand Held Room Controller		
PSWRR	Room scene hand held remote control Includes 3 AAA alkaline batteries and wall holder	Black

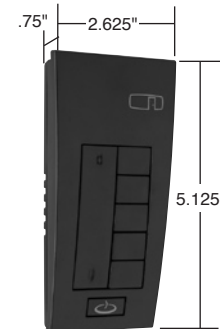

PSWRR

For more information about LightSense™ layout and programming, consult the Specification & Design Guide (part no. BR1579) and the Wireless Installation Guide (part no. FY1623).

All devices listed on this page conform to NEMA WD-1 and WD-6. cULus Listed.

Pass & Seymour



Residential Dimmers & Fan Speed Controls LightSense™ RF Wireless Dimmers & Plug-In Modules

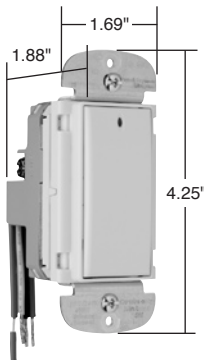

PSWDILA
PSWDULA

Features

- No control wiring necessary.
 - Topdog™ RF communication protocol; 900MHz radio, bidirectional.
 - Large surface-mounted antenna ensures maximum broadcast coverage.
 - Ability to recall last lighting level (preset).
 - Stores room and house scenes.
 - Support PANIC mode operation.
 - Default fade rate (two seconds).
 - Square law dimming curve.
 - Soft start technology significantly extends lamp life by limiting inrush current.
 - Power failure restore to last-used level.
 - Compatible with Decorator wall plates.
 - Patented overload and short circuit protection.
 - Dimmers must be de-rated when ganged or when used with non-incandescent loads.
 - 5-year warranty.
- PSWDI**
- No neutral required.
- PSWDU**
- Neutral required.
 - Incandescent, MLV, ELV, and Advance MK 10 dimmable fluorescent ballasts.

Catalog Number	Description	Voltage	Min. Watt	Max. Watt	Load	Color
NEW Incandescent Wireless Dimmers						
PSWDII PSWDIW PSWDIBK PSWDILA	RF Wireless Multi-Location Dimmer	120V	60W	600W	Incandescent Only	Ivory White Black Light Almond
NEW Universal Wireless Dimmers						
PSWDUI PSWDUW PSWDUBK PSWDULA	RF Wireless Universal Dimmer	120V	25W	600W	All	Ivory White Black Light Almond

PSWDI Wiring Diagram

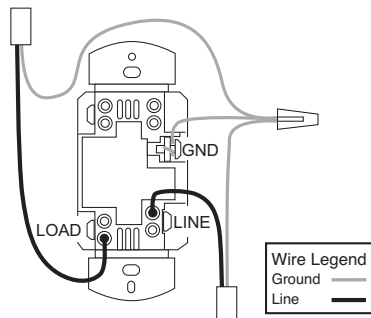

PSWDU Wiring Diagram

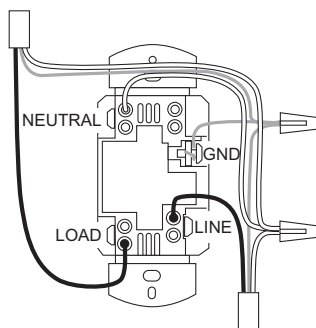

Mounting dimmers in deep electrical boxes is recommended.

For de-rating chart, see Page N-10.

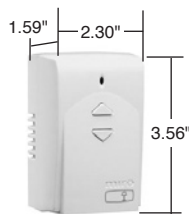

PSWPL

Features

- Plugs into any grounded, 120V outlet.
- Auto-ON feature ensures load receives power if occupant turns switch ON manually.

Catalog Number	Description	Voltage	Wattage	Color
NEW Wireless Plug-In Modules				
PSWPL	Table Lamp Dimming Module	120V	300W	White
PSWPA	Small Appliance Switching Module	120V	800W	White

For more information about LightSense™ layout and programming, consult the Specification & Design Guide (part no. BR1579) and the Wireless Installation Guide (part no. FY1623).

Residential Dimmers & Fan Speed Controls LightSense™ RF Wireless Switches, Fan Speed Controls & Controllers

Pass & Seymour



Features

- No control wiring necessary.
 - Topdog™ RF communication protocol; 900MHz radio, bidirectional.
 - Large surface-mounted antenna ensures maximum broadcast coverage.
 - Stores room and house scenes.
 - Neutral required.
 - Power failure restore to last used level.
 - Patented overload and short circuit protection.
 - Compatible with Decorator wall plates.
 - 5-year warranty.
- PSWS**
- Switches support PANIC mode operation.
- PSWCF**
- Fan speed controls provide previous speed recall (preset).

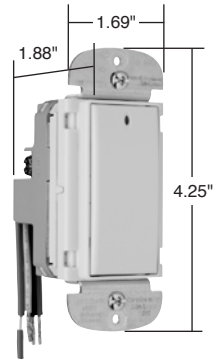

PSWSLA

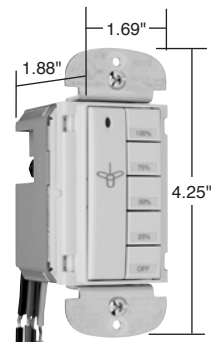

PSWCFLA

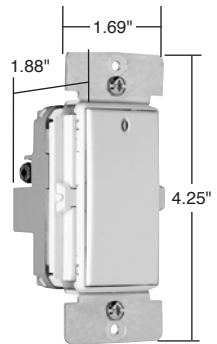

PSWCSLA

PSWCSL Wiring Diagram

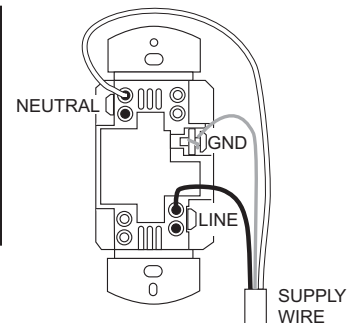

Catalog Number	Description	Voltage	Max. Watt	Load	Color
NEW Universal Wireless Switches					
PSWSI PSWSW PSWSBK PSWSLA	RF Wireless Universal Switch	120V	800W	Lighting, 1/8 hp motor	Ivory White Black Light Almond
NEW Wireless De-Hummer* Fan Speed Controls					
PSWCFI PSWCFW PSWCFBK PSWCFLA	RF Wireless Fan Speed Control	120V	—	1.5A	Ivory White Black Light Almond

* Feature specially designed capacitive circuitry to virtually eliminate fan motor "hum."

PSWS Wiring Diagram

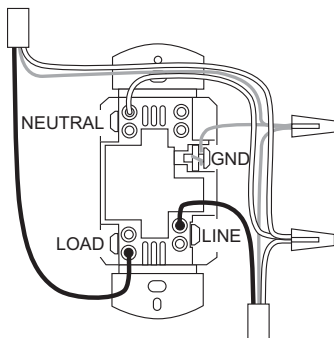

PSWCF Wiring Diagram

Mounting controls in deep electrical boxes is recommended.

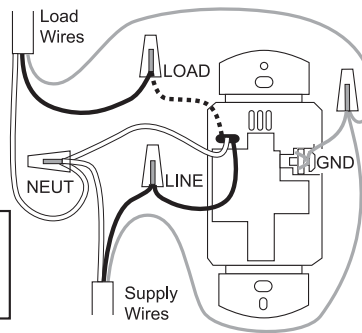
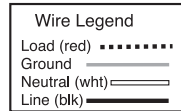

Features

- Can raise/lower grouped lighting level.
- Controls dimmers, switches, and fan speeds from multiple locations.

Catalog Number	Description	Voltage	Color
NEW Multi-Location Wireless Controller Switches			
PSWCSI PSWCSW PSWCSBK PSWCSLA	RF Wireless Accessory Controller	120V	Ivory White Black Light Almond

For more information about LightSense™ layout and programming, consult the Specification & Design Guide (part no. BR1579) and the Wireless Installation Guide (part no. FY1623).

All devices listed on this page conform to NEMA WD-1 and WD-6. cULus Listed.

Pass & Seymour



Residential Dimmers & Fan Speed Controls

LightSense™ RF Wireless

2000 Watt Dimmer & Keyfob

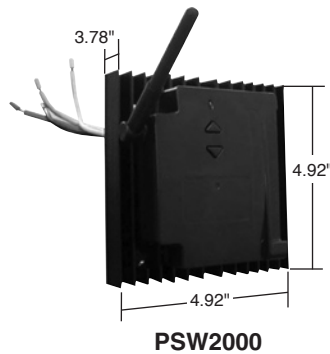

Features

- Topdog™ RF communication protocol; 900MHz radio, bidirectional.
- Compatible with most load types.
- Linear dimming of fluorescent loads.
- Last level recall (preset).
- Stores room and house scenes.
- Supports PANIC mode operation through House Scene Controller.
- Default fade rate fades lighting OFF (two seconds).
- Long life status LED.
- Power failure restore to last-used level.
- Soft start technology significantly extends lamp life by limiting inrush current.
- Wall, plenum, or semi-recess mountable.
- Neutral required.
- Plenum rated.
- Normally open air-gap relay at load output.
- Temperature: 32-104°F (0-40°C).
- Humidity: 0-95%, non-condensing.
- 5-year warranty.

Catalog Number	Description	Voltage	Wattage	Color
NEW PSW2000	Wireless High-Wattage Dimmer			
PSW2000	RF Wireless Dimmer Module	120/277V	See Chart Below	Black

PSW2000 Wiring Diagram

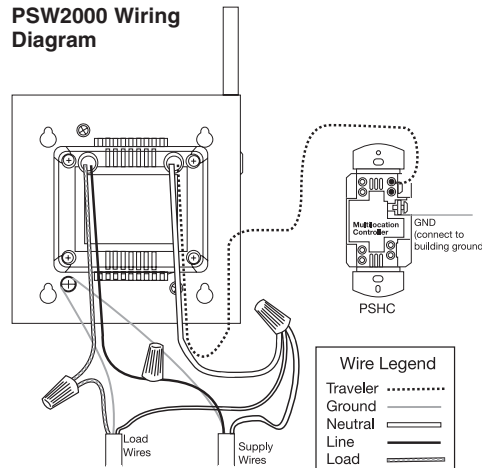

A PSW2000 dimmer is compatible with wired LightSense devices, as shown here. It will also communicate with a wireless RF LightSense network.

PSW2000 Mounting Diagram

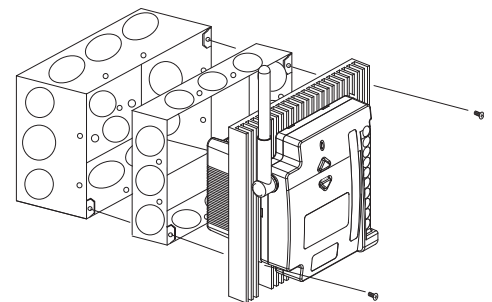

Mount the PSW2000 dimmer vertically and provide 6" clearance above and below the dimmer for airflow. Requires 100 BTW/hour ventilation. Backbox (4" x 2-1/8") may be surface or recess mounted. Extension (1-1/2") must extend out from the wall.

Load Type	120V	120V	277V	277V
	Minimum Load	Maximum Load	Minimum Load	Maximum Load
Incandescent/quartz halogen	100W	2000W	—	—
Magnetic low voltage	100VA	2000VA	200VA	4432VA
Electronic low voltage	100VA	2000VA	—	—
Neon/cold-cathode	100VA	2000VA	—	—
Two-wire fluorescent (linear or compact, Advance Mark X or equivalent)	100VA	2000VA	200VA	4432VA



Catalog Number	Description	Color
NEW PSWKEYFOB	Wireless Keyfob Control	
PSWKEYFOB	RF Wireless Keyfob Preset Control, CR2450 battery & visor clip included	Black

For more information about LightSense™ layout and programming, consult the Specification & Design Guide (part no. BR1579) and the Wireless Installation Guide (part no. FY1623).

All devices listed on this page conform to NEMA WD-1 and WD-6. UL Listed and CSA Certified.

Residential Dimmers & Fan Speed Controls LightSense™ RF Wireless Repeater & Interfaces

Pass & Seymour



Features

- Network supports up to two repeaters.
- Increases effective range up to 100 ft. per repeater.
- Occupancy emulation for security.
- Topdog™ RF communication protocol; 900MHz radio, bidirectional.
- No control wiring necessary.
- Neutral required.
- Temperature: 32-104°F (0-40°C).
- Humidity: 0-80%, non-condensing.
- 5-year warranty.

Catalog Number	Description	Voltage	Color
Wireless Repeater			
PSWO	RF Wireless Repeater with Home/Away settings	120V	Charcoal Gray



PSWO

Features – PSWIH, PSWIR, PSWC232

- Network supports unlimited number of modules.
 - Topdog™ RF communication protocol; 900MHz radio, bidirectional.
 - No network control wiring necessary.
 - Two operating modes (maintained or momentary type inputs).
 - Three inputs accessing up to six functions.
 - 200mA 24V power supply.
 - Two-wire interface from other control systems.
 - Source terminals to power external equipment (150mA).
 - Removable screw terminals.
 - Temperature: 32-104°F (0-40°C).
 - Humidity: 0-80%, non-condensing.
 - cULus listed.
 - 5-year warranty.
- PSWIH, PSWIR**
- Power supply (included) 12-24VDC.
 - Inputs: limited low-voltage (3-24VDC).
- PSWC232**
- Power supply (included) 9-12VDC.
 - Input 9-12VDC, 50mA minimum.
 - Output 9VDC, 50mA.

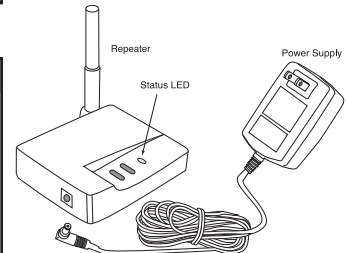

PSWO Product Controls

The wireless repeater easily plugs into any standard outlet. It is best installed in a central location.

Description – PSWIH, PSWIR

Wireless LightSense™ scene interfaces provide an interface between a LightSense network and other home automation devices. Typically, a module will be located near the external device (i.e., time clock) with which it is interfaced.

Multiple LightSense scene interface modules may be used in a LightSense network.

Catalog Number	Description	Voltage	Color
Wireless Scene Interfaces			
PSWIH	RF Wireless Whole House Switch Closure Interface	120V	Charcoal Gray
PSWIR	RF Wireless Room Switch Closure Interface	120V	Charcoal Gray



PSWIH
PSWIR

Description – PSWC232

The PSWC232 network controller provides convenient interconnectivity between a wireless LightSense™ lighting control system and other home automation systems, such as multimedia and home theater controls. With the device, homeowners can transmit control commands to the LightSense lighting network via most automation system devices.

Catalog Number	Description	Voltage	Color
Wireless Network Controller			
PSWC232	RF Wireless RS232 Network Controller Interface Communicates via standard ASCII communication protocol	120V	Charcoal Gray

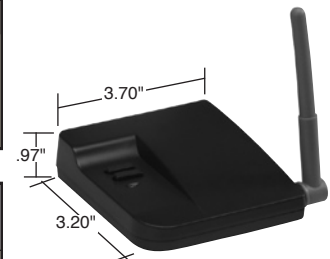

PSWC232

For more information about LightSense™ layout and programming, consult the Specification & Design Guide (part no. BR1579) and the Wireless Installation Guide (part no. FY1623).

All devices listed on this page conform to NEMA WD-1 and WD-6. UL Listed.

Pass & Seymour

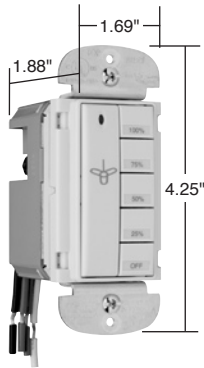

PSHCFLA

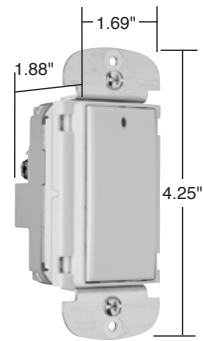

PSHSILA

Residential Dimmers & Fan Speed Controls LightSense™ Matching Wired Devices

Features

- Dimmers must be de-rated when ganged or when used with non-incandescent loads.
- Compatible with Decorator wall plates.
- 5-year warranty.

PSHDI

- No neutral required.

PSHDU

- Neutral required.

Catalog Number	Description	Voltage	Watt/Amp at 120V	Watt at 277V	Color
NEW Incandescent Dimmers					
PSHDII PSHDIW PSHDIBK PSHDILA	Multi-Location Dimmer Incandescent Only	120V	600W	—	Ivory White Black Light Almond
NEW Universal Dimmers					
PSHDUI PSHDUW PSHDUBK PSHDULA	Universal Dimmer Multi-Location Incandescent, MLV, ELV, and Advance MK 10 dimmable fluorescent ballasts	120V	600W	—	Ivory White Black Light Almond
NEW Accessory Controls					
PSHCI PSHCW PSHCBK PSHCLA	Multi-Location Accessory Control	120/277V	N/A	—	Ivory White Black Light Almond
NEW De-Hummer* Fan Speed Controls					
PSHCFI PSHCFW PSHCFBK PSHCFLA	De-Hummer Fan Speed Control	120V	1.5A	—	Ivory White Black Light Almond
NEW Single Pole Switches					
PSHS1I PSHS1W PSHS1BK PSHS1LA	Single Pole Switch	120/277	1500W 1/4HP	3000W	Ivory White Black Light Almond

* Feature specially designed capacitive circuitry to virtually eliminate fan motor "hum."

De-Rate dimmers as follows:

	Single Dimmer	MAXIMUM CAPACITY	
		Dimmer at end of multi-gang	Dimmer in middle of a multi-gang
Incandescent / Quartz Halogen	600W	500W	400W
Magnetic Low-Voltage	500W	400W	300W
Electronic Low-Voltage	500W	400W	300W
Cold Cathode / Neon	500W	400W	300W
Fluorescent:			
– 2 Wire	500W	400W	300W
– Compact Fluorescent	500W	400W	300W

For more information about LightSense™ layout and programming, consult the Specification & Design Guide (part no. BR1579) and the Wireless Installation Guide (part no. FY1623).



Residential Dimmers & Fan Speed Controls Scene Director

Pass & Seymour



For everything people do at home, there's a combination of light sources and levels that will work best. P&S Scene Director Controls let homeowners capture these combinations (or scenes) — and recall them whenever they want at the touch of a button.



P&S Scene Director Master

No tools or plate removal necessary for programming with our exclusive, patent-pending system. Set light levels with product fully installed.

Easy to install, program, and operate for sophisticated scene control dimming.

Constant memory returns lights to previously selected level after power failure. No need to reset.

Controls up to 30 dimmers per Master, providing the ability to control even complex, multiroom scenes.

Available infrared remote (SCIR) provides mobile control flexibility.

Matching Fan Speed Control available.



SCMC5WV

Buttons glow when selected — glow levels are adjustable, too.

Raises or lowers all lights in any scene simultaneously.

One-touch selection for up to five lighting environments (scenes) — plus full Off.

Programmable fade rates enable users to easily select the speed of fade-up and fade-down.

Provides powerful control via conventional wall-box wiring. Wires like a 3-way switch. Communication among devices requires just one additional conductor.

P&S Scene Director Dimmer

Works in conjunction with a P&S Scene Director Master.

Red LED glows when dimmer is OFF.

Green LEDs indicate light level selected and preset level.

Can be operated individually.

SC600LAV

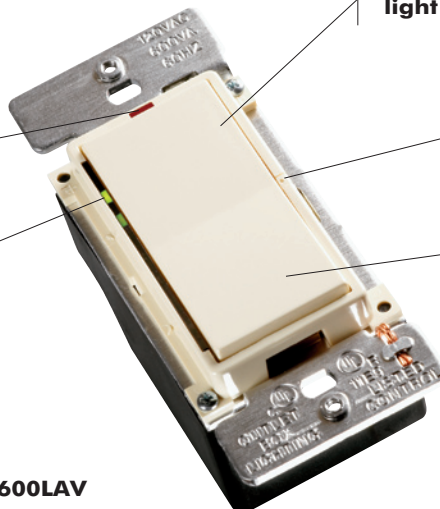

Touch pad raises or lowers individual light levels without affecting preset.

Unobtrusive set button for simple programming of preset scenes.

Sleek, ergonomic P&S Decorator style matches other Decorator devices.

Constant memory returns lights to previously selected level after power failure.



Residential Dimmers & Fan Speed Controls Scene Director



SC600LAV
SCELV300LAV
SCFB600LAV



SCMC5WV



SCRLAV

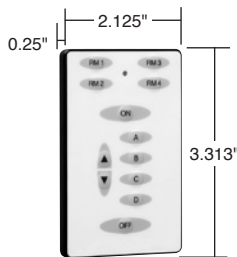

SCIR

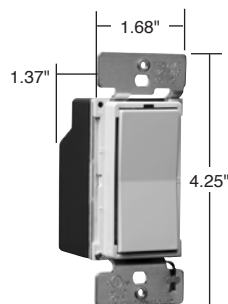

SCDH15LAV

Catalog Number	Description	Ratings	Color
600W Incandescent Scene Director Control Dimmers			
SC600IV SC600WV SC600LAV	Preset, Controls 1 Load in a Scene	120V, 600 Watt	Ivory White Light Almond
300VA Electronic Low-Voltage Scene Director Control Dimmers			
SCELV300IV SCELV300WV SCELV300LAV	Preset, Controls 1 Load in a Scene	120V, 300VA	Ivory White Light Almond
600VA Fluorescent Ballast Scene Director Control Dimmers*			
SCFB600IV SCFB600WV SCFB600LAV	Preset, Controls 1 Load in a Scene	120V, 600VA	Ivory White Light Almond
5 Scene Director Master Controllers			
SCMC5IV SCMC5WV SCMC5LAV	5-Button Preset Scene Controller	120V	Ivory White Light Almond
Remote Location Control			
SCRIV SCRWV SCRLAV	For Full Dimming or Fan Speed Control of 1 Load from Two or More Locations	120V	Ivory White Light Almond
Accessories			
SCIR SCMCK	Infrared Hand-Held Remote Preprinted Inserts for Master Controller		
1.5A De-Hummer** Fan Speed Controllers			
SCDH15IV SCDH15WV SCDH15LAV	Preset, Controls 1 Fan Load in a Scene	120V, 1.5A	Ivory White Light Almond

*Use with Advance Mark X® dimmable fluorescent ballasts.

** Feature specially designed capacitive circuitry to virtually eliminate fan motor "hum."

Note: All Dimmers on this page may be ganged without de-rating.

Wiring Diagram

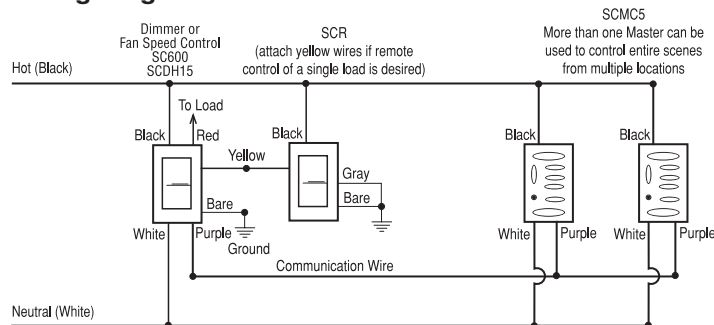

Add additional dimmers, fan speed controls, and remotes (up to 30) as needed to control more loads. Use same wiring practices as above.



Residential Dimmers & Fan Speed Controls Leandro®

Pass & Seymour



Features	
<ul style="list-style-type: none"> Enables full dimming control from up to 30 locations using the matching remote dimmers. Constant memory returns lights to previous level after power failure. LED indicators keep you informed. Green LEDs indicate preset level and current light level. Red LED night light glows when load is OFF. Easy operation — Tap up once for preset, twice for full ON. Tap down once for full OFF. Hold paddle up to raise lights, down to lower. 	<ul style="list-style-type: none"> Sleek, ergonomic P&S Decorator style matches other Decorator devices. Unobtrusive preset selection button helps prevent accidental setting changes. Elegant fade ON and OFF extends bulb life. Easy on the eyes, too. Installs easily using the same wiring as conventional 3-way switches. Change light level without affecting preset.

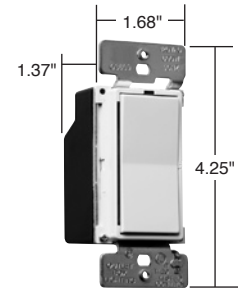

**D600MLAV
DFB600MLAV
DLV600MLAV
DRMLAV**

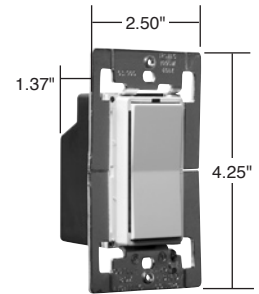

D1000MLAV

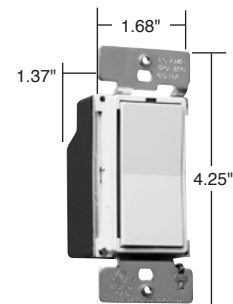

DDH15MLAV

Catalog Number	Description	Ratings	Color
600W Incandescent Preset Dimmers†			
D600MIV D600MWV D600MBKV D600MLAV	Preset, Single Pole and 3-Way	120V 600 Watt	Ivory White Black Light Almond
1000W Incandescent Preset Dimmers†			
D1000MIV D1000MWV D1000MLAV	Preset, Single Pole and 3-Way	120V 1000 Watt	Ivory White Light Almond
600VA Low-Voltage Preset Dimmers**†			
DLV600MIV DLV600MWV DLV600MLAV	Preset, Single Pole and 3-Way	120V 600VA	Ivory White Light Almond
600VA Fluorescent Ballast Preset Dimmers***††			
DFB600MIV DFB600MWV DFB600MLAV	Preset, Single Pole and 3-Way	120V 600VA	Ivory White Light Almond
Remote Dimmers†			
DRMIV DRMWV DRMBKV DRMLAV	Full Dimming or Fan Speed Control from Two or More Locations	120V	Ivory White Black Light Almond
1.5A De-Hummer†† Fan Controls			
DDH15MIV DDH15MWV DDH15MLAV	Preset, Single Pole, 3-Speed	120V 1.5A	Ivory White Light Almond

* Use with MR16s with magnetic transformers, neon, cold cathode, general inductive loads.

** Use with Advance Mark X® dimmable fluorescent ballasts.

† All dimmers and fan controls can be dimmed from more than one location when used with DRM remotes. Uses standard 3-way wiring. See wiring diagram.

†† Feature specially designed capacitive circuitry to virtually eliminate fan motor "hum."

Wiring Diagrams

Single Pole

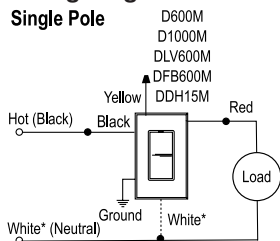

* Neutral required on DLV, DFB and DDH models. (No common neutral on dimmed circuits.)

Full Dimming & Fan Speed Control from Two or More Locations

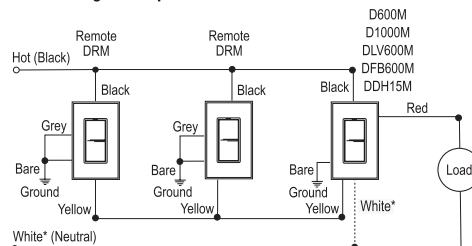

* Neutral required on DLV, DFB and DDH models. (No common neutral on dimmed circuits.)

Can be used with up to 30 dimmers, fan speed controls, and remotes.

Max. Load Rating	Fins Removed	
	One Side	Two Side
600W/VA	No De-Rating Required	
1000W	800W	600W

All devices listed on this page conform to NEMA WD-1 and WD-6. UL Listed and CSA Certified.

Pass & Seymour



Residential Dimmers & Fan Speed Controls

Harmony™ Dimmers & Fan Speed Controls

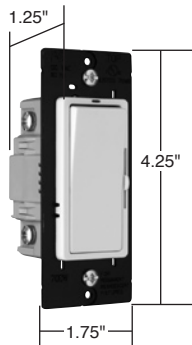

D703PW



D1103PLA

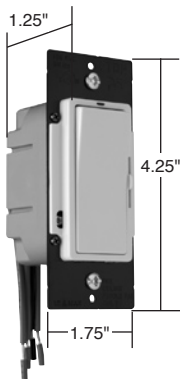

DDH16PLA

Features

- Convenient operation – combines ON/OFF Decorator switch with separate slider for dimming control.
- Green LED glows when OFF to make dimmer easy to find in the dark.
- Constant memory returns lights to previous level after a power failure.
- Sleek, ergonomic P&S Decorator style matches other Decorator devices.
- Higher ratings.
- Single pole and 3-way operation.
- Works with standard 3-way switches and wiring.
- Screw-pressure-plate backwire terminals save time, space and money.

D703P, DLV703P, DDH16P

- No de-rating.
- No fins to break.



Catalog Number	Description	Ratings	Color
Incandescent Single Pole/3-Way Dimmers*			
D703PI D703PW D703P D703PBK D703PLA	Incandescent Single Pole and 3-Way	120V, 700W	Ivory White Brown Black Light Almond
D1103PI D1103PW D1103P D1103PBK D1103PLA	Incandescent Single Pole and 3-Way	120V, 1100W	Ivory Ivory Brown Black Light Almond
Magnetic Low-Voltage Single Pole/3-Way Dimmers			
DLV703PI DLV703PW DLV703P DLV703PBK DLV703PLA	Magnetic Low Voltage Single Pole and 3-Way	120V, 700VA	Ivory White Brown Black Light Almond
DLV1103PI DLV1103PW DLV1103P DLV1103PBK DLV1103PLA	Magnetic Low Voltage Single Pole and 3-Way	120V, 1100VA	Ivory White Brown Black Light Almond
Fluorescent Single Pole/3-Way Dimmers**			
DFB8PI DFB8PW DFB8P DFB8PBK DFB8PLA	Two Wire Fluorescent Single Pole and 3-Way	120V, 8A	Ivory White Brown Black Light Almond
De-Hummer† Fan Speed Controls			
DDH16PI DDH16PW DDH16P DDH16PBK DDH16PLA	De-Hummer Fan Speed Control	120V, 1.6A	Ivory White Brown Black Light Almond



* Available in visionPak™ packaging, add "V" to Catalog Number. Example: D703PLAV.

** For use with Advance MK10 dimming ballasts. See instruction sheet for complete list of compatible ballasts.

† Feature specially designed capacitive circuitry to virtually eliminate fan motor "hum."

De-Rating Chart for Harmony Dimmers

Catalog Number	Maximum Load	Multi-Gang De-Rating		Catalog Number	Maximum Load	Multi-Gang De-Rating	
		2 Gang	3 Gang			2 Gang	3 Gang
D703P	700W	700W	700W	DLV1103P	1100VA	950VA	700VA
D1103P	1100W	1100W	800W	DFB8P	8A	8A	6.5A
DLV703P	700VA	700VA	650VA	DDH16	1.6A	1.6A	1.6A



Residential & Light Commercial Dimmers & Fan Speed Controls LS Series Dimmers

Pass & Seymour



Dimmers & Fan Speed Controls

LS Series Dimmers

Features

- Ergonomic design and solid, quality feel combine for smooth, easy operation and precise control.
- Electromagnetic and radio-frequency interference protection built in.
- Sleek, sculpted contemporary design. No dirt-catching crevices.
- Tough, impact-resistant thermoplastic housing makes it a perfect choice for new home construction. Matching, unbreakable TradeMaster® wall plate available for all models.
- Preset ON/OFF switch automatically returns controlled lights to preset level without readjusting dimmer setting.
- Exclusive, screw-pressure-plate back wire terminals save time, space and money. Designed for 12 and 14 gauge wire, stranded or solid. No-wire-lead design eliminates wire nuts.
- Superior heat management.
- No de-rating on 600W units.
- Patented Snap-In Light Module (sold separately) transforms the dimmer into an illuminated dimmer. See Page N-16 for information.

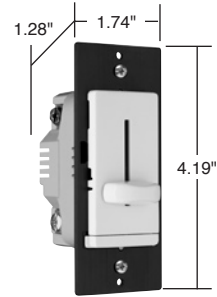

LS600LA

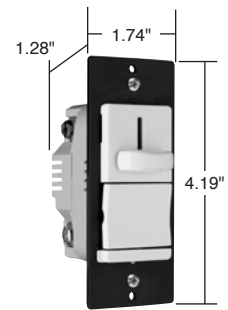

LS600PLA

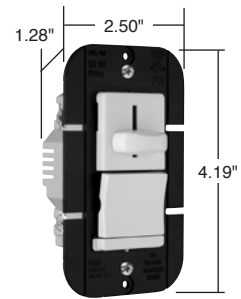

LS1000PLA

Catalog Number		Description	Ratings	Color
Single Pole	Three-Way			
600W Incandescent Slide Dimmers*				
LS600I LS600W LS600 NEW NEW LS600BK LS600LA		Non-Preset	120V, 600W max.	Ivory White Brown Black Light Almond
LS600PI LS600PW LS600P NEW NEW LS600PBK LS600PLA	LS603PI LS603PW LS603P NEW NEW LS603PBK LS603PLA	Preset	120V, 600W max.	Ivory White Brown Black Light Almond
1000W Incandescent Slide Dimmers*				
LS1000I LS1000W LS1000 NEW NEW LS1000BK LS1000LA		Non-Preset	120V, 1000W max.	Ivory White Brown Black Light Almond
LS1000PI LS1000PW LS1000P NEW NEW LS1000PBK LS1000PLA	LS1003PI LS1003PW LS1003P NEW NEW LS1003PBK LS1003PLA	Preset	120V, 1000W max.	Ivory White Brown Black Light Almond
600VA Magnetic Low-Voltage Slide Dimmers**				
LSLV600I LSLV600W LSLV600 NEW NEW LSLV600BK LSLV600LA		Non-Preset	120V, 600VA max.	Ivory White Brown Black Light Almond
LSLV600PI LSLV600PW LSLV600P NEW NEW LSLV600PBK LSLV600PLA	LSLV603PI LSLV603PW LSLV603P NEW NEW LSLV603PBK LSLV603PLA	Preset	120V, 600VA max.	Ivory White Brown Black Light Almond

* Available in VisionPak™ packaging, add "V" to Catalog Number. Example: LS600IV.

** Available in boxed packaging only.

For wiring diagrams, see Page U-24.

Max. Load Rating	Fins Removed	
	One Side	Two Side
De-Rating Chart		
LS600, LS603	No De-Rating Required	
LS1000P, LS1003P	900W	750W
LS1000	850W	700W

All devices listed on this page conform to NEMA WD-1 and WD-6. UL Listed and CSA Certified.

Pass & Seymour



Residential & Light Commercial Dimmers & Fan Speed Controls

LS Series Dimmers

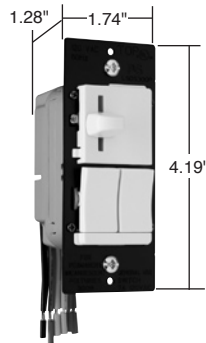

LSDS300PW

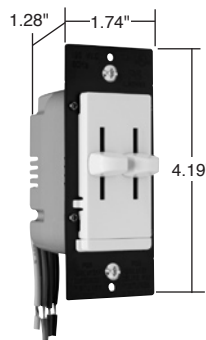

LSDD300W

Catalog Number	Description	Ratings		Color
		Dimmer	Switch	
NEW Single Pole/3-Way Preset Dimmers & Switches				
LSDS300PI LSDS300PW LSDS300P LSDS300PBK LSDS300PLA	Single Pole/3-Way Preset Dimmer and Independent Single Pole/3-Way Switch	120V 300W	7A general purpose resistive and ballast, 1/4 hp 900W tungsten	Ivory White Brown Black Light Almond
NEW Dual Slide to OFF Single Pole Dimmers				
LSDD300I LSDD300W LSDD300 LSDD300BK LSDD300LA	Dual Slide to OFF Single Pole Dimmers	120V 300W	—	Ivory White Brown Black Light Almond

Catalog Number	Maximum Load	Multi-Gang De-Rating	
		2 Gang	3 Gang
De-Rating Chart			
LSDS300	300W	300W	300W
LSDD300	300W	300W	300W

For wiring diagrams, see Page U-24.

Features

- No tool needed, module snaps-in.
- Lights when OFF.
- Uses energy-efficient 1/4 watt LED light.
- LED light will not generate heat and will last on average 47 years.



TM8LMCC

Catalog Number	Rating A. VAC	Color
Snap-In Light Module		
TM8LMCC	15 120/125	Clear

Catalog Number	Description	Color
Accessories for LS Series		
LRKIV LRKWV LRKV LRKBKV LRKLAV	Replacement Knobs for Decorator Dual Slides	Ivory White Brown Black Light Almond
LLRKIV LLRKWV LLRKV LLRKBKV LLRKLAV	Large Replacement Knobs for Decorator Single Slides	Ivory White Brown Black Light Almond

NEW
NEW

NEW
NEW



Residential & Light Commercial Dimmers & Fan Speed Controls

LS Series Fan Speed Controls

Pass & Seymour



Features	
■	Tough impact-resistant thermoplastic housing.
■	Power-failure memory.
■	Superior heat management: no time wasting break off tabs.
■	Exclusive, screw-pressure-plate back wire terminals eliminates wire nuts.
■	Can be used with patented Snap-In Light Module (sold separately).

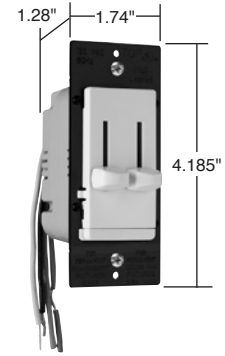

LSDC16LAV

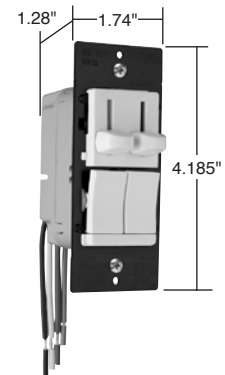

LSDC163PLAV

Catalog Number	Description	Ratings	Color
Decorator Slide Fan Speed Controls*			
NEW NEW LSSC5I LSSC5W LSSC5 LSSC5BK LSSC5LA	Non-Preset, Single Pole, Adjustable Trim	5A	Ivory White Brown Black Light Almond
NEW NEW LSSC5PI LSSC5PW LSSC5P LSSC5PBK LSSC5PLA	Preset, Single Pole, Adjustable Trim	5A	Ivory White Brown Black Light Almond
Decorator Slide De-Hummer Controls**			
NEW NEW LSDH16IV LSDH16WV LSDH16V LSDH16BKV LSDH16LAV	Non-Preset, 4-Speed Fan Control	1.6A	Ivory White Brown Black Light Almond
Dual Control Decorator Slides**			
NEW NEW LSDC16IV LSDC16WV LSDC16V LSDC16BKV LSDC16LAV	Non-Preset, 3-Speed De-Hummer Fan Control with Single Pole Dimmer	1.6A/300W	Ivory White Brown Black Light Almond
NEW NEW NEW NEW NEW LSDC163PIV LSDC163PWV LSDC163PV LSDC163PBKV LSDC163PLAV	Preset, Single Pole/3-Way 3-Speed De-Hummer Fan Control with Single Pole/3-Way Dimmer	1.6A/300W	Ivory White Brown Black Light Almond
NEW NEW LSDV25IV LSDV25WV LSDV25V LSDV25BKV LSDV25LAV	Non-Preset, Variable Speed Fan Control With Single Pole Dimmer	2.5A/300W	Ivory White Brown Black Light Almond

* Available in VisionPak™ packaging, add "V" to Catalog Number. Example: LSSC5IV.

** Available in VisionPak™ only.

Feature specially designed capacitive circuitry to virtually eliminate fan motor "hum."

For wiring diagrams, see Page U-24.

Pass & Seymour



Residential & Light Commercial Dimmers & Fan Speed Controls

Decorator Rotary DR Series

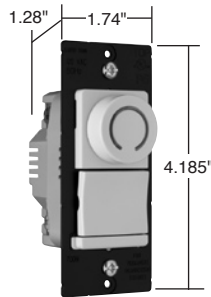

DR703PLAV

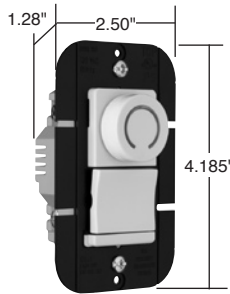

DR1103PWW



Illuminated knob indicates light level.

Features

- A new style that matches P&S Decorator Combination devices.
- Accepts Snap-In Light Module (sold separately) to convert decorator rotary devices into illuminated-type in moments; makes devices easy to find in the dark. See Page N-20.
- Screw-pressure-plate backwiring speeds installation and ensures solid, high-quality electrical connections. Also supports traditional, wire-loop side wiring.
- Heavy-gauge black anodized aluminum strap provides superior heat management and structural strength for mounting against wall surfaces.
- Slim design leaves more room in the box and makes installation faster and easier.
- Higher ratings of 700 and 1100 watts.
- No de-rating of 700 watt devices.
- Single pole and 3-way in same device.

Catalog Number	Description	Ratings	Color
NEW Incandescent Preset Dimmers			
DR703PIV DR703PWW DR703PV DR703PBKV DR703PLAV	Single Pole/3-Way Dimmer with Pilot Light	120V, 700W	Ivory White Brown Black Light Almond
DR1103PIV DR1103PWW DR1103PV DR1103PBKV DR1103PLAV	Single Pole/3-Way Dimmer with Pilot Light	120V, 1100W	Ivory White Brown Black Light Almond
NEW Magnetic Low-Voltage Dimmers			
DRLV703PIV DRLV703PWW DRLV703PV DRLV703PBKV DRLV703PLAV	Single Pole/3-Way Dimmer with Pilot Light	120V, 700VA	Ivory White Brown Black Light Almond
DRLV1103PIV DRLV1103PWW DRLV1103PV DRLV1103PBKV DRLV1103PLAV	Single Pole/3-Way Dimmer with Pilot Light	120V, 1100VA	Ivory White Brown Black Light Almond
NEW Continuously Variable Preset Fan Speed Controls			
DRSC53PIV DRSC53PWW DRSC53PV DRSC53PBKV DRSC53PLAV	Single Pole/3-Way Fan Speed Control	120V, 5A	Ivory White Brown Black Light Almond
NEW 3-Speed De-Hummer* Preset Fan Speed Controls			
DRDH163PIV DRDH163PWW DRDH163PV DRDH163PBKV DRDH163PLAV	Single Pole/3-Way Fan Speed Control with back-lit speed indication	120V, 1.6A	Ivory White Brown Black Light Almond

Available in VisionPak™ only.

* Feature specially designed capacitive circuitry to virtually eliminate fan motor "hum."

De-Rating Chart for DR Series

Catalog Number	Maximum Load	Multi-Gang De-Rating	
		2 Gang	3 Gang
DR703	No De-Rating Required		
DR1103	1100W	900W	750W



Residential & Light Commercial Dimmers & Fan Speed Controls Wide Slide Series

Pass & Seymour



Full-On Bypass

When the dimmer is placed in the full-On position, the dimming circuitry is bypassed by latching contacts. This feature allows for 100% lighting output and extends dimmer life by eliminating heat build-up.

Features	
<ul style="list-style-type: none"> Maximum ratings are for continuous full load. Many 1000W models fit standard Decorator plates. RFI suppression built in. Full-On bypass. 	<ul style="list-style-type: none"> Preset "ON/OFF" switch automatically returns controlled lights to preset level without readjusting dimmer setting. 600W maximum rated dimmers can be ganged without de-rating.

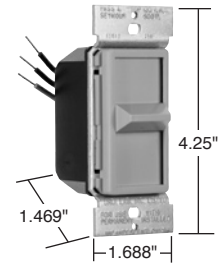

P 90680 P 90683
N 90681

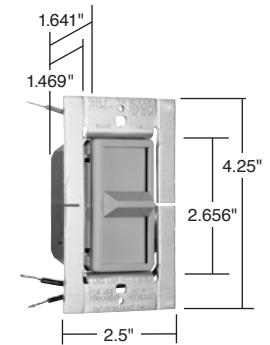

P 91180 P 91183
N 91181

P = Preset
N = Non-Preset

Catalog Number		Description	Ratings	Color
Single Pole	Three-Way			
600W Incandescent Specification Grade Slide Dimmers				
90680I* 90680W* 90680GRY 90680LA*	90683I* 90683W* 90683GRY 90683LA*	Preset	120V 600W max.	Ivory White Gray Light Almond
90681I* 90681W* 90681GRY 90681LA*		Non-Preset	120V 600W max.	Ivory White Gray Light Almond
1000W Incandescent Specification Grade Slide Dimmers				
91180I 91180W 91180GRY 91180LA	91183I 91183W 91183GRY 91183LA	Preset	120V 1000W max.	Ivory White Gray Light Almond
91181I 91181W 91181LA		Non-Preset	120V 1000W max.	Ivory White Light Almond

* Available in VisionPak™ packaging, add "V" to Catalog Number. Example: 90680IV.

Max. Load Rating	Fins Removed	
	One Side	Two Side
De-Rating Chart		
1000W	800W	700W

Note: Each side removed reduces plate size by 3/8".

Slide Dimmer 3-Way Wiring Diagram

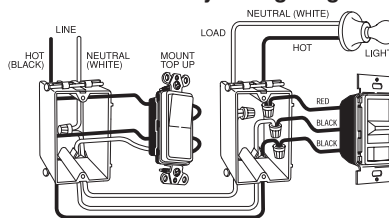

Pass & Seymour



Residential & Light Commercial Dimmers & Fan Speed Controls

Wide Slide Series

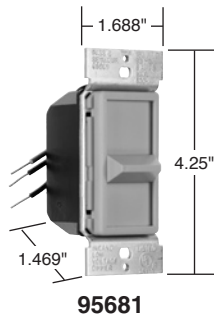

Full-ON Bypass

When the dimmer or control is placed in the full-ON position, the dimming or speed control circuitry is bypassed by latching contacts. This feature allows for 100% motor output and extends dimmer or speed control's life by eliminating heat build-up.

Field Adjustable Trim

This feature allows the user to set the minimum speed level desired and helps prevent damage to motor due to stalling. Models without field adjustable trims feature factory settings for minimum anti-stall levels.

Features

- Maximum rating for full continuous load.
- Full-ON bypass.
- 600VA dimmers may be ganged without de-rating.
- Compatible with Decorator wall plates.
- RFI suppression built-in.

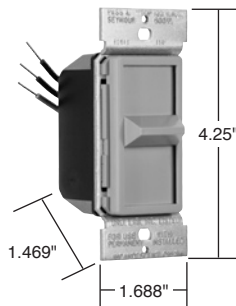

Catalog Number	Description	Ratings	Color
Magnetic Low-Voltage* Specification Grade Slide Dimmers			
95681I 95681W 95681LA	Non-Preset/Full-ON Bypass, MLV	120V 600VA max.	Ivory White Light Almond

* For use with magnetic transformer supplied incandescent low-voltage lighting.

Max. Load Rating	Fins Removed	
	One Side	Two Side
De-Rating Chart		
1000VA	800VA	700VA

Features

- Full range speed control.
- Compatible with Decorator wall plates.
- 100% tested for symmetry for extended fan life.
- Ground lead provided.
- Ferrite bar coil choke for excellent RFI suppression.

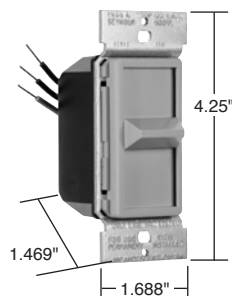

Catalog Number	Description	Ratings	Color
5A Max. Slide Fan Speed Controls			
94580I 94580W	Preset, Full-ON Bypass, Adjustable Trim May Be Ganged Without De-Rating	120V 5A max.	Ivory White
94581I* 94581W* 94581LAV**	Non-Preset, Full-ON Bypass, Adjustable Trim, May Be Ganged Without De-Rating	120V 5A max.	Ivory White Light Almond

* Available in VisionPak™ packaging, add "V" to Catalog Number. Example: 94581IV.

**Available in VisionPak™ only.

No-Noise De-Hummers

Since the development of variable fan speed controls, many fans have made an annoying humming noise when their speed was reduced. Through the use of specially designed capacitive circuitry, these units can control fans at 3 or 4-speed levels in slide, rotary, and dual styles with virtually no fan motor noise.

Catalog Number	Description	Ratings	Color
1.5A Max. No-Noise De-Hummer Specification Grade Fan Speed Controls – RFI Protected			
94084I* 94084W* 94084GRY 94084LA*	3-Speed, Single Pole	120V 1.5A max.	Ivory White Gray Light Almond

* Available in VisionPak™ packaging, add "V" to Catalog Number. Example: 94084LAV.

All devices listed on this page conform to NEMA WD-1 and WD-6. UL Listed and CSA Certified.

Residential Dimmers & Fan Speed Controls TradeMaster® Short Slide

Pass & Seymour



Dimmers & Fan Speed Controls

Features	
<ul style="list-style-type: none"> Contemporary slide style for toggle opening. Tough impact-resistant thermoplastic housing. Power-failure memory. Superior heat management: no time wasting break off tabs. Exclusive, screw-pressure-plate back wire terminals eliminates wire nuts. 	

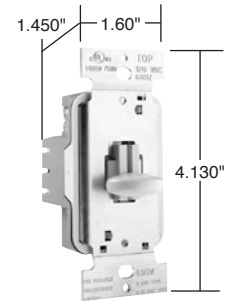

SS600W
SSSC5W

Catalog Number		Description	Ratings	Color
Single Pole	Three-Way			
600W Incandescent Short Slide Dimmers*				
SS600I SS600W SS600LA	SS603I SS603W SS603LA	Non-Preset	120V 600W max.	Ivory White Light Almond
600W Incandescent – Lighted Short Slide Dimmers**				
SS600LI SS600LW SS600LLA	SS603LI SS603LW SS603LLA	Non-Preset	120V 600W max.	Ivory White Light Almond
1000W Incandescent Short Slide Dimmers**				
SS1000I SS1000W SS1000LA	SS1003I SS1003W SS1003LA	Non-Preset	120V 1000W max.	Ivory White Light Almond
1000W Incandescent – Lighted Short Slide Dimmers**				
SS1000LI SS1000LW SS1000LLA	SS1003LI SS1003LW SS1003LLA	Non-Preset	120V 1000W max.	Ivory White Light Almond
600VA Low-Voltage Magnetic Short Slide Dimmers**				
SSLV600I SSLV600W SSLV600LA	SSLV603I SSLV603W SSLV603LA	Non-Preset	120V 600VA max.	Ivory White Light Almond
1000VA Low-Voltage Magnetic Short Slide Dimmers**				
SSLV1000I SSLV1000W SSLV1000LA	SSLV1003I SSLV1003W SSLV1003LA	Non-Preset	120V 1000VA max.	Ivory White Light Almond
Short Slide Fan Speed Controls*				
SSSC5I SSSC5W SSSC5LA	—	Non-Preset, Adjustable Trim	120V 5A	Ivory White Light Almond

* Available in VisionPak™ packaging, add "V" to Catalog Number. Example: SS600LAV.

** Available in boxed packaging only.

Catalog Number	Description	Color
Accessories		
SRKIV SRKWV SRKLAV	Replacement Knobs for Short Slides	Ivory White Light Almond

Max. Load Rating	Gang Reduction	
	2 Dimmers	3+ Dimmers
De-Rating Chart		
600W	500W	400W
1000W	700W	650W

All devices listed on this page conform to NEMA WD-1 and WD-6. UL Listed and CSA Certified.

TradeMaster® Short Slide

More versatile than standard toggle dimmers. Provides easy ON/OFF. Separate preset and electronic touch pads allow convenient dimming control.

Matches appearance of standard P&S toggle switch.

Uses conventional 3-way wiring when used in conjunction with a 3-way switch.



Green LED night light glows when OFF.

Double click the switch to full ON raises lights to full ON automatically without losing your favorite preset.

Soft start control brings lights up slowly, extends bulb life.

T600ELA

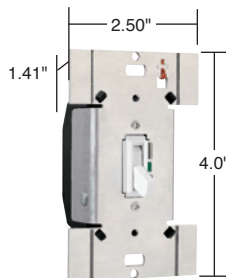

T600ELA
T1000ELA

Catalog Number	Description	Ratings	Color
600W Incandescent Toggle Dimmers*			
T600EI T600EW T600ELA	Preset, Single Pole and 3-Way	120V 600 Watt	Ivory White Light Almond
1000W Incandescent Toggle Dimmers*			
T1000EI T1000EW T1000ELA	Preset, Single Pole and 3-Way	120V 1000 Watt	Ivory White Light Almond

* Available in VisionPak™ packaging, add "V" to Catalog Number. Example: T600ELAV.
Not for use with metal wall plates.

Max. Load Rating	Fins Removed	
	One Side	Two Side
De-Rating Chart		
600W	500W	400W
1000W	800W	600W

Wiring Diagrams

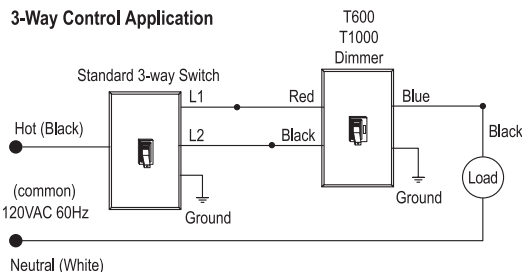
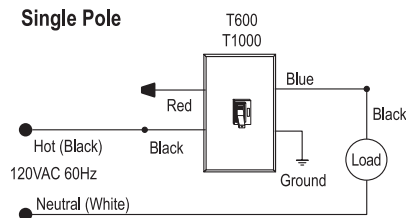



Residential Dimmers & Fan Speed Controls TradeMaster® Toggles

Pass & Seymour



Features	
<ul style="list-style-type: none"> ■ Tough impact-resistant thermoplastic housing. ■ Power-failure memory. ■ Superior heat management: no time wasting break off tabs. ■ Exclusive, screw-pressure-plate back wire terminals eliminates wire nuts. 	

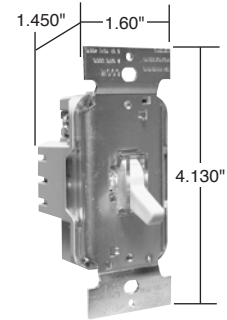

**T600I
TSC5I**

Catalog Number		Description	Ratings	Color
Single Pole	Three-Way			
600W Incandescent Toggle Dimmers				
T600I* T600W* T600* T600LA*	T603I** T603W** T603** T603LA**	Non-Preset	120V 600W	Ivory White Brown Light Almond
600W Incandescent – Lighted Toggle Dimmers*				
T600LI T600LW T600LLA	T603LI T603LW T603LLA	Non-Preset	120V 600W	Ivory White Light Almond
1000W Incandescent Toggle Dimmers				
T1000I* T1000W* T1000* T1000LA*	T1003I** T1003W** T1003** T1003LA**	Non-Preset	120V 1000W	Ivory White Brown Light Almond
1000W Incandescent – Lighted Toggle Dimmers**				
T1000LI T1000LW T1000LLA	T1003LI T1003LW T1003LLA	Non-Preset	120V 1000W	Ivory White Light Almond
600VA Low-Voltage Magnetic Toggle Dimmers*				
TLV600I TLV600W TLV600LA	TLV603I TLV603W TLV603LA	Non-Preset	120V 600VA	Ivory White Light Almond
1000VA Low-Voltage Magnetic Toggle Dimmers**				
TLV1000I TLV1000W TLV1000LA	TLV1003I TLV1003W TLV1003LA	Non-Preset	120V 1000VA	Ivory White Light Almond
Toggle Fan Speed Controls*				
TSC5I TSC5W TSC5LA	—	Non-Preset, Adjustable Trim	120V 5A	Ivory White Light Almond

* Available in VisionPak™ packaging, add "V" to Catalog Number. Example: T600LAV.

**Available in boxed packaging only.

Max. Load Rating	Gang Reduction	
	2 Dimmers	3+ Dimmers
De-Rating Chart		
600W	500W	400W
1000W	700W	650W

Max. Load Rating	Gang Reduction	
	2 Controls	3+ Controls
De-Rating Chart		
5A	4A	3A

Pass & Seymour



Residential Dimmers & Fan Speed Controls Rotary R Series

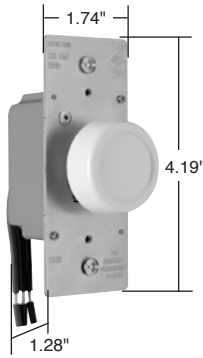

R600PWV

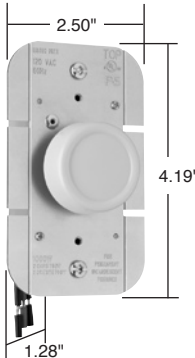

R1000WV

Features

- Slimmer design – the trimmest rotary dimmers, 1/4" less depth than the leading competitor's models.
- Easy-to-grip knob with soft, contemporary curves goes with any décor. Interchangeable with older-style knobs.
- Excellent RFI/EMI filtering performance – won't impact sensitive electronic devices.
- Pre-stripped leads speed termination.
- No de-rating of 600 watt models in multi-gang applications.
- Leaves more room in the box for faster, easier installation.
- Makes small adjustments in lighting levels easier.
- Illuminated models are easy to find in the dark.

Catalog Number		Description	Ratings	Color
Single Pole	Three-Way			
NEW 600W Incandescent RFI Rotary Dimmers				
R600IV R600WV R600LAV		Non-Preset	120V 600W	Ivory White Light Almond
R600PIV R600PWV R600PLAV	R603PIV R603PWV R603PLAV	Preset	120V 600W	Ivory White Light Almond
NEW 600W Incandescent Lighted RFI Rotary Dimmers				
R600PLIV R600PLWV R600PLLAV	R603PLIV R603PLWV R603PLLAV	Preset Lighted	120V 600W	Ivory White Light Almond
NEW 1000W Incandescent RFI Rotary Dimmers				
R1000IV R1000WV R1000LAV		Non-Preset	120V 1000W	Ivory White Light Almond
R1000PIV R1000PWV R1000PLAV	R1003PIV R1003PWV R1003PLAV	Preset	120V 1000W	Ivory White Light Almond

Available in VisionPak™ only.

Catalog Number	Description	Color
NEW Rotary Replacement Knobs		
RRKIV RRKWV RRKLAV	Plain Replacement Knob	Ivory White Light Almond
RRKCLGV RRKIGV RRKWGV RRKLAGV	Deluxe Replacement Knob	Clear Ivory White Light Almond

De-Rating Chart for R Series

Catalog Number	Maximum Load	Multi-Gang De-Rating	
		2 Gang	3 Gang
R600, R600P	600W	No De-Rating Required	
R1000	1000W	750W	700W
R1000P	1000W	900W	800W
R1003P	1000W	900W	800W



Residential Dimmers & Fan Speed Controls Rotary Series

Pass & Seymour



Features	
<ul style="list-style-type: none"> Full range rotary dimming. Low-voltage and fluorescent models have field adjustable trims that may be set to control minimum light level. Ground lead provided on all models. Voltage compensation circuitry in fluorescent and magnetic low-voltage model reduces lighting fluctuations. 	<ul style="list-style-type: none"> All models fit standard toggle wall plate. All dimmers on this page may be ganged without de-rating. RFI protected.

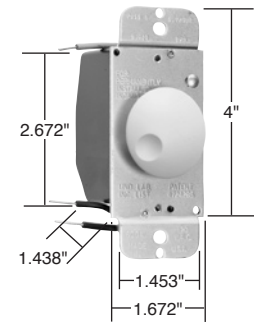

90621

Catalog Number	Description	Ratings	Color
600W Max. Incandescent Specification Grade Rotary Dimmers			
90621IV	Single Pole	120V	Ivory
90621WV	Low Profile, Dial On/Off	600W max.	White

Available in VisionPak™ only.

Catalog Number	Description	Color
Accessories for 90621		
823178I	Replacement Knob	Ivory
82317832	Replacement Knob	White

Catalog Number	Description	Ratings	Color
Magnetic Low-Voltage Specification Grade Rotary Dimmers Single Pole			
95600I	Preset, Push On/Off	120V	Ivory
95600W		600VA max.	White

For use with magnetic transformer incandescent low-voltage lighting.

Features	
<ul style="list-style-type: none"> Easily gangable by removing scored heat sink fins. Voltage compensation circuitry reduces lighting fluctuations. RFI suppression built-in. 	<ul style="list-style-type: none"> Knob and cover replacements available to change colors. Fits in standard toggle wall plate opening.

Catalog Number	Description	Ratings	Color
1000W Max. Incandescent Heavy Use Rotary Dimmers			
91101I	Single Pole, Dial, On/Off	120V	Ivory
91101W		1000W max.	White

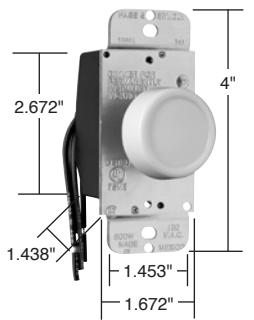

95600

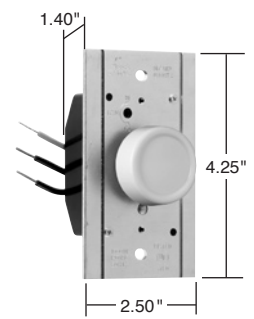

91101

Rotary Dimmer 3-Way Wiring Diagram

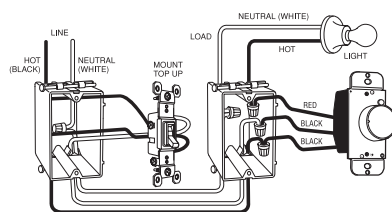

Max. Load Rating	Fins Removed	
	One Side	Two Side
De-Rating Chart		
600W	500W	400W
600VA	450VA	400VA
1000VA	800VA	700VA
1000W	800W	700W
1500W	1400W	1300W
2000W	1800W	1600W

All devices listed on this page conform to NEMA WD-1 and WD-6. UL Listed and CSA Certified.

Pass & Seymour

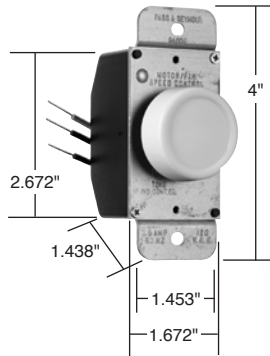

94004
94003

Residential Dimmers & Fan Speed Controls

Rotary Fan Speed Controls

No-Noise De-Hummers

Since the development of variable fan speed controls, many fans have made an annoying humming noise when their speed was reduced. Through the use of specially designed capacitive circuitry, these units can control fans at 3 or 4-speed levels in slide, rotary and dual styles with virtually no fan motor noise.

Catalog Number	Description	Ratings	Color
1.5A Max. Specification Grade Rotary Fan Speed Controls – No-Noise De-Hummers, RFI Protected*			
94003I 94003W 94003LA	3-Speed, Low-Medium-High	120V 1.5A max.	Ivory White Light Almond
94004CL 94004I 94004W 94004LA	4-Speed, Low-High	120V 1.5A max.	Clear Ivory White Light Almond

* Available in VisionPak™ packaging, add "V" to Catalog Number. Example: 94003LAV.

Dual Control Features

- Fits one gang box.
- Controls both fan speed and light level.
- Decorator styling.

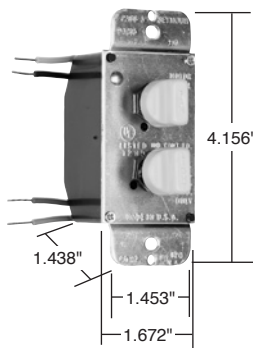

94215
94315
94331
542433

Catalog Number	Description	Ratings	Color
1.5A/300W Max. Specification Grade Dual Controls – No-Noise De-Hummers*			
94315I 94315W 94315LA	3-Speed Fan Control and 2-Level Hi/Low Dimmer	120V 1.5A/300W max.	Ivory White Light Almond
94215I 94215W 94215LA	4-Speed Fan Control and 2-Level Hi/Low Dimmer	120V 1.5A/300W max.	Ivory White Light Almond

Requires 3 wire installation.

* Available in VisionPak™ packaging, add "V" to Catalog Number. Example: 94315LAV.

Catalog Number	Description	Ratings	Color
3A/300W Max. Specification Grade Dual Controls*			
94331I 542433	Dial Speed Control and Dimmer	120V 3A/300W max.	Ivory White

* Available in VisionPak™ packaging, add "V" to Catalog Number. Example: 94331IV.

Catalog Number	Description	Color
Accessories for Dual Controls		
109019V 109020V 109018V	Adapter Kit for Dual Fan/Light Controls	Ivory White Light Almond

Note: All controls on this page may be ganged without de-rating.

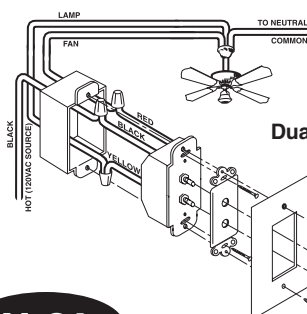

Dual Control Connection Diagram



Commercial Dimmers & Fan Speed Controls Titan™ Series

Pass & Seymour



A complete solution for easy, economical multi-gang installations.

The P&S Titan™ Series have key features designed to increase installer productivity. Each comes with all the screwless wall plate components necessary for single gang or multi-gang installations. No need to order any additional components such as long-lead time custom wall plates to finish the job. Complete the installation with everything right out of the box, increasing productivity by finishing up in one visit instead of several.

Included screwless wall plate components make it easy to assemble a custom multi-gang wall plate in any configuration — saving money and time.

Power-failure memory retains presets through power outages.

Widest choice of amperage ratings with minimal or no de-rating for faster job planning.

Preset models feature large ON/OFF button and single pole/three-way functionality.

High-reliability design with built-in surge and static protection plus oversize output devices to stand up to abuse.

Exclusive labeling system has a built-in label holder enabling instant circuit identification; looks clean and professional.

Included end-caps and spacers screw directly to heat sinks; center plate snaps easily on and off.



CD703PW

Enclosed slider helps prevent dust and dirt contamination.

Exclusive adjustable limit control in incandescent dimmers saves energy and extends bulb life — reduces maximum output by up to 10 percent.

Air-gap switch

Improved heat management enables superior load ratings.



CDADAPTORKITW



Adaptor kit enables matching installation of standard P&S Decorator Devices — outlets, switches, GFCIs and more.



**CD703PW
Narrow**



**CD1100W
Narrow**

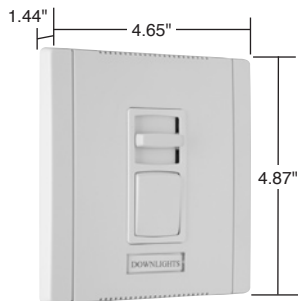

**CD1603PW
Wide**

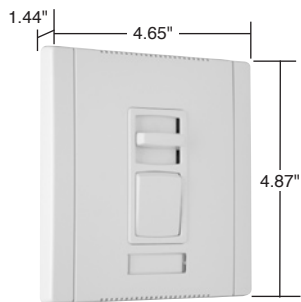

**CD2003PW
Wide**

Features

- Field configurable wall plate system.
- Labeling system.
- Adjustable top end output voltage.
- Shipped with protective film.
- Rugged construction.
- Superior ratings with a minimum of de-rating when ganged.
- Simple to plan the rough-in.
- Available in single pole slide-to-OFF and single pole/3-way preset models.
- Attractive European styling.
- Eye-catching packaging.
- Exclusive adaptor kit to install other Decorator opening devices under the Titan™ wall plate system. (See Page N-29.)
- Blank center plate included.



Catalog Number	Description	Ratings	Narrow or Wide	Color
Incandescent				
CD700I CD700W CD700 CD700GRY CD700BK CD700LA	Single Pole, Slide-to-OFF	120V, 700W	Narrow	Ivory White Brown Gray Black Light Almond
CD703PI CD703PW CD703P CD703PGRY CD703PBK CD703PLA	Single Pole/3-Way, Preset	120V, 700W	Narrow	Ivory White Brown Gray Black Light Almond
CD1100I CD1100W CD1100 CD1100GRY CD1100BK CD1100LA	Single Pole, Slide-to-OFF	120V, 1100W	Narrow	Ivory White Brown Gray Black Light Almond
CD1103PI CD1103PW CD1103P CD1103PGRY CD1103PBK CD1103PLA	Single Pole/3-Way, Preset	120V, 1100W	Narrow	Ivory White Brown Gray Black Light Almond
CD1600I CD1600W CD1600 CD1600GRY CD1600BK CD1600LA	Single Pole, Slide-to-OFF	120V, 1600W	Wide	Ivory White Brown Gray Black Light Almond
CD1603PI CD1603PW CD1603P CD1603PGRY CD1603PBK CD1603PLA	Single Pole/3-Way, Preset	120V, 1600W	Wide	Ivory White Brown Gray Black Light Almond
CD2000I CD2000W CD2000 CD2000GRY CD2000BK CD2000LA	Single Pole, Slide-to-OFF	120V, 2000W	Wide	Ivory White Brown Gray Black Light Almond
CD2003PI CD2003PW CD2003P CD2003PGRY CD2003PBK CD2003PLA	Single Pole/3-Way, Preset	120V, 2000W	Wide	Ivory White Brown Gray Black Light Almond

For technical specifications, de-rating, and rough-in box charts, see Pages U-134 and U-135.

All devices listed on this page conform to NEMA WD-1 and WD-6. cULus Listed.



Commercial Dimmers & Fan Speed Controls Titan™ Series Magnetic Low-Voltage Dimmers & Adaptor Kit

Pass & Seymour



Features

- Field configurable wall plate system.
- Labeling system.
- Adjustable low end output voltage.
- Shipped with protective film.
- Rugged construction.
- Superior ratings with a minimum of de-rating when ganged.
- Simple to plan the rough-in.
- Available in single pole slide-to-OFF and single pole/3-way preset models.
- Attractive European styling.
- Eye-catching packaging.
- Exclusive adaptor kit to install other Decorator opening devices under the Titan™ wall plate system.
- Blank center plate included.

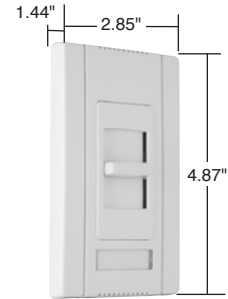

**CDLV700W
Narrow**

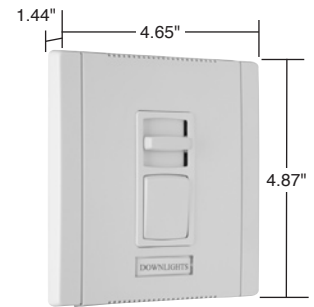

**CDLV1103PW
Wide**



CDADAPTORKITW

Adaptor kit enables matching installation of standard P&S Decorator Devices – outlets, switches, GFCIs and more. See Page N-27.

Catalog Number	Description	Ratings	Narrow or Wide	Color
Magnetic Low-Voltage				
NEW CDLV700I CDLV700W CDLV700 CDLV700GRY CDLV700BK CDLV700LA	Single Pole, Slide-to-OFF	120V, 700W	Narrow	Ivory White Brown Gray Black Light Almond
CDLV703PI CDLV703PW CDLV703P CDLV703PGRY CDLV703PBK CDLV703PLA	Single Pole/3-Way, Preset	120V, 700W	Narrow	Ivory White Brown Gray Black Light Almond
CDLV1100I CDLV1100W CDLV1100 CDLV1100GRY CDLV1100BK CDLV1100LA	Single Pole, Slide-to-OFF	120V, 1100W	Narrow	Ivory White Brown Gray Black Light Almond
CDLV1103PI CDLV1103PW CDLV1103P CDLV1103PGRY CDLV1103PBK CDLV1103PLA	Single Pole/3-Way, Preset	120V, 1100W	Narrow	Ivory White Brown Gray Black Light Almond
CDLV1600I CDLV1600W CDLV1600 CDLV1600GRY CDLV1600BK CDLV1600LA	Single Pole, Slide-to-OFF	120V, 1600W	Wide	Ivory White Brown Gray Black Light Almond
CDLV1603PI CDLV1603PW CDLV1603P CDLV1603PGRY CDLV1603PBK CDLV1603PLA	Single Pole/3-Way, Preset	120V, 1600W	Wide	Ivory White Brown Gray Black Light Almond
Adaptor Kit				
NEW CDADAPTORKITI CDADAPTORKITW CDADAPTORKIT CDADAPTORKITGRY CDADAPTORKITBK CDADAPTORKITLA	Decorator Device Adaptor Kit		Narrow	Ivory White Brown Gray Black Light Almond

For technical specifications, de-rating, and rough-in box charts, see Pages U-134 and U-135.

All devices listed on this page conform to NEMA WD-1 and WD-6. cULus Listed.

Pass & Seymour



Commercial Dimmers & Fan Speed Controls

Titan™ Series Fluorescent 2 Wire Dimmers



CDFB5W
Narrow

Features

- For use with 2 wire 120V and 277V fluorescent dimming ballasts.
- Field configurable wall plate system.
- Labeling system.
- Adjustable low end output voltage.
- Shipped with protective film.
- Rugged construction.
- Superior ratings with a minimum of de rating when ganged.
- Simple to plan the rough-in.
- Available in single pole slide-to-OFF and single pole/3-way preset models.
- Attractive European styling.
- Eye-catching packaging.
- Exclusive adaptor kit to install other Decorator opening devices under the Titan™ wall plate system. (See Page N-29.)
- Blank center plate included.

Catalog Number	Description	Ratings	Narrow or Wide	Color
NEW Fluorescent				
CDFB5I CDFB5W CDFB5 CDFB5GRY CDFB5BK CDFB5LA	2 Wire, Electronic, Single Pole, Slide-to-OFF	5A, 120V	Narrow	Ivory White Brown Gray Black Light Almond
CDFB8I CDFB8W CDFB8 CDFB8GRY CDFB8BK CDFB8LA	2 Wire, Electronic, Single Pole, Slide-to-OFF	8A, 120V	Narrow	Ivory White Brown Gray Black Light Almond
CDFB10I CDFB10W CDFB10 CDFB10GRY CDFB10BK CDFB10LA	2 Wire, Electronic, Single Pole, Slide-to-OFF	10A, 120V	Wide	Ivory White Brown Gray Black Light Almond
CDFB16I CDFB16W CDFB16 CDFB16GRY CDFB16BK CDFB16LA	2 Wire, Electronic, Single Pole, Slide-to-OFF	16A, 120V	Wide	Ivory White Brown Gray Black Light Almond
CDFB7277I CDFB7277W CDFB7277 CDFB7277GRY CDFB7277BK CDFB7277LA	2 Wire, Electronic, Single Pole, Slide-to-OFF	7A, 277V	Wide	Ivory White Brown Gray Black Light Almond
CDFB10277I CDFB10277W CDFB10277 CDFB10277GRY CDFB10277BK CDFB10277LA	2 Wire, Electronic, Single Pole, Slide-to-OFF	10A, 277V	Wide	Ivory White Brown Gray Black Light Almond

For technical specifications, de-rating, rough-in box charts, and complete list of compatible ballasts, see Pages U-136 and U-137.



Commercial Dimmers & Fan Speed Controls Titan™ Series Fluorescent 2 Wire Dimmers

Pass & Seymour



Features

- For use with 2 wire 120V and 277V fluorescent dimming ballasts.
- Field configurable wall plate system.
- Labeling system.
- Adjustable low end output voltage.
- Shipped with protective film.
- Rugged construction.
- Superior ratings with a minimum of de-rating when ganged.
- Simple to plan the rough-in.
- Available in single pole slide-to-OFF and single pole/3-way preset models.
- Attractive European styling.
- Eye-catching packaging.
- Exclusive adaptor kit to install other Decorator opening devices under the Titan™ wall plate system. (See Page N-29.)
- Blank center plate included.



**CDFB53PW
Narrow**

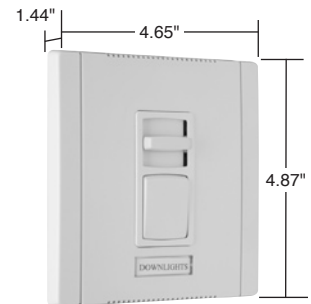

**CDFB103PW
Wide**



Catalog Number	Description	Ratings	Narrow or Wide	Color
Fluorescent				
CDFB53PI CDFB53PW CDFB53P CDFB53PGRY CDFB53PBK CDFB53PLA	2 Wire, Electronic, Single Pole/3-Way, Preset	5A, 120V	Narrow	Ivory White Brown Gray Black Light Almond
CDFB83PI CDFB83PW CDFB83P CDFB83PGRY CDFB83PBK CDFB83PLA	2 Wire, Electronic, Single Pole/3-Way, Preset	8A, 120V	Narrow	Ivory White Brown Gray Black Light Almond
CDFB103PI CDFB103PW CDFB103P CDFB103PGRY CDFB103PBK CDFB103PLA	2 Wire, Electronic, Single Pole/3-Way, Preset	10A, 120V	Wide	Ivory White Brown Gray Black Light Almond
CDFB163PI CDFB163PW CDFB163P CDFB163PGRY CDFB163PBK CDFB163PLA	2 Wire, Electronic, Single Pole/3-Way, Preset	16A, 120V	Wide	Ivory White Brown Gray Black Light Almond
CDFB73P277I CDFB73P277W CDFB73P277 CDFB73P277GRY CDFB73P277BK CDFB73P277LA	2 Wire, Electronic, Single Pole/3-Way, Preset	7A, 277V	Wide	Ivory White Brown Gray Black Light Almond
CDFB103P277PI CDFB103P277PW CDFB103P277P CDFB103P277PGRY CDFB103P277PBK CDFB103P277PLA	2 Wire, Electronic, Single Pole/3-Way, Preset	10A, 277V	Wide	Ivory White Brown Gray Black Light Almond

For technical specifications, de-rating, rough-in box charts, and complete list of compatible ballasts, see Pages U-136 and U-137.

Pass & Seymour



Commercial Dimmers & Fan Speed Controls Titan™ Series Fluorescent 3 Wire Dimmers



CD3FB163PW
Narrow

Features

- For use with 3 wire 120V and 277V fluorescent dimming ballasts.
- Field configurable wall plate system.
- Labeling system.
- Adjustable low end output voltage.
- Shipped with protective film.
- Rugged construction.
- Superior ratings with a minimum of de-rating when ganged.
- Simple to plan the rough-in.
- Available in single pole slide-to-OFF and single pole/3-way preset models.
- Attractive European styling.
- Eye-catching packaging.
- Exclusive adaptor kit to install other Decorator opening devices under the Titan™ wall plate system. (See Page N-29.)
- Blank center plate included.

Catalog Number	Description	Ratings	Narrow or Wide	Color
NEW Fluorescent				
CD3FB161 CD3FB16W CD3FB16 CD3FB16GRY CD3FB16BK CD3FB16LA	3 Wire Electronic, Single Pole, Slide-to-OFF	120V, 16A	Narrow	Ivory White Brown Gray Black Light Almond
CD3FB163PI CD3FB163PW CD3FB163P CD3FB163PGRY CD3FB163PBK CD3FB163PLA	3 Wire Electronic, Single Pole/3-Way, Preset	120V, 16A	Narrow	Ivory White Brown Gray Black Light Almond
CD3FB10277I CD3FB10277W CD3FB10277 CD3FB10277GRY CD3FB10277BK CD3FB10277LA	3 Wire Electronic, Single Pole, Slide-to-OFF	277V, 10A	Narrow	Ivory White Brown Gray Black Light Almond
CD3FB103P277I CD3FB103P277W CD3FB103P277 CD3FB103P277GRY CD3FB103P277BK CD3FB103P277LA	3 Wire Electronic, Single Pole/3-Way, Preset	277V, 10A	Narrow	Ivory White Brown Gray Black Light Almond

Available Winter 2008.



Commercial Dimmers & Fan Speed Controls Titan™ Series Fluorescent 4 Wire Dimmers

Pass & Seymour



Features	
<ul style="list-style-type: none"> For use with 0-10V, 4 wire, 120V and 277V fluorescent dimming ballasts. Field configurable wall plate system. Labeling system. Adjustable low end output voltage. Shipped with protective film. Rugged construction. Superior ratings with a minimum of de-rating when ganged. Must be used with power pack. 	<ul style="list-style-type: none"> Simple to plan the rough-in. Available in single pole slide-to-OFF and single pole/3-way preset models. Attractive European styling. Eye-catching packaging. Exclusive adaptor kit to install other Decorator opening devices under the Titan™ wall plate system. (See Page N-29.) Blank center plate included.

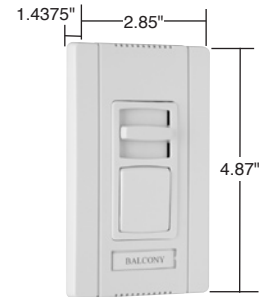

CD4FB73P120277W
Narrow

Catalog Number	Description	Ratings	Narrow or Wide	Color
NEW	Fluorescent			
CD4FB7120277I CD4FB7120277W CD4FB7120277 CD4FB7120277GRY CD4FB7120277BK CD4FB7120277LA	Single Pole, Slide-to-OFF	120/277V, 7A	Narrow	Ivory White Brown Gray Black Light Almond
CD4FB73P120277I CD4FB73P120277W CD4FB73P120277 CD4FB73P120277GRY CD4FB73P120277BK CD4FB73P120277LA	Single Pole/3-Way, Preset	120/277V, 7A	Narrow	Ivory White Brown Gray Black Light Almond
PWP2120	Power pack for switching load up to 20A	120V	—	
PWP2277	Power pack for switching load up to 20A	277V	—	

Available Spring 2009.

Pass & Seymour



Commercial Dimmers & Fan Speed Controls Titan™ Series Fan Speed Controls

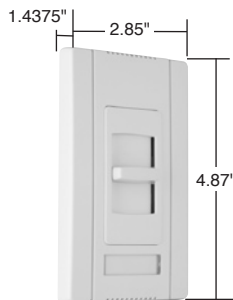

CDSC6W
Narrow

Features

- Field configurable wall plate system.
- Labeling system.
- Shipped with protective film.
- Rugged construction.
- Simple to plan the rough-in.
- Available in single pole slide-to-OFF models.
- Attractive European styling.
- Eye-catching packaging.
- Exclusive adaptor kit to install other Decorator opening devices under the Titan™ wall plate system. (See Page N-29.)
- Available in both continuously variable and de-hummer styles.
- Blank center plate included.



Catalog Number	Description	Ratings	Narrow or Wide	Color
Fan Speed Controls				
CDSC6I CDSC6W CDSC6 CDSC6GRY CDSC6BK CDSC6LA	Continuously Variable Speed Fan Speed Control	120V, 6A	Narrow	Ivory White Brown Gray Black Light Almond
CDSC12I CDSC12W CDSC12 CDSC12GRY CDSC12BK CDSC12LA	Continuously Variable Speed Fan Speed Control	120V, 12A	Wide	Ivory White Brown Gray Black Light Almond
CDDH16I CDDH16W CDDH16 CDDH16GRY CDDH16BK CDDH16LA	De-Hummer, 4 Speed Low/Low-Mid/High-Mid/High Fan Speed Control	120V, 1.6A	Narrow	Ivory White Brown Gray Black Light Almond

Commercial Dimmers & Fan Speed Controls Rotary Dimmers

Pass & Seymour



Features	
<ul style="list-style-type: none"> Full range rotary dimming. Low-voltage and fluorescent models have field adjustable trims that may be set to control minimum light level. Ground lead provided on all models. New attractive knob design. 	<ul style="list-style-type: none"> Voltage compensation circuitry in fluorescent and magnetic low-voltage model reduces lighting fluctuations. All models fit standard toggle wall plate. All dimmers on this page may be ganged without de-rating. RFI protected.

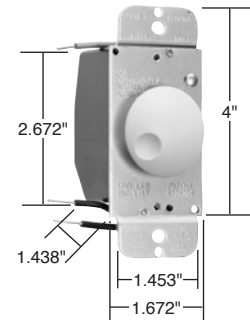

90621

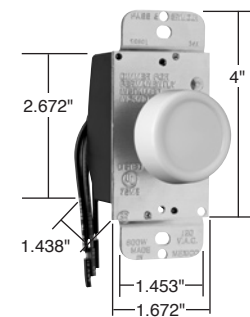

95600

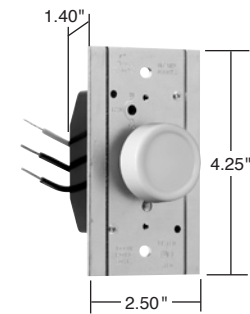

91101

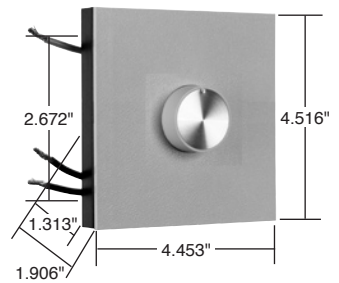

91500 91503
91501 92001

Catalog Number	Description	Ratings	Color
Incandescent Specification Grade Rotary Dimmers — Single Pole			
90621IV 90621WV	Low Profile, Dial ON/OFF	120V, 600W max.	Ivory White
Magnetic Low-Voltage Specification Grade Rotary Dimmers — Single Pole*			
95600I 95600W	Preset, Push ON/OFF	120V, 600W max.	Ivory White

*For use with magnetic transformer incandescent low-voltage lighting.

Catalog Number		Description	Ratings	Color
Single Pole	Three-Way			
1000W Max. Incandescent Heavy Use Rotary Dimmers*				
91101I 91101W		Dial, ON/OFF	120V 1000W max.	Ivory White
1000W Max. Incandescent Rotary Dimmers with Architectural Heat Sink				
91000I 91000W	91003I 91003W	Preset, Push ON/OFF	120V 1000W max.	Ivory White
91001I 91001W		Dial, ON/OFF	120V 1000W max.	Ivory White
1500W Max. Incandescent Rotary Dimmers with Architectural Heat Sink				
91500I	91503I 91503W	Preset, Push ON/OFF	120V 1500W max.	Ivory White
91501I 91501W		Dial, ON/OFF	120V 1500W max.	Ivory White
2000W Max. Incandescent Rotary Dimmers with Architectural Heat Sink				
92001I 92001W		Dial, ON/OFF	120V 2000W max.	Ivory White

*Fits in standard toggle wall plate opening.

Catalog Number	Description	Ratings	Color
1000VA Max. Magnetic Low-Voltage Specification Grade Single Pole Rotary Dimmer* with Architectural Heat Sink			
95100I	Dial, ON/OFF	120V, 1000VA max.	Ivory

* For use with magnetic transformer incandescent low-voltage lighting.

Catalog Number	Description	Color
Accessories for Rotary Heat Sink Dimmers & Fan Speed Controls		
DAPK1I DAPK1W DAPK1	1-Gang Wall Plate – Plate and Knob Kit	Ivory White Brown
DAPK2I DAPK2W DAPK2	2-Gang Wall Plate – Plate and Knob Kit	Ivory White Brown

For wiring diagrams, see Page U-24. For de-rating chart, see Page N-25.

All devices listed on this page conform to NEMA WD-1 and WD-6. UL Listed and CSA Certified.

Pass & Seymour

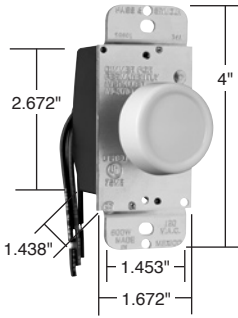

- N** 94301
- P** 94503
- N** 94601

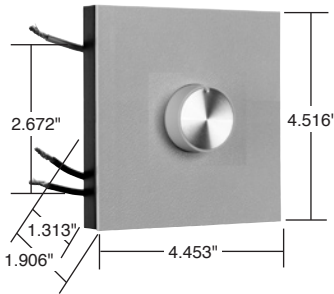

N94121

- P** = Preset
- N** = Non-Preset

Max. Load Rating	Gang Reduction	
	One Side	Two Side
De-Rating Chart		
5 Amp	4 Amp	3 Amp
8 Amp	7 Amp	6 Amp
12 Amp	11 Amp	10 Amp

Commercial Dimmers & Fan Speed Controls Rotary Fan Speed Controls

Field Adjustable Trim

This feature allows the user to set the minimum speed level desired and helps prevent damage to motor due to stalling. Models without field adjustable trims feature factory settings for minimum anti-stall levels.

Full-On Bypass

When control is placed in the full-On position, speed control circuitry is bypassed by latching contacts. This feature allows for 100% motor output and extends speed control's life by eliminating heat build-up.

Features

- Full range speed control.
- Utilizes standard toggle wall plates.
- 100% tested for symmetry for extended fan life.
- Ground lead provided.
- Ferrite bar coil choke for excellent RFI suppression.

Catalog Number	Description	Ratings	Color
3, 5 & 6A Max. Rotary Fan Speed Controls			
94301I* 94301WV** 94301LA*	Dial (Non-RFI), May Be Ganged Without De-Rating	120V 3A max.	Ivory White Light Almond
94503I*	Preset, Push On/Off, Adjustable Trim, 3-Way May Be Ganged Without De-Rating	120V 5A max.	Ivory
94601I* 94601WV**	Dial, Adjustable Trim, May Be Ganged Without De-Rating	120V 6A max.	Ivory White

* Available in VisionPak™ packaging, add "V" to Catalog Number. Example: 94301LAV.

** Available in VisionPak™ only.

Features

- Full range variable low to high speed control.
- Easily ganged by removing scored heat sink fins.
- Heavy-duty toroid choke for RFI suppression.
- Black anodized heat sink for greater heat dispersion and enhanced appearance.
- 100% tested for symmetry for extended fan life.
- Ground lead provided.
- Ferrite bar coil choke for excellent RFI suppression.

Catalog Number	Description	Ratings	Color
8 & 12A Max. Rotary Fan Speed Controls with Architectural Heat Sink			
94801I	Dial, Adjustable Trim, 1 Gang Heat Sink	120V, 8A max.	Ivory
94121I	Dial, Adjustable Trim, 2 Gang Heat Sink	120V, 12A max.	Ivory

Catalog Number	Description	Color
Accessories for Rotary Dimmers & Fan Speed Controls		
RRKCLGV RRKIGV RRKWGV	Knob Replacement for Rotary Dimmers/Fan Controls	Clear/Gold Insert Ivory/Gold Insert White/Gold Insert
RRKIV RRKLAV RRKWV		Ivory Light Almond White
Accessories for Rotary Heat Sink Dimmers & Fan Speed Controls		
DAPK1I DAPK1W DAPK1	1-Gang Wall Plate – Plate and Knob Kit for Rotary Heat Sink Devices	Ivory White Brown
DAPK2I DAPK2W DAPK2		2-Gang Wall Plate – Plate and Knob Kit for Rotary Heat Sink Devices

Residential Fan Speed Controls LightSense™ RF Wireless & Matching Wired Fan Speed Controls

Pass & Seymour



How to Pick the Right Fan Speed Control

Continuously Variable Fan Speeds – Up to 12A, can control multiple fans, may cause fan motors to hum.

De-Hummer Fan Speeds – Up to 1.6A, can control one fan only, keeps fan motors from humming.

For wiring diagrams, see Page U-24.

Features	
<ul style="list-style-type: none"> No control wiring necessary. Topdog™ RF communication protocol; 900MHz radio, bidirectional. Large surface-mounted antenna ensures maximum broadcast coverage. Stores room and house scenes. 	<ul style="list-style-type: none"> Neutral required. Power failure restore to last used level. Patented overload and short circuit protection. Compatible with Decorator wall plates. 5-year warranty. Provide previous speed recall (preset).

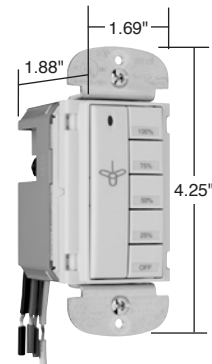

PSWCFLA

Catalog Number	Description	Voltage	Max. Watt	Load	Color
NEW	Wireless De-Hummer* Fan Speed Controls				
PSWCFI PSWCFW PSWCFBK PSWCFLA	RF Wireless Fan Speed Control	120V	—	1.5A	Ivory White Black Light Almond

* Feature specially designed capacitive circuitry to virtually eliminate fan motor "hum."

PSWCF Wiring Diagram

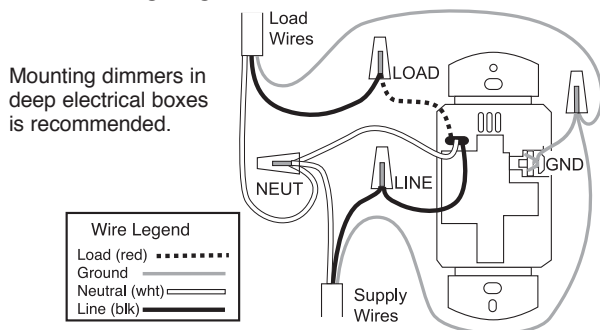

Catalog Number	Description	Voltage	Watt/Amp at 120V	Watt at 277V	Color
NEW	Wired De-Hummer* Fan Speed Controls				
PSHCFI PSHCFW PSHCFBK PSHCFLA	De-Hummer Fan Speed Control	120V	1.5A	—	Ivory White Black Light Almond

* Feature specially designed capacitive circuitry to virtually eliminate fan motor "hum."

For LightSense™ complete lighting control system including remotes, masters, and wiring diagrams, see Pages N-4 – N-10.

For more information about LightSense™ layout and programming, consult the Specification & Design Guide (part no. BR1579) and the Wireless Installation Guide (part no. FY1623).

All devices listed on this page conform to NEMA WD-1 and WD-6. cULus Listed.

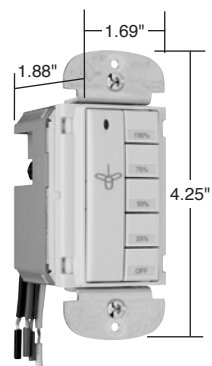

PSHCFLA

Pass & Seymour

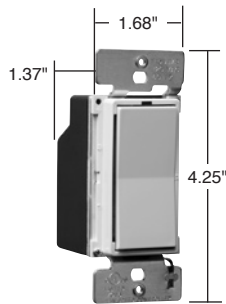

SCDH15LAV

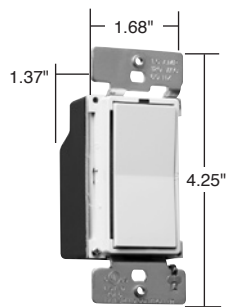

DDH15MLAV

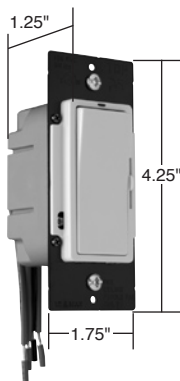

DDH16PLA

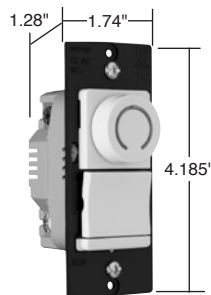

DRSC53PWV

Residential Fan Speed Controls Scene Director, Leandro[®], Harmony[™] & Rotary DR Series Fan Speed Controls

Catalog Number	Description	Ratings	Color
Scene Director 1.5A De-Hummer* Fan Speed Controllers			
SCDH15IV SCDH15WV SCDH15LAV	Preset, Controls 1 Fan Load in a Scene	120V, 1.5A	Ivory White Light Almond

*Feature specially designed capacitive circuitry to virtually eliminate fan motor "hum."

For additional Scene Director products including remotes, masters, and wiring diagrams, see Pages N-11 and N-12.

Catalog Number	Description	Ratings	Color
Leandro[®] 1.5A De-Hummer* Fan Controls			
DDH15MIV DDH15MWV DDH15MLAV	Preset, Single Pole, 3-Speed	120V, 1.5A	Ivory White Light Almond

*Feature specially designed capacitive circuitry to virtually eliminate fan motor "hum."

For additional Leandro[®] products including remotes, masters, and wiring diagrams, see Page N-13.

Catalog Number	Description	Ratings	Color
NEW Harmony[™] 1.6A De-Hummer* Fan Speed Controls			
DDH16PW DDH16PI DDH16PLA DDH16P DDH16PBK	De-Hummer Fan Speed Control	120V, 1.6A	White Ivory Light Almond Brown Black

*Feature specially designed capacitive circuitry to virtually eliminate fan motor "hum."

For additional Harmony[™] products and information, see Page N-14.

Residential & Light Commercial Fan Speed Controls

Catalog Number	Description	Ratings	Color
NEW DR Series 5A Continuously Variable Preset Fan Speed Controls			
DRSC53PIV DRSC53PPWV DRSC53PV DRSC53PBKV DRSC53PLAV	Single Pole/3-Way Fan Speed Control	120V, 5A	Ivory White Brown Black Light Almond
NEW DR Series 1.6A 3-Speed De-Hummer* Preset Fan Speed Controls			
DRDH163PIV DRDH163PWV DRDH163PV DRDH163PBKV DRDH163PLAV	Single Pole/3-Way Fan Speed Control with back-lit speed indication	120V, 1.6A	Ivory White Brown Black Light Almond

*Feature specially designed capacitive circuitry to virtually eliminate fan motor "hum."

For additional Decorator Rotary DR Series products and information, see Page N-18.

All devices listed on this page conform to NEMA WD-1 and WD-6. UL Listed and CSA Certified.

Residential & Light Commercial Fan Speed Controls LS Series Fan Speed Controls

Pass & Seymour



Catalog Number	Description	Ratings	Color
Decorator Slide Fan Speed Controls*			
<div style="display: flex; align-items: center;"> <div style="margin-right: 5px;"> <div style="background-color: red; color: white; padding: 2px; font-size: 8px;">NEW</div> <div style="background-color: red; color: white; padding: 2px; font-size: 8px;">NEW</div> </div> <div> LSSC5I LSSC5W LSSC5 LSSC5BK LSSC5LA </div> </div>	Non-Preset, Single Pole, Adjustable Trim	120V 5A	Ivory White Brown Black Light Almond
<div style="display: flex; align-items: center;"> <div style="margin-right: 5px;"> <div style="background-color: red; color: white; padding: 2px; font-size: 8px;">NEW</div> <div style="background-color: red; color: white; padding: 2px; font-size: 8px;">NEW</div> </div> <div> LSSC5PI LSSC5PW LSSC5P LSSC5PBK LSSC5PLA </div> </div>	Preset, Single Pole, Adjustable Trim	120V 5A	Ivory White Brown Black Light Almond
Decorator Slide De-Hummer Controls**			
<div style="display: flex; align-items: center;"> <div style="margin-right: 5px;"> <div style="background-color: red; color: white; padding: 2px; font-size: 8px;">NEW</div> <div style="background-color: red; color: white; padding: 2px; font-size: 8px;">NEW</div> </div> <div> LSDH16IV LSDH16WV LSDH16V LSDH16BKV LSDH16LAV </div> </div>	Non-Preset, 4-Speed Fan Control	120V 1.6A	Ivory White Brown Black Light Almond
Dual Control Decorator Slides**			
<div style="display: flex; align-items: center;"> <div style="margin-right: 5px;"> <div style="background-color: red; color: white; padding: 2px; font-size: 8px;">NEW</div> <div style="background-color: red; color: white; padding: 2px; font-size: 8px;">NEW</div> </div> <div> LSDC16IV LSDC16WV LSDC16V LSDC16BKV LSDC16LAV </div> </div>	Non-Preset, 3-Speed De-Hummer Fan Control With Single Pole Dimmer	120V 1.6A/300W	Ivory White Brown Black Light Almond
<div style="display: flex; align-items: center;"> <div style="margin-right: 5px;"> <div style="background-color: red; color: white; padding: 2px; font-size: 8px;">NEW</div> <div style="background-color: red; color: white; padding: 2px; font-size: 8px;">NEW</div> <div style="background-color: red; color: white; padding: 2px; font-size: 8px;">NEW</div> <div style="background-color: red; color: white; padding: 2px; font-size: 8px;">NEW</div> <div style="background-color: red; color: white; padding: 2px; font-size: 8px;">NEW</div> </div> <div> LSDC163PIV LSDC163PWV LSDC163PV LSDC163PBKV LSDC163PLAV </div> </div>	Preset, 3-Speed De-Hummer Fan Control With Single Pole 3-Way Dimmer	120V 1.6A/300W	Ivory White Brown Black Light Almond
<div style="display: flex; align-items: center;"> <div style="margin-right: 5px;"> <div style="background-color: red; color: white; padding: 2px; font-size: 8px;">NEW</div> <div style="background-color: red; color: white; padding: 2px; font-size: 8px;">NEW</div> </div> <div> LSDV25IV LSDV25WV LSDV25V LSDV25BKV LSDV25LAV </div> </div>	Non-Preset, Variable Speed Fan Control With Single Pole Dimmer	120V 2.5A/300W	Ivory White Brown Black Light Almond

* Available in VisionPak™ packaging, add "V" to Catalog Number. Example: LSSC5IV.

** Available in VisionPak™ only.

Feature specially designed capacitive circuitry to virtually eliminate fan motor "hum."

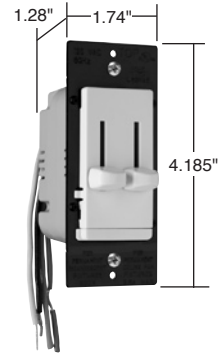

LSDC16LAV

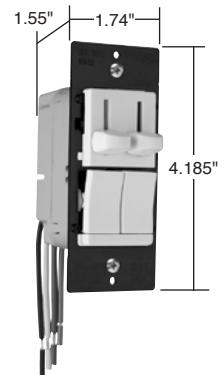

LSDC163PLAV



TM8LMCC

Catalog Number	Rating A. VAC	Color
Snap-In Light Module		
TM8LMCC	15 120/125	Clear

Catalog Number	Description	Color
Accessories for LS Series		
LRKIV LRKWV LRKV LRKBKV LRKLAV	Replacement Knobs for Decorator Dual Slides	Ivory White Brown Black Light Almond
LLRKIV LLRKWV LLRKV LLRKBKV LLRKLAV	Large Replacement Knobs for Decorator Single Slides	Ivory White Brown Black Light Almond

For additional LS Series products and information, see Pages N-15 – N-17.

All devices listed on this page conform to NEMA WD-1 and WD-6. UL Listed and CSA Certified.

Pass & Seymour

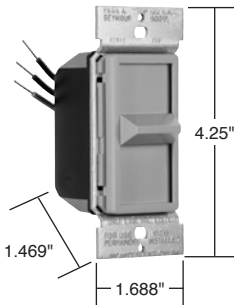

P 94580
N 94581

P = Preset
N = Non-Preset

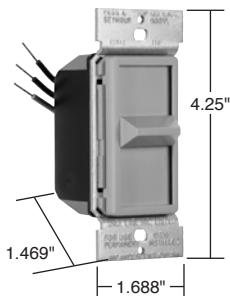

94084

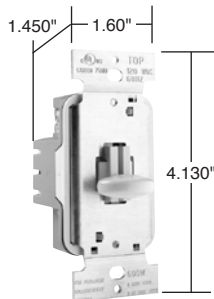

SS600W
SSSC5W

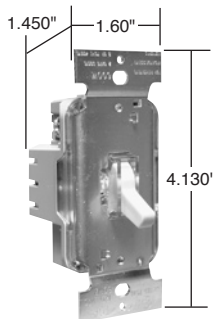

T600I
TSC5I

Residential & Light Commercial Fan Speed Controls Wide & Short Slide & Toggles

Full-ON Bypass

When the dimmer or control is placed in the full-ON position, the dimming or speed control circuitry is bypassed by latching contacts. This feature allows for 100% motor output and extends dimmer or speed control's life by eliminating heat build-up.

Field Adjustable Trim

This feature allows the user to set the minimum speed level desired and helps prevent damage to motor due to stalling. Models without field adjustable trims feature factory settings for minimum anti-stall levels.

Catalog Number	Description	Ratings	Color
5A Max. Wide Slide Fan Speed Controls			
94580I 94580W	Preset, Full-ON Bypass, Adjustable Trim May Be Ganged Without De-Rating	120V 5A max.	Ivory White
94581I* 94581W* 94581LAV**	Non-Preset, Full-ON Bypass, Adjustable Trim, May Be Ganged Without De-Rating	120V 5A max.	Ivory White Light Almond

* Available in VisionPak™ packaging, add "V" to Catalog Number. Example: 94581IV.

**Available in VisionPak™ only.

No-Noise De-Hummers

Since the development of variable fan speed controls, many fans have made an annoying humming noise when their speed was reduced. Through the use of specially designed capacitive circuitry, these units can control fans at 3 or 4-speed levels in slide, rotary, and dual styles with virtually no fan motor noise.

Catalog Number	Description	Ratings	Color
1.5A Max. No-Noise De-Hummer Specification Grade Wide Slide Fan Speed Controls – RFI Protected			
94084I* 94084W* 94084GRY 94084LA*	3-Speed, Single Pole	120V 1.5A max.	Ivory White Gray Light Almond

* Available in VisionPak™ packaging, add "V" to Catalog Number. Example: 94084LAV.

For additional Wide Slide products and information, see Pages N-19 and N-20.

Residential Fan Speed Controls

Catalog Number	Description	Ratings	Color
TradeMaster® Short Slide Fan Speed Controls*			
SSSC5I SSSC5W SSSC5LA	Non-Preset, Adjustable Trim	120V 5A	Ivory White Light Almond

* Available in VisionPak™ packaging, add "V" to Catalog Number. Example: SS600LAV.

Catalog Number	Description	Ratings	Color
TradeMaster® Toggle Fan Speed Controls*			
TSC5I TSC5W TSC5LA	Non-Preset, Adjustable Trim	120V 5A	Ivory White Light Almond

* Available in VisionPak™ packaging, add "V" to Catalog Number. Example: SS600LAV.

For additional TradeMaster® Short Slide & Toggle products and information, see Pages N-21 and N-23.

Residential Fan Speed Controls Rotary Fan Speed Controls

Pass & Seymour



No-Noise De-Hummers

Since the development of variable fan speed controls, many fans have made an annoying humming noise when their speed was reduced. Through the use of specially designed capacitive circuitry, these units can control fans at 3 or 4-speed levels in slide, rotary and dual styles with virtually no fan motor noise.

Catalog Number	Description	Ratings	Color
1.5A Max. Specification Grade Rotary Fan Speed Controls – No-Noise De-Hummers, RFI Protected*			
94003I 94003W 94003LA	3-Speed, Low-Medium-High	120V 1.5A max.	Ivory White Light Almond
94004CL 94004I 94004W 94004LA	4-Speed, Low-High	120V 1.5A max.	Clear Ivory White Light Almond

* Available in VisionPak™ packaging, add "V" to Catalog Number. Example: 94003LAV.

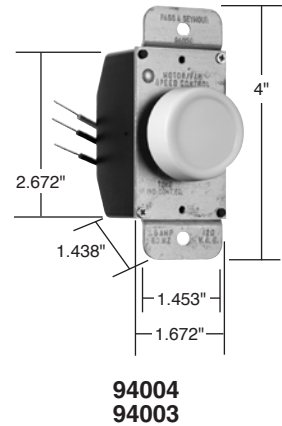

Dual Control Features

- Fits one gang box. ■ Decorator styling.
- Controls both fan speed and light level.

Catalog Number	Description	Ratings	Color
1.5A/300W Max. Specification Grade Dual Controls – No-Noise De-Hummers*			
94315I 94315W 94315LA	3-Speed Fan Control and 2-Level Hi/Low Dimmer	120V 1.5A/300W max.	Ivory White Light Almond
94215I 94215W 94215LA	4-Speed Fan Control and 2-Level Hi/Low Dimmer	120V 1.5A/300W max.	Ivory White Light Almond

Requires 3 wire installation.

* Available in VisionPak™ packaging, add "V" to Catalog Number. Example: 94315LAV.

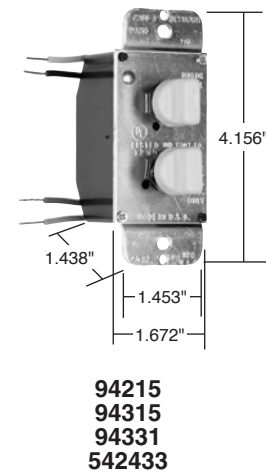

Catalog Number	Description	Ratings	Color
3A/300W Max. Specification Grade Dual Controls*			
94331I 542433	Dial Speed Control and Dimmer	120V 3A/300W max.	Ivory White

* Available in VisionPak™ packaging, add "V" to Catalog Number. Example: 94331IV.

Catalog Number	Description	Color
Accessories for Dual Controls		
109019V 109020V 109018V	Adapter Kit for Dual Fan/Light Controls	Ivory White Light Almond

Note: All controls on this page may be ganged without de-rating.

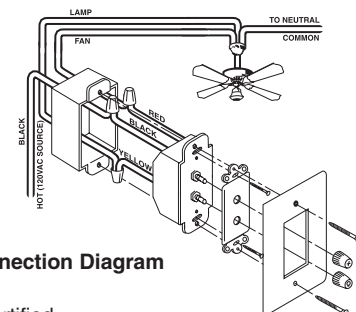

Dual Control Connection Diagram

All devices listed on this page conform to NEMA WD-1 and WD-6. UL Listed and CSA Certified.

Pass & Seymour



Commercial Fan Speed Controls

Titan™ Series Fan Speed Controls

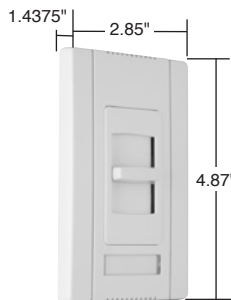

CDSC6W
Narrow

Features

- Field configurable wall plate system.
- Labeling system.
- Shipped with protective film.
- Rugged construction.
- Simple to plan the rough-in.
- Available in single pole slide-to-OFF models.
- Attractive European styling.
- Eye-catching packaging.
- Exclusive adaptor kit to install other Decorator opening devices under the Titan™ wall plate system. (See Page N-29.)
- Available in both continuously variable and de-hummer styles.
- Blank center plate included.



Catalog Number	Description	Ratings	Narrow or Wide	Color
Fan Speed Controls				
CDSC6I CDSC6W CDSC6 CDSC6GRY CDSC6BK CDSC6LA	Continuously Variable Speed Fan Speed Control	120V, 6A	Narrow	Ivory White Brown Gray Black Light Almond
CDSC12I CDSC12W CDSC12 CDSC12GRY CDSC12BK CDSC12LA	Continuously Variable Speed Fan Speed Control	120V, 12A	Wide	Ivory White Brown Gray Black Light Almond
CDDH16I CDDH16W CDDH16 CDDH16GRY CDDH16BK CDDH16LA	De-Hummer*, 4 Speed Low/Low-Mid/High-Mid/High Fan Speed Control	120V, 1.6A	Narrow	Ivory White Brown Gray Black Light Almond

* Feature specially designed capacitive circuitry to virtually eliminate fan motor "hum."

For additional Titan™ Series products and information, see Pages N-27 – N-34.

Commercial Fan Speed Controls Rotary Fan Speed Controls

Pass & Seymour



Field Adjustable Trim

This feature allows the user to set the minimum speed level desired and helps prevent damage to motor due to stalling. Models without field adjustable trims feature factory settings for minimum anti-stall levels.

Full-On Bypass

When control is placed in the full-On position, speed control circuitry is bypassed by latching contacts. This feature allows for 100% motor output and extends speed control's life by eliminating heat build-up.

Features	
<ul style="list-style-type: none"> Full range speed control. Utilizes standard toggle wall plates. 100% tested for symmetry for extended fan life. 	<ul style="list-style-type: none"> Ground lead provided. Ferrite bar coil choke for excellent RFI suppression.

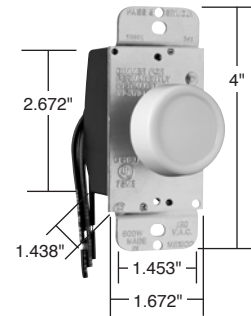

- N** 94301
- P** 94503
- N** 94601

Catalog Number	Description	Ratings	Color
3, 5 & 6A Max. Rotary Fan Speed Controls			
943011* 94301WV** 94301LA*	Dial (Non-RFI), May Be Ganged Without De-Rating	120V 3A max.	Ivory White Light Almond
945031*	Preset, Push On/Off, Adjustable Trim, 3-Way May Be Ganged Without De-Rating	120V 5A max.	Ivory
946011* 94601WV**	Dial, Adjustable Trim, May Be Ganged Without De-Rating	120V 6A max.	Ivory White

* Available in VisionPak™ packaging, add "V" to Catalog Number. Example: 94301LAV.

**Available in VisionPak™ only.

Features	
<ul style="list-style-type: none"> Full range variable low to high speed control. Easily ganged by removing scored heat sink fins. Heavy-duty toroid choke for RFI suppression. Black anodized heat sink for greater heat dispersion and enhanced appearance. 	<ul style="list-style-type: none"> 100% tested for symmetry for extended fan life. Ground lead provided. Ferrite bar coil choke for excellent RFI suppression.

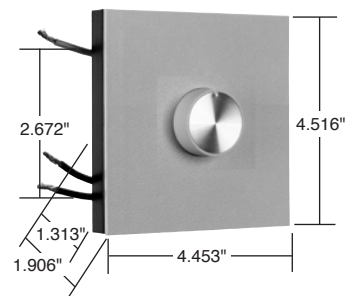

N94121

- P** = Preset
- N** = Non-Preset

Catalog Number	Description	Ratings	Color
8 & 12A Max. Rotary Fan Speed Controls with Architectural Heat Sink			
948011	Dial, Adjustable Trim, 1 Gang Heat Sink	120V, 8A max.	Ivory
941211	Dial, Adjustable Trim, 2 Gang Heat Sink	120V, w12A max.	Ivory

Catalog Number	Description	Color
Accessories for Rotary Dimmers & Fan Speed Controls		
RRKCLGV RRKIGV RRKWGV	Knob Replacement for Rotary Dimmers/Fan Controls	Clear/Gold Insert Ivory/Gold Insert White/Gold Insert
RRKIV RRKLAV RRKWV	Knob Replacement for Rotary Dimmers/Fan Controls	Ivory Light Almond White
Accessories for Rotary Heat Sink Dimmers & Fan Speed Controls		
DAPK11 DAPK1W DAPK1	1-Gang Wall Plate – Plate and Knob Kit for Rotary Heat Sink Devices	Ivory White Brown
DAPK21 DAPK2W DAPK2	2-Gang Wall Plate – Plate and Knob Kit for Rotary Heat Sink Devices	Ivory White Brown

Max. Load Rating	Gang Reduction	
	One Side	Two Side
De-Rating Chart		
5 Amp	4 Amp	3 Amp
8 Amp	7 Amp	6 Amp
12 Amp	11 Amp	10 Amp

All devices listed on this page conform to NEMA WD-1 and WD-6. UL Listed and CSA Certified.