

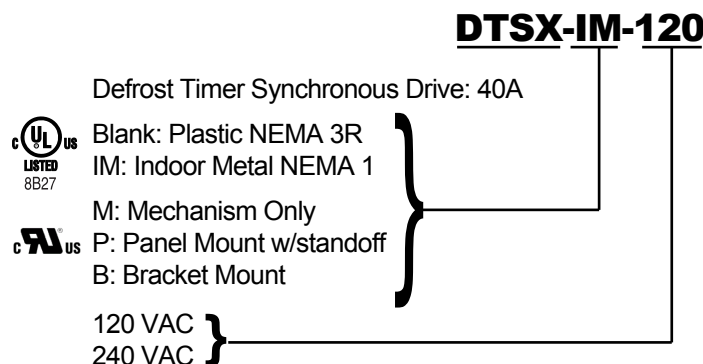

DTSX Time Initiated, Temperature, Pressure or Time Terminated 40A Defrost Timers



DTSX Time Initiated, Remote Temperature, Pressure or Time Terminated: Is used in electric or hot gas defrost applications where the defrost is terminated when the coil is frost free, as sensed by a temperature or pressure switch, even though the defrost programmed termination time has not been reached. The time termination functions as a fail-safe and will terminate the defrost if the temperature or pressure switch fails to do so. The temperature or pressure switch on the refrigeration coil have contacts which close on a temperature or pressure rise to above the freezing level, indicating that frost and ice have melted from the coil. Typically a wide differential SPDT temperature switch is used, with it's normally closed contacts wired to the fans, so that the fans are delayed from turning on after defrost termination, until the coil temperature has dropped back to below freezing. In most applications, the contacts at terminals 2-4 are normally closed (when timer is energized) and control the fans and refrigeration equipment or compressor. For hot gas defrost, or for double pole switching, the 2-4 contacts may be configured as normally open by moving jumper S1 to the "B" position. Refer to wiring diagrams 1 thru 12.

SPECIFICATIONS

Electrical Ratings:

[2] & [4] Contacts	[1] & [3] Contacts	[1] & [F] Contacts
30A Resistive	40A Resistive	30A Resistive
@120~240VAC	@120~240VAC	@120~240VAC
1HP @ 120VAC	1HP @ 120VAC	1HP @ 120VAC
2HP @ 240VAC	2HP @ 240VAC	2HP @ 240VAC

Environmental Ratings: Ambient Temperature: -40F to 130F
Humidity: 0-95% non-condensing

Wiring Connections:

Screw clamp terminals for #22AWG up to #8AWG wire.

Use #8 AWG wire with 90C rating for 40A loads.

Use #10 AWG wire with 90C rating for 30A loads.

Enclosures:

Plastic NEMA 3R Raintight Indoor/Outdoor
Metal NEMA 1 Indoor

LED Indication: Green LED when in refrigeration mode
Red LED when in defrost mode

APPLICATION

The DTSX Defrost Timer is identical in function, terminal identification, and wiring to the Paragon 8140 and Precision 6140 series Defrost Timers. The DTSX may also be used to replace Paragon 8040 and Precision 6040 series time terminated defrost timers. With the addition of a remote pressure switch, the DTSX can replace the Paragon 8240 series and Precision 6240 series pressure terminated defrost timers.

Defrosts will be initiated at the times set on the timer, which will accept from 1 to over 24 defrost initiation settings per day at 15 minute intervals (8:00AM, 8:15AM, 8:30AM, etc.) Defrost duration is settable in 15 minute intervals from a minimum of 15 minutes up to several hours (15 minutes, 30 minutes, 45 minutes, 1 hour, 1 hour-15 minutes, etc.) The defrost duration determines the termination time.

In standard configuration, the contacts between terminals 1 and 3 are normally open and close during a defrost to energize defrost heaters; the contacts between terminals 2 and 4 are normally closed (when timer is energized) and open during a defrost to de-energize refrigeration and fans.

Ø Terminal: The DTSX contains a normally closed contact between terminals 1-F. This terminal may be used for switching the fans off during a defrost rather than the 2-4 terminals. For hot gas defrost applications, with S1 in the "B" position, the fans may be connected to the "F" terminal.

INSTALLATION

Note: For outdoor locations, Raintight or wet location conduit hubs that comply with requirements of UL 514B (standard for fittings for conduit and outlet boxes) are to be used.

1. Remove 2 screws retaining the interior cover panel and remove panel by prying out with a thin blade (NEMA3R).
2. Select knockouts to be used. Remove the inner (1/2") knockout by inserting a screwdriver in the slot and carefully punch knockout loose. Remove slug. If the 3/4" knockout is required, remove the outer ring with pliers after removing the 1/2" knockout. Smooth edges with knife if necessary.
3. Place enclosure in desired mounting location and mark the three mounting holes.
4. Drill holes for #10 screws, start screws in holes.
5. Place enclosure over screws and tighten screws.
6. Connect conduit hubs to conduit before connecting the hubs to the enclosure. After inserting hubs into enclosure, carefully tighten hub lock nut. Do not over-torque.
7. If using NEMA1 Metal Enclosure connect ground wires to ground lug on bottom of enclosure. (Not applicable for NEMA3R plastic enclosure).
8. Wire in accordance with National and Local Codes.
9. Replace interior cover panel and 2 screws (NEMA3R).

Grounding: NEMA 3R enclosure is of plastic construction and does not require a ground connection or bonding.

NEMA3R enclosure does not provide grounding between conduits. When using non-metallic conduit or cable, connect the ground wires of all cables together with a wire nut. When metallic conduit is used, use grounding type bushings and a jumper wire between each conduit.

CAUTION: Do not check circuits by ØparkingØ wires to terminals. Damage to the defrost timer may result.

PROGRAMMING (Synchronous and Quartz Electromechanical Models)

Setting the Time:

Turn the minute hand clockwise until the time of day (and AM or PM) on the outer dial is aligned with the triangle marker on the inner dial.

DO NOT ROTATE MINUTE HAND COUNTER-CLOCKWISE

Setting Defrost Initiation Time:

Move a white tab (tripper) on the outer dial outward at each desired initiation time. For example, to set defrost initiation times at 6:00AM, 11:30AM, 4:30PM and 11:00PM, move the tab adjacent to the "M" in AM on the dial (6:00AM), the tab that lies between 11:30AM and 11:45 AM, the tab between 4:30PM and 4:45PM, and the tab adjacent to the 11:00-11:15PM marks. (See note for 8243/6243 replacement.)

Setting Maximum Defrost Duration:

Different defrost durations may be set for each defrost initiation setting. Each white tab (tripper) provides a 15 minute interval. The tabs that set the initiation time provide a minimum of 15 minutes of defrost. For longer defrost duration, move additional tabs (following in time) from the initiation tab. For example, if a 45 minute defrost is to start at 7:00AM, move the tab outward that lies between 7:00 and 7:15 on the AM side of the dial, and the tabs adjacent to 7:15-7:30 and 7:30-7:45. (3 tabs moved outward). The defrost will initiate at 7:00AM and time terminate at 7:45AM (if temperature termination does not occur first.)

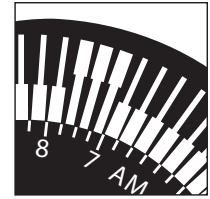

For electronic models, refer to separate programming instructions.

IMPORTANT INFORMATION: The Normally Closed contacts between terminals 2 and 4 are only closed when the defrost timer is energized. The 2-4 contacts are the Normally Open contacts of relay K2. (Normal Open relay contacts are more reliable than Normally Closed). When checking continuity of the control with no voltage applied, the 2-4 contacts will appear as open; this is normal. The 1-3 contacts will appear as open and the 1-F contacts will appear as closed. We recommend that the control be tested by using a voltmeter, with rated voltage applied.

Note: A definite purpose contactor must be used to switch loads greater than the following maximum loads:

Max. Defrost Heater Load:	120V: 4800Watts	Max. Fan & Compressor Load:	120V: 1HP
	208V: 8320Watts		208/240V: 2HP
	240V: 9600Watts	Max. Fan Load on Terminal "F"	120V: 1HP
			208/240V: 2HP

TYPICAL WIRING DIAGRAMS

All switch positions are shown in refrigeration cycle operation, and change position upon initiation of a defrost.

DTSX Time/Time - Electric Defrost Wiring Diagram

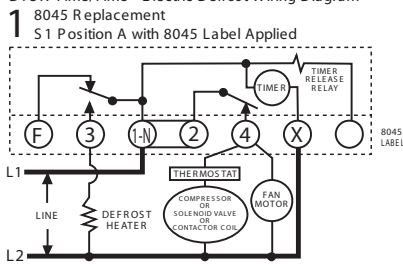

DTSX Time/Time - Electric Defrost Wiring Diagram

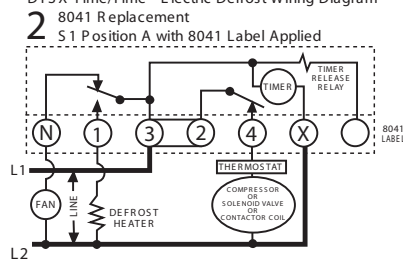

DTSX Time/Time - Hot Gas Defrost Wiring Diagram

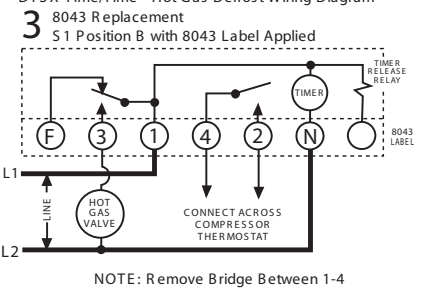

DTSX Time/Time - Electric Defrost Wiring Diagram

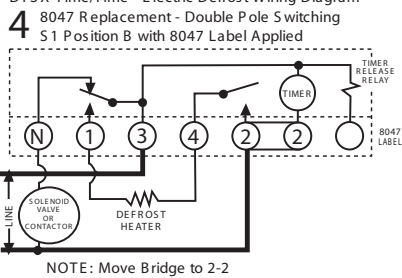

DTSX Time/Temp. - Electric Defrost Wiring Diagram

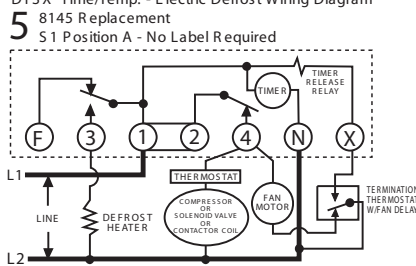

DTSX Time/Temp. - Electric Defrost Wiring Diagram

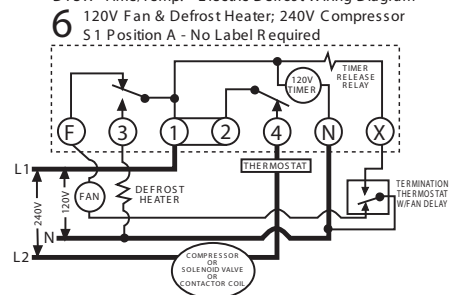

DTSX Time/Temp. - Electric Defrost Wiring Diagram

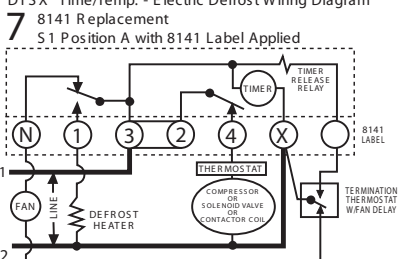

DTSX Time/Temp. - Hot Gas Defrost Wiring Diagram

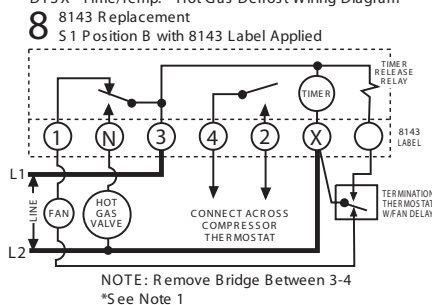

DTSX Time/Temp. - Electric Defrost Wiring Diagram

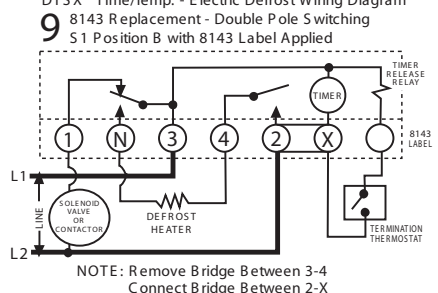

DTSX Time/Pressure-Electric Defrost Wiring Diagram

10 8245 Replacement
S1 Position A with 8245 Label Applied

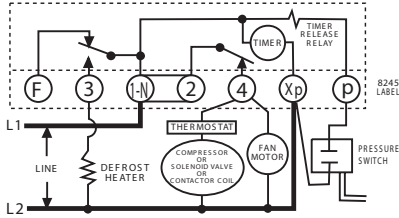

DTSX Time/Pressure-Compressor Shutdown

11 8243 Replacement
S1 Position B with Trippers Reversed

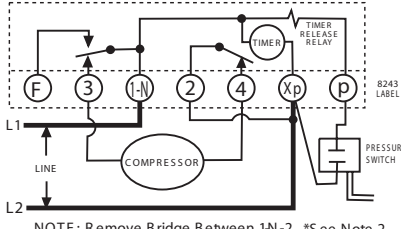

NOTE: Remove Bridge Between 1-N-2 *See Note 2

DTSX Time/Pressure-Electric Defrost Wiring Diagram

12 8247 Replacement-Double Pole Switching
S1 Position B with 8247 Label Applied

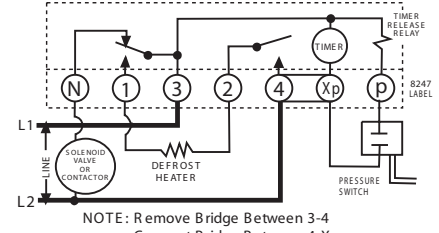

NOTE: Remove Bridge Between 3-4
Connect Bridge Between 4-Xp

REPLACING EXISTING DEFROST TIMERS

IMPORTANT: When replacing a Grasslin DT-040 model with a DTSX, the power connections must be made to terminals N and 1 on the DTSX. No connection must be made to the X terminal or damage to the unit will result. Disconnect the power wire from terminal X on the DT-040 and connect it to terminal N on the DTSX. Disconnect the other power wire from terminal N on the DT-040 and connect it to terminal 1 on the DTSX. All other wires should be connected to the DTSX the same as on the DT-040.

The DTSX will replace all models of Paragon 8040, 8140, 8240 Series or Precision 6040, 6140, 6240 Series

TERMINAL IDENTIFICATION

The standard DTSX terminal identification is identical to the Paragon 8145 with the addition of the "F" terminal. Terminal identification labels are provided for the other models to be placed over the printed numbers on the printed circuit board. From the table below, select the proper label, apply to printed circuit board, and wire per the original wiring or the wiring diagrams indicated.

MODE SELECTION (Blue Jumper)

The mode selector jumper S1 (located at lower right side of the board) determines the configuration of contacts 2-4. In position "A" the contacts are normally closed (only when the timer is energized), and will open during a defrost. In position "B" the 2-4 contacts are normally open, and will close during a defrost. Select proper position from table below, and wiring diagrams indicated. To move jumper, pull straight away from board, and reinsert over the top two pins for position "B" or the bottom two pins for position "A".

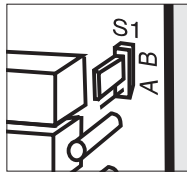

DTSX S1 Position B

Note: When S1 jumper is in "B" position the DTSX will operate as follows. Refrigeration Mode- RED & GREEN LED's will turn ON (1&3 and 2&4 break while 1&F make) Defrost Mode- RED & GREEN LED's will turn OFF (1&3 and 2&4 make while 1&F break)

8045 REPLACEMENT:

The DTSX with 8045 terminal ID label applied differs from the 8045 in that terminals 1 and N are combined. This means that the DTSX model must be the same voltage as the defrost circuit (defrost heater, contactor coil, or hot gas valve). If being used in an application where the defrost circuit is 120V and the refrigeration circuit is 240V, the DTSX must be configured for 120V application (all red jumpers insert-

ed) with 120V power connected to 1-N and X, and the bridge jumper between 1-N and 2 must be removed.

NOTE 1-8143 Replacement: When replacing a Paragon 8143 or Precision 6143, wire the termination thermostat to terminal X of the DTSX and the adjacent blank terminal. The Paragon and Precision timers are wired to terminal N and the blank terminal. If the termination thermostat is wired to terminal N of the DTSX (with the 8143 label attached), temperature termination will not occur and may result in burnout of the DTMV. See wiring diagrams 8 & 9.

8240/6240 SERIES REPLACEMENT:

The DTSX may be used to replace the Paragon 8240 or Precision 6240 series defrost timers with integral pressure termination by the addition of a remote pressure switch wired to terminals Xp and p of the DTSX (with an 8240 series terminal label applied). There must be no external voltage connected to the pressure switch. Set pressure switch cut-in to the same value as set on the Paragon or Precision defrost timer being replaced. Set cut-out 6 to 14psi below cut-in. See wiring diagrams 10, 11, and 12.

Recommended Pressure Switches: Johnson/Penn P170, Ranco 010 series, or Danfoss KP1 series. Pressure range approximately 35-110psi, CUT-IN ON PRESSURE RISE.

NOTE 2-8243 Replacement: When replacing a Paragon 8243 or Precision 6243, the DTSX white tabs (trippers) for setting defrost time and defrost duration must be reversed. Pull ALL tabs outward. Press the tabs inward at the desired defrost initiation times, and for desired duration.

Paragon Model	Precision Model	GRASSLIN Model	S1 Mode Selector	Terminal Ident. Label	Typical Wiring Diagram	Terminal Layout (see note below)
TIME INITIATED, TIME TERMINATED						
8045 8046	6045	DTSX DTSX	A A	None None	1	(F) (3) (1-N) (2) (4) (X) NO CONNECTION
8041	6041	DTSX	A	8041	2	(N) (1) (3) (2) (4) (X) NO CONNECTION
8043	6043	DTSX	B	8043	3	(F) (3) (1) (4) (2) (N) NO CONNECTION
8047	6047	DTSX	B	8047	4	(N) (1) (3) (4) (2) (2) NO CONNECTION
TIME INITIATED, REMOTE TEMPERATURE OR PRESSURE TERMINATED						
8145	6145	DTSX	A	None	5, 6	(F) (3) (1) (2) (4) (N) (X)
8141	6141	DTSX	A	8141	7	(N) (1) (3) (2) (4) (X) ()
8143	6143	DTSX	B	8143	8, 9 See Note 1	(1) (N) (3) (4) (2) (X) ()
TIME INITIATED, PRESSURE TERMINATED (Separate Pressure Switch Required - see instructions)						
8245	6245	DTSX	A	8245	10	(F) (3) (1-N) (2) (4) (Xp) (p)
8243	6243	DTSX	B	8243	11 See Note 2	(F) (3) (1-N) (2) (4) (Xp) (p)
8247	6247	DTSX	B	8247	12	(N) (1) (3) (2) (4) (Xp) (p)

NOTE: In "Terminal Layout" the connecting lines between terminals indicate the correct positions of the bridges for each model. The heavy line indicates the bridge must be installed as shown. The light line indicates the bridge may be removed if different voltages are used at each switch.

INSTALLATION IN EXISTING ENCLOSURES

NEW STYLE

1. Disconnect power.
2. Remove and save insulator from Paragon timer.
3. Disconnect wiring.
4. Remove Paragon mechanism from enclosure.
5. Remove Grasslin DT model from its enclosure.
6. If necessary, move S1 jumper and apply terminal identification label from plastic bag to DT model as per table on previous page.
7. Locate metal clip in plastic bag and assemble it to printed circuit board at notch in right side.
8. Engage tabs on left side of printed circuit board in enclosure, and swing PCB into place until tab on metal clip engages tang on Paragon enclosure.
9. Reconnect wires, tighten terminal screws securely.
10. Assemble insulator from plastic bag to Paragon insulator by interleaving as shown.
11. Place insulator assembly over mechanism, with notch and tab over retaining clip, and engaging tab in slot in tang to retain insulator.

New Style



OLD STYLE and BRACKET MOUNT

1. Disconnect power.
2. Remove and save insulator from Paragon timer.
3. Disconnect wiring.
4. Remove and save the 6-32 screw. Remove and discard two metal posts retaining Paragon mechanism.
5. Remove Paragon mechanism from enclosure.
6. Remove Grasslin DT model from its enclosure, and with pliers, break off the 3 tabs on left side of printed circuit board.
7. Remove contents of plastic bag.
8. If necessary, move S1 jumper and apply terminal identification label to DT model as per table on previous page.
9. Locate plastic 3/4" long standoff with internal threads, and using screw from Paragon timer, assemble standoff on top of upper center hole in DT board with screw through back of board.
10. Place board in Paragon enclosure with standoff aligned under hole in the enclosure's upper flange.
11. Assemble the 6-32 x 1/4" screw through the tapped hole in the enclosure's flange and into the tapped hole in the standoff. (Hold board and standoff firmly up against the flange while driving the screw).
12. Assemble the two plastic insulator retainer posts with screwdriver at two locations where metal posts were removed.
13. Reconnect wires, tighten terminal screws securely.
14. Assemble insulator from plastic bag to Paragon insulator by interleaving as shown.
15. Place insulator assembly over mechanism and press onto plastic posts.

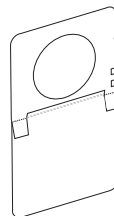

Interleave Grasslin insulator (top) with Paragon insulator as shown here

Old Style

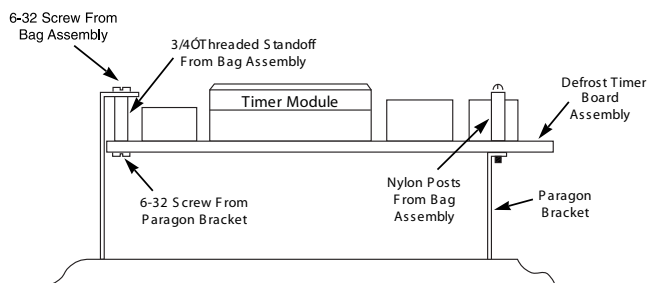
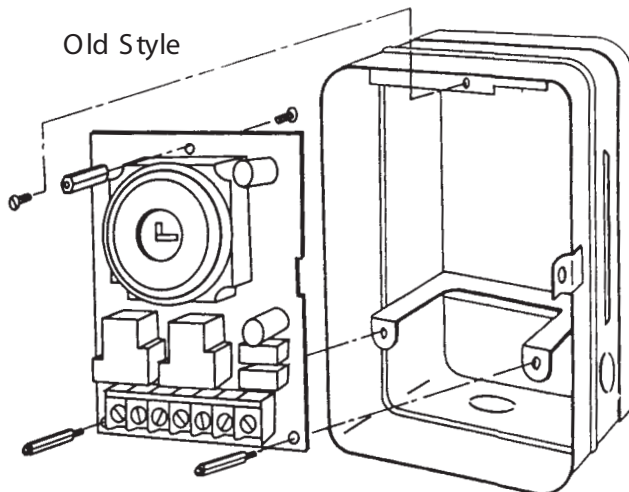

CAUTION: If the Defrost Timer board assembly is not assembled to the bracket exactly as shown above, a short may occur which will destroy the defrost timer.