

Table of Contents

Specifications.....	1
Applications.....	2
Your Water Heater Controller at a Glance.....	3
Changing the "OFF-PEAK" time period.....	4
Setting time of day (with or without glass cover in place).....	4
Mounting Instructions.....	5

1. Specifications

Installation.....	Double insulated with appliance loop-through earth terminal
Rating.....	13A, for immersion heaters up to 3 kW
Supply.....	230 VAC 50 Hz
Boost.....	Adjustable between 15 and 120 minutes
Fitting.....	Surface or flush mounted
Running reserve.....	72 hours minimum
Dimensions H x W x D (mm).....	86 x 155 x 55 (mm)
Ambient temperature.....	-10 °C ... +35 °C
Protection category.....	IP 20

2. Applications

The unit is a Water Heater Controller that controls the use of cheap-rate electricity during the night to heat the water in your tank for the following applications:

SINGLE IMMERSION HEATER

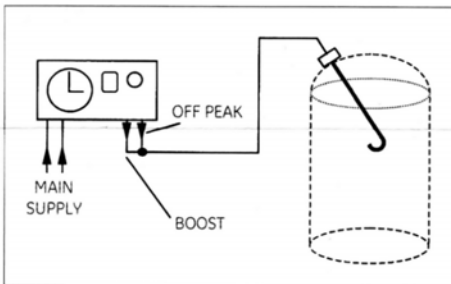

DUAL IMMERSION HEATER

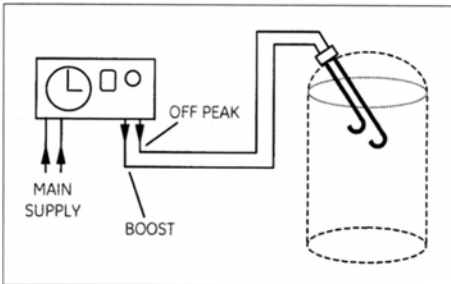

TWO IMMERSION HEATERS

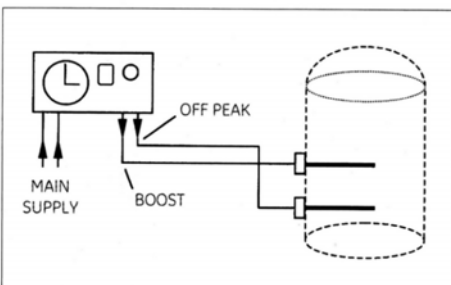

3. Your Heater Controller at a Glance

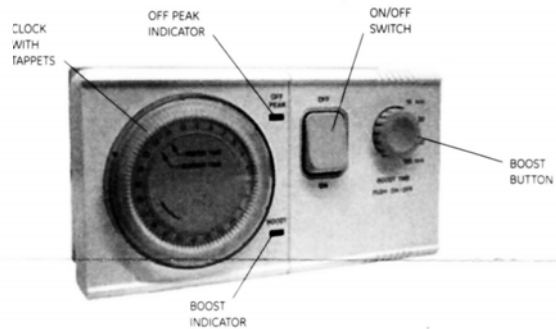

OFF PEAK INDICATOR

The indicator glows if the cheaper night-rate electricity is used.

BOOST INDICATOR

The indicator glows if a boost timer is used.

ON/OFF SWITCH

Switch is in "OFF position"

- The settings of the "OFF PEAK" and "BOOST" time period are not activated, the clock runs but the heater is disconnected.

Switch is in "ON position"

- The settings of the "OFF PEAK" and "BOOST" time period are activated and the water will be heated during the "OFF-PEAK" time period at night-time.

BOOST BUTTON

This button is only needed if you need extra hot water during the day-time "PEAK" time.

- Choose your boost time (adjustable between 15 and 120 minutes)
- Press the "BOOST BUTTON" once for switching ON.
- If you want to interrupt the boost function before the boost time is completed: Press the "BOOST BUTTON" once more.

4. Changing the "OFF-PEAK" Time Period Setting Time of Day

CHANGING THE "OFF-PEAK" TIME PERIOD

The tappets for the "OFF-PEAK" time period are pre-set at the factory (3:30 a.m. to 7:30 a.m.) However, if a different time period is required, move the tappets for the "OFF-PEAK" time period to the outer position. The minimum switching time is 15 minutes.

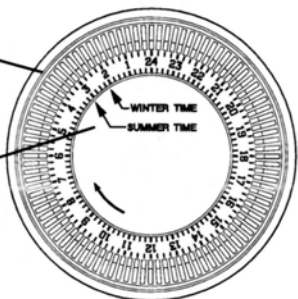

SETTING TIME OF DAY (with or without glass cover in place)

Rotate the clock (clockwise direction only) until the arrowhead indicating "WINTER TIME" or "SUMMER TIME" aligns with the correct time of day on the dial.

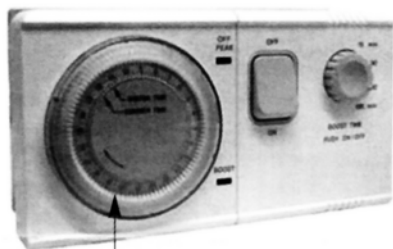

ASSEMBLE THE CLEAR COVER

Once the glass cover is located, it can only be removed using a screw driver.

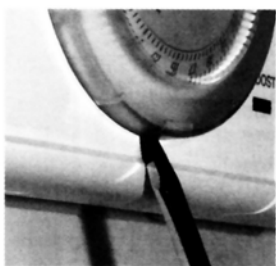

Align the bar on the edge of the cover with the groove at the lower edge of the dial in the housing. Remove the cover by applying a screw driver between groove and cover.

5. Mounting Instructions

NB A qualified electrician must carry out the installation and conform to the current IEE regulations.

NB The unit should be installed on a separate distribution circuit with appropriate overload protection

NB The Water Heater Controller is suitable for fixed wiring only. Wire size should be 1.5 mm² to 4 mm².



WARNING:

Do not terminate stranded conductor on this device. Crimps MUST be used for stranded conductors.

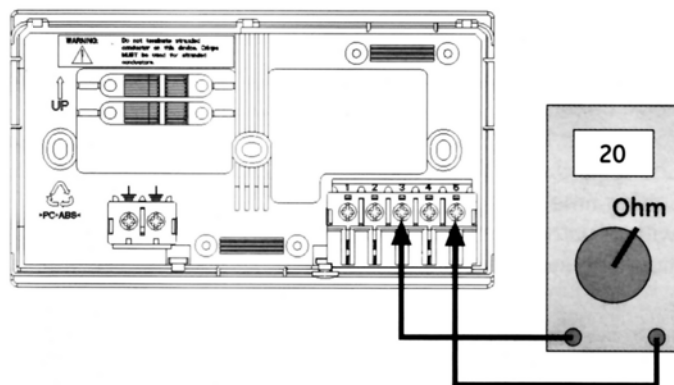

Use the connections 1 to 5 as identified.

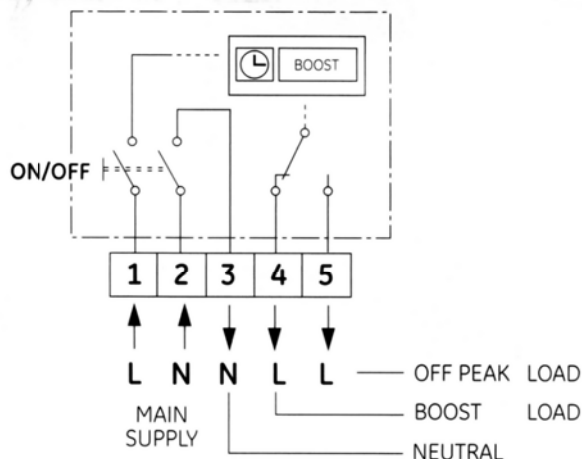

- Connect the "BOOST" immersion heater and the "OFF PEAK" immersion heater as shown above.
- Tighten wiring screws to 0.7 - 1.5 Nm torque
- Verify max load is 3 kW using ohmmeter by measuring resistance after wiring as follows:
 - Verify load between terminals 3 & 4 > 17 Ohm
 - Verify load between terminals 3 & 5 > 17 Ohm
- Plug top module into base. Verify correct insertion by confirming that the red stripe on the base is not visible. If red is visible, the module is not fully seated.

Correct

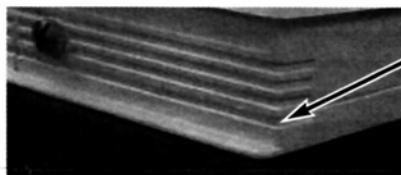

OK
no red showing

Wrong

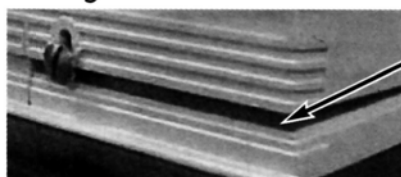

Wrong
red line showing

- Assemble the clock by aligning the location pins on the top of the back-plate with the cut-outs provided on the clock body. Lock in position using fixing screw.