

Operating Instructions

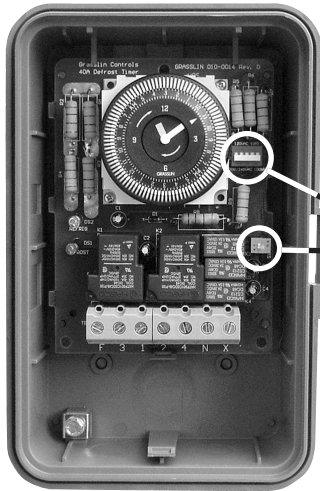

NEMA 3R Enclosure

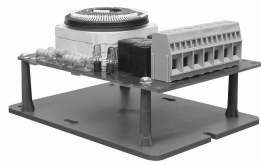

Bracket Mount



DTMV40 Time Initiated, Temperature, Pressure or Time Terminated Multi-Voltage Defrost Timers

STARTUP PROCEDURE

- Determine model to be replaced (Grasslin or Competitors) from table below.
- Set Mode Selection (S1 BLUE DIP Switch – Fig. A) See table below and instructions on page 5.
- Apply corresponding Terminal Identification and Door labels –see retrofit kit instructions.
- Set correct input voltage (S2 RED DIP Switch – Fig. B).
- Follow installation and programming instructions.

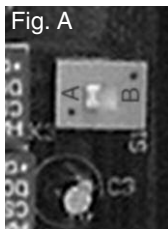

Fig. A

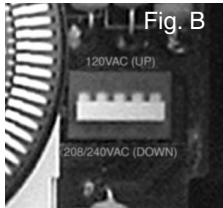

Fig. B

The DTMV40 can be configured for either 120 or 208/240VAC. Locate RED DIP Switch to the right of timer module. For:

- 120VAC slide DIP switch UP
- 208/240VAC slide DIP switch DOWN

Paragon	Precision	Mode Selection	Wiring Diag.
TIME INITIATED, TIME TERMINATED			
<input type="checkbox"/> 8045/8046	6045	A	1
<input type="checkbox"/> 8041	6041	A	2
<input type="checkbox"/> 8043	6043	B	3
<input type="checkbox"/> 8047	6047	B	4
TIME INITIATED, REMOTE TEMPERATURE OR PRESSURE TERMINATED			
<input type="checkbox"/> 8145	6145	A	5
<input type="checkbox"/> 8141	6141	A	7
<input type="checkbox"/> 8143	6143	B	8
TIME INITIATED, PRESSURE TERMINATED (Separate Pressure Switch Required (see instructions))			
<input type="checkbox"/> 8245	6245	A	10
<input type="checkbox"/> 8243	6243	B	11
<input type="checkbox"/> 8247	6247	B	12
Grasslin			
<input type="checkbox"/>	DT040	A	5
<input type="checkbox"/>	DT140	A	5
<input type="checkbox"/>	DTMV	A	5
<input type="checkbox"/>	DTSX	A	5

INSTALLATION

Note: For outdoor locations, Raintight, or wet location conduit hubs that comply with requirements of UL 514B (standard for fittings for conduit and outlet boxes) are to be used.

- Open door and then remove interior protective cover by releasing spring clip on bottom.
- Remove timer mechanism by releasing spring clip on bottom.
- Select knockouts to be used. Remove inner 1/2" knockout by inserting a screwdriver in the slot and carefully punch knockout loose. Remove slug. If 3/4" knockout is required, remove the outer ring with pliers after removing the 1/2" knockout. Smooth edges with knife if necessary.
- Place enclosure in desired mounting location and mark the three mounting holes (refer to diagram). Start by placing set screw on top and attaching enclosure over keyhole; then screw in remaining two screws on bottom.
- Connect conduit hubs to conduit before connecting the hubs to the enclosure. After inserting hubs into enclosure, carefully tighten hub lock nut. Do not over-torque.
- Verify voltage selection. 120VAC – position switch UP; 208/240VAC – position switch DOWN (refer to Fig. B).**
- Wire in accordance with National and Local Codes.
- Grounding: Terminate all ground wires to ground lug on bottom of enclosure.
- Replace interior protective cover.

CAUTION: Do not check circuits by "sparking" wires to terminals. Damage to the defrost timer may result.

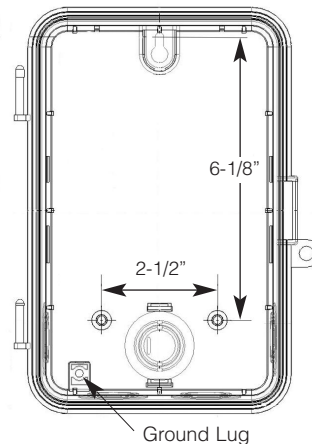
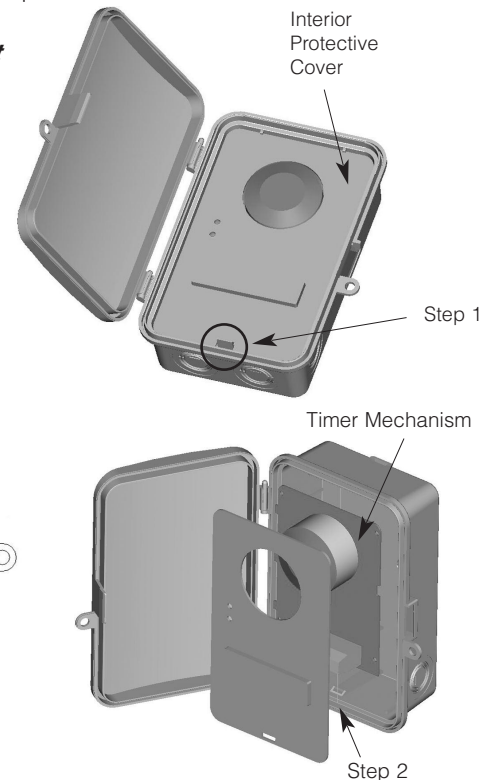

Ground Lug

Model Designation

Models	Enclosure Mount
DTMV40	24-hour, Outdoor NEMA 3R Enclosure
DTQMV40	24-hour w/Battery Backup, Outdoor NEMA 3R Enclosure
DTMV40-IM	24-hour, Indoor Metal NEMA 1 Enclosure
DTQMV40-IM	24-hour w/Battery Backup, Indoor NEMA 1 Enclosure

Models	Non-Enclosure Mount
DTMV40-M	24-hour, Mechanism Only
DTQMV40-M	24-hour w/Battery Backup, Mechanism Only
DTMV40-P	24-hour, Panel Mount
DTQMV40-P	24-hour w/Battery Backup, Panel Mount
DTMV40-B	24-hour, Bracket Mount
DTQMV40-B	24-hour w/Battery Backup, Bracket Mount

Note: All units with Battery Backup provide up to a week of reserve carryover.

PROGRAMMING (Synchronous and Quartz Electromechanical Models)

Setting the Time:

Turn the minute hand clockwise until the time of day (and AM or PM) on the outer dial is aligned with the triangle marker on the inner dial.

DO NOT ROTATE MINUTE HAND COUNTER-CLOCKWISE

Setting Defrost Initiation Time:

Move a white tab (tripper) on the outer dial outward at each desired initiation time. For example, to set defrost initiation times at 6:00AM, 11:30AM, 4:30PM and 11:00PM, move the tab adjacent to the "M" in AM on the dial (6:00AM), the tab that lies between 11:30AM and 11:45 AM, the tab between 4:30PM and 4:45PM, and the tab adjacent to the 11:00–11:15PM marks. (See note for 8243/6243 replacement.)

Setting Maximum Defrost Duration:

Different defrost durations may be set for each defrost initiation setting. Each white tab (tripper) provides a 15 minute interval. The tabs that set the initiation time provide a minimum of 15 minutes of defrost. For longer defrost duration, move additional tabs (following in time) from the initiation tab. For example, if a 45 minute defrost is to start at 7:00AM, move the tab outward that lies between 7:00 and 7:15 on the AM side of the dial, and the tabs adjacent to 7:15-7:30 and 7:30-7:45.

(3 tabs moved outward). The defrost will initiate at 7:00AM and time terminate at 7:45AM (if temperature termination does not occur first.)

For electronic models, refer to separate programming instructions.

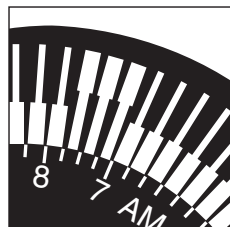

DTMV40 TROUBLESHOOTING GUIDE

MODE A (See page 1)

In Refrigeration Mode

Arrow on timer points to current time.

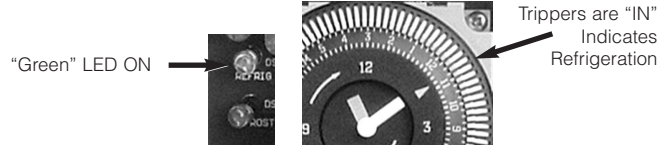

"1 & F" Make
"1 & 3" Break

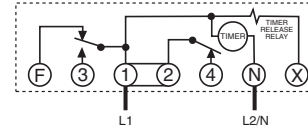

"2 & 4" Make

In Defrost Mode

Arrow on timer points to current time.

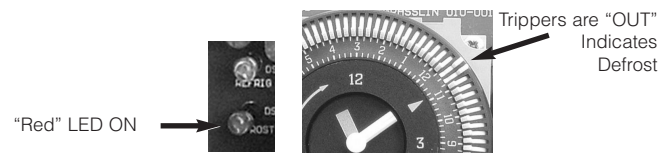

"1 & F" Break
"1 & 3" Make

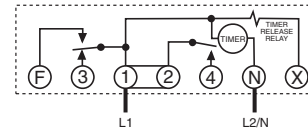

"2 & 4" Break

DTMV40 TROUBLESHOOTING GUIDE

MODE B (See page 1)

In Refrigeration Mode

Arrow on timer points to current time.



"1 & F" Make
"1 & 3" Break

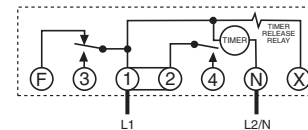

"2 & 4" Break

In Defrost Mode

Arrow on timer points to current time.



"1 & F" Break
"1 & 3" Make

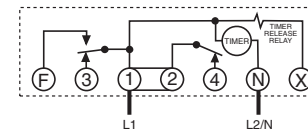

"2 & 4" Make

Note: It is necessary to apply power across terminals 1&N in order to perform electrical test.

TYPICAL WIRING DIAGRAMS

All switch positions are shown in refrigeration cycle operation, and change position upon initiation of a defrost.

DTMV40 Time/Time –Electric Defrost Wiring Diagram
1 8045 Replacement
 Mode A with 8045 Label Applied

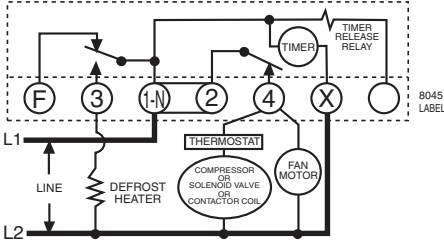

DTMV40 Time/Time–Electric Defrost Wiring Diagram
2 8041 Replacement
 Mode A with 8041 Label Applied

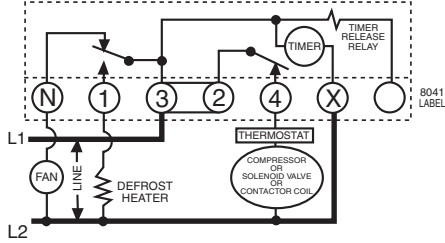

DTMV40 Time/Time–Hot Gas Defrost Wiring Diagram
3 8043 Replacement
 Mode B with 8043 Label Applied

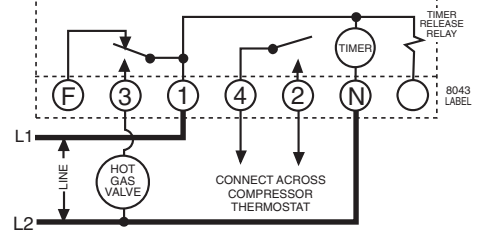

NOTE: Remove Bridge Between 1–4

DTMV40 Time/Time–Electric Defrost Wiring Diagram
4 8047 Replacement–Double Pole Switching
 Mode B with 8047 Label Applied

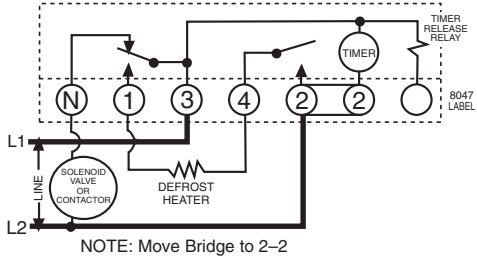

NOTE: Move Bridge to 2–2

DTMV40 Time/Temp.–Electric Defrost Wiring Diagram
5 8145 Replacement
 Mode A - No Label Required

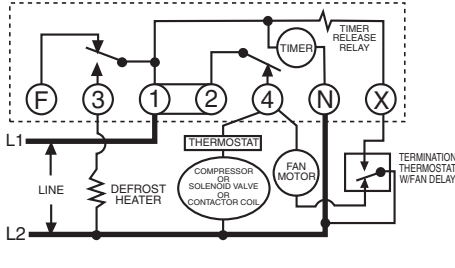

DEFAULT (Out of the Box)

DTMV40 Time/Temp.–Electric Defrost Wiring Diagram
6 120V Fan & Defrost Heater; 240V Compressor
 Mode A - No Label Required

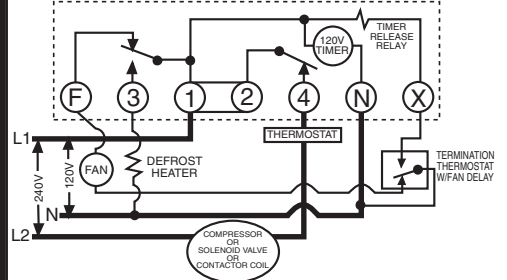

DTMV40 Time/Temp.–Electric Defrost Wiring Diagram
7 8141 Replacement
 Mode A with 8141 Label Applied

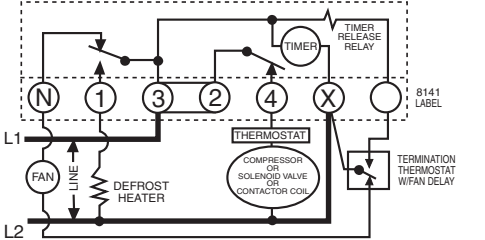

DTMV40 Time/Temp.–Hot Gas Defrost Wiring Diagram
8 8143 Replacement
 Mode B with 8143 Label Applied

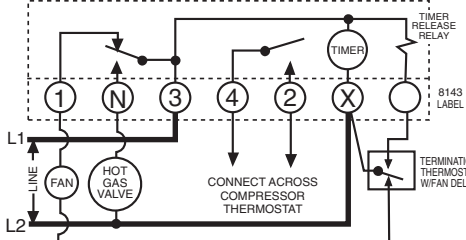

NOTE: Remove Bridge Between 3–4
 *See Note 1

DTMV40 Time/Temp.–Electric Defrost Wiring Diagram
9 8143 Replacement–Double Pole Switching
 Mode B with 8143 Label Applied

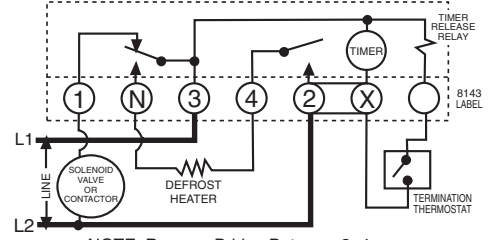

NOTE: Remove Bridge Between 3–4
 Connect Bridge Between 2–X

DTMV40 Time/Pressure–Electric Defrost Wiring Diagram
10 8245 Replacement
 Mode A with 8245 Label Applied

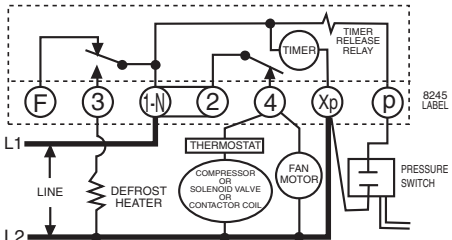

DTMV40 Time/Pressure–Compressor Shutdown
11 8243 Replacement
 Mode B with Trippers Reversed

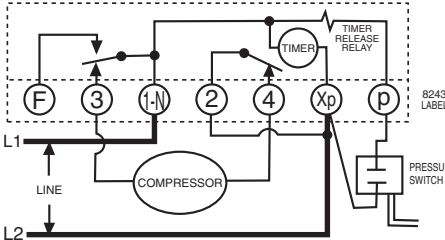

NOTE: Remove Bridge Between 1N–2
 *See Note 2

DTMV40 Time/Pressure–Electric Defrost Wiring Diagram
12 8247 Replacement–Double Pole Switching
 Mode B with 8247 Label Applied

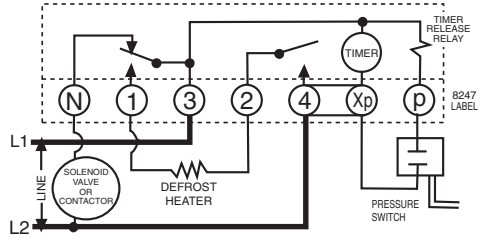

NOTE: Remove Bridge Between 3–4
 Connect Bridge Between 4–Xp

WIRING LEGENDS

Paragon Model	Precision Model	GRASSLIN Model	S1 Mode Selector	Terminal Ident. Label	Typical Wiring Diagram	Terminal Layout (see note below)
TIME INITIATED, TIME TERMINATED						
8045 8046	6045	DTMV40 DTMV40	A A	None None	1	
8041	6041	DTMV40	A	8041	2	
8043	6043	DTMV40	B	8043	3	
8047	6047	DTMV40	B	8047	4	
TIME INITIATED, REMOTE TEMPERATURE OR PRESSURE TERMINATED						
8145	6145	DTMV40	A	None	5, 6	
8141	6141	DTMV40	A	8141	7	
8143	6143	DTMV40	B	8143	8, 9 See Note 1	
TIME INITIATED, PRESSURE TERMINATED (Separate Pressure Switch Required - see instructions)						
8245	6245	DTMV40	A	8245	10	
8243	6243	DTMV40	B	8243	11 See Note 2	
8247	6247	DTMV40	B	8247	12	

NOTE: In "Terminal Layout," the connecting lines between terminals indicate the correct positions of the bridges for each model. The heavy line indicates the bridge must be installed as shown. The light line indicates the bridge may be removed if different voltages are used at each switch.

APPLICATION

The DTMV40 Defrost Timer is equivalent in function, terminal identification, and wiring to the Paragon 8140 and Precision 6140 series Defrost Timers. The DTMV40 may also be used to replace Paragon 8040 and Precision 6040 series time terminated defrost timers. With the addition of a remote pressure switch, the DTMV40 can replace the Paragon 8240 series and Precision 6240 series pressure terminated defrost timers. Defrosts will be initiated by programming the timer, which will accept from 1 to over 24 defrost initiation settings per day at 15 minute intervals (8:00AM, 8:15AM, 8:30AM, etc.) *Defrost duration* is settable in 15 minute intervals from a minimum of 15 minutes up to several hours (15 minutes, 30 minutes, 45 minutes, 1 hour, 1 hour-15 minutes, etc.) The *defrost duration* determines the *termination time*.

In standard configuration, the contacts between terminals 1 and 3 are normally open and close during a defrost to energize defrost heaters; the contacts between terminals 2 and 4 are normally closed (when timer is energized) and open during a defrost to de-energize refrigeration and fans.

DTMV40 Time Initiated, Remote Temperature, Pressure or Time Terminated:

Used in electric or hot gas defrost applications where the defrost is terminated when the coil is frost free, as sensed by a temperature or pressure switch, even

though the defrost programmed *termination time* has not been reached. The *time termination* functions as a fail-safe and will terminate the defrost if the temperature or pressure switch fails to do so. The temperature or pressure switch on the refrigeration coil has contacts which close on a temperature or pressure rise above freezing, indicating that frost and ice have melted from the coil. Typically a wide differential SPDT temperature switch is used with its normally closed contacts wired to the fans thereby delaying the fans from coming on until the coil temperature has dropped back to below freezing. In most applications, the contacts at terminals 2 and 4 are normally closed (when timer is energized) and control the fans and refrigeration equipment or compressor. For hot gas defrost, or for double pole switching, contacts 2 and 4 may be configured as normally open by selecting mode "B." Refer to wiring diagrams 1 thru 12 for additional detail.

"F" Terminal:

The DTMV40 contains a normally closed contact between terminals 1 and F. This terminal may be used to switch the fans off during a defrost rather than terminals 2 and 4. For hot gas defrost applications, with the mode switch set to position "B", the fans may be connected to terminal "F."

Note: The DTMV40 is configured by default (out of the box) to replicate the 8145 wiring. For replacement of other models refer to page 3.

REPLACING EXISTING DEFROST TIMERS

IMPORTANT:

When replacing a Grasslin DT-040 model with a DTMV40, the power connections must be made to terminals **N** and **1** on the DTMV40. No connection must be made to the **X** terminal or damage to the unit will result. Disconnect the power wire from terminal **X** on the DT-040 and connect it to terminal **N** on the DTMV40. Disconnect the other power wire from terminal **N** on the DT-040 and connect it to terminal **1** on the DTMV40. All other wires should be connected to the DTMV40 the same as on the DT-040.

The DTMV40 will replace all models of Paragon 8040, 8140, 8240 Series or Precision 6040, 6140, 6240 Series.

TERMINAL IDENTIFICATION:

The standard DTMV40 terminal identification is identical to the Paragon 8145 with the addition of the "F" terminal. Terminal identification labels are provided for the other models to be placed over the printed numbers on the printed circuit board. From the table on page 4, select the proper label, apply to printed circuit board, and wire per the original wiring or the wiring diagrams indicated.

MODE SELECTION (Light Blue DIP Switch):

First determine what model is being replaced (Grasslin or Competitors). The mode selector DIP switch (located at lower right side of the board) determines the configuration of terminals 2&4. In position "A", the terminals are normally closed (only when the timer is energized), and will open during a defrost. In position "B", terminals 2&4 are normally open, and will close during a defrost. Select proper position from table below and wiring diagrams indicated. To select mode simply slide the switch as follows:

Mode **A** – position switch to left; Mode **B** – position switch to right

Note: When Mode "B" is selected the DTMV40 will operate as follows:

Refrigeration Mode – RED & GREEN LED's will turn OFF (1&3 and 2&4 break while 1&F make)

Defrost Mode – RED & GREEN LED's will turn ON (1&3 and 2&4 make while 1&F break)



8045 REPLACEMENT:

The DTMV40 with 8045 terminal ID label applied differs from the 8045 in that terminals **1** and **N** are combined. This means that the DTMV40 model must be the same voltage as the defrost circuit (defrost heater, contactor coil, or hot gas valve). If used in an application where the defrost circuit is 120V and the refrigeration circuit is 240V,

the DTMV40 must be configured for 120V application (RED DIP Switch Down) with 120V power connected to **1-N** and **X**, and the bridge jumper between **1-N** and **2** must be removed.

Note 1 – (8143 Replacement): When replacing a Paragon 8143 or Precision 6143, wire the termination thermostat to terminal **N** of the DTMV40 and the adjacent blank terminal. The Paragon and Precision timers are wired to terminal **N** and the blank terminal. If the termination thermostat is wired to terminal **N** of the DTMV40 (with the 8143 label attached), temperature termination will not occur and may result in burnout of the DTMV40. See wiring diagrams 8 & 9.

8240/6240 SERIES REPLACEMENT: The DTMV40 may be used to replace the Paragon 8240 or Precision 6240 series defrost timers with integral pressure termination by the addition of a remote pressure switch wired to terminals **Xp** and **p** of the DTMV40 (with an 8240 series terminal label applied). There must be no external voltage connected to the pressure switch. Set pressure switch cut-in to the same value as set on the Paragon or Precision defrost timer being replaced. Set cut-out 6 to 14psi below cut-in. See wiring diagrams 10, 11, and 12.

Recommended Pressure Switches: Johnson/Penn P170, Ranco 010 series, or Danfoss KP1 series. Pressure range approximately 35-110psi, CUT-IN ON PRESSURE RISE.

NOTE 2 – (8243 Replacement): When replacing a Paragon 8243 or Precision 6243, the DTMV40 white tabs (trippers) for setting defrost time and defrost duration must be reversed. Pull ALL tabs outward for refrigeration. Press the tabs inward at the desired defrost initiation times, and for desired duration.

Please Note: The DTMV40 replaces all prior Grasslin defrost timer models such as DT040, DT140, DTMV, and DTSX.

SPECIFICATIONS

Switch Rating:

40A Resistive @ 120VAC, 208-240VAC

2HP @ 208-240VAC; 1HP @ 120VAC

16FLA, 90LRA @ 120VAC

12FLA, 52LRA @ 240VAC

"F" Terminal: 30A Resistive @ 120-240VAC

1HP @ 120VAC; 2HP @ 208-240VAC

Wiring Connections: Screw box lug terminals.

Environmental Ratings:

Operating Temperature Range: -40°F to 131°F (-40°C to 55°C)

Operating Humidity: 0 to 95% non-condensing

Dimensions: 8.795" x 6.631" x 2.935" (H x W x D)

Shipping Weight: 2 lbs.

DTMV40 INSTALLATION INTO EXISTING ENCLOSURE

SETUP PROCEDURE

1. Disconnect power.
2. Disconnect wiring from existing defrost timer.
3. Remove Paragon mechanism from enclosure.
4. Remove Grasslin DTMV40 printed circuit board from its enclosure (gray plastic).
5. If necessary, adjust DIP switches and apply terminal identification label as indicated in the DTMV40 operating instructions.
6. Engage tabs on left side of printed circuit board into enclosure, and swing PCB into place.
7. Apply extra DTMV40 label to existing enclosure door.
8. Reconnect wires to DTMV40.
9. Attach gray faceplate over PCB and secure using existing enclosure locking latch as illustrated.
10. Reapply power.



DTMV40 Installation into Old Paragon Enclosure/Bracket

*****Note: Grasslin Recommends replacing Old Paragon Enclosure/Bracket entirely with the DTMV40 NEMA3R Enclosure or DTMV40-B Bracket Mount *****

SETUP PROCEDURE

1. Disconnect power (turn breaker OFF).
2. Disconnect wiring from existing Paragon timer.
3. Remove and save the 6-32 screw. Remove and discard two metal posts retaining Paragon mechanism.
4. Remove Paragon mechanism from enclosure.
5. Remove Grasslin DTMV40 mechanism from it's enclosure (if applicable) and with pliers break off the 3 tabs on left side of printed circuit board.
6. Remove contents of plastic hardware bag.
7. Refer to DTMV40 operating instructions for procedures on setting voltage and mode DIP switches.
8. Refer to installation diagram below. **CAUTION: If the DTMV40 mechanism is not assembled to the old Paragon enclosure/bracket exactly as shown below, a short circuit may occur which will destroy the DTMV40 defrost timer.**
9. Reconnect wires, tighten terminal screws securely. Reapply power (turn breaker ON).
10. Follow the programming/setup procedure (refer to DTMV40 operating instructions).

Old Paragon Enclosure

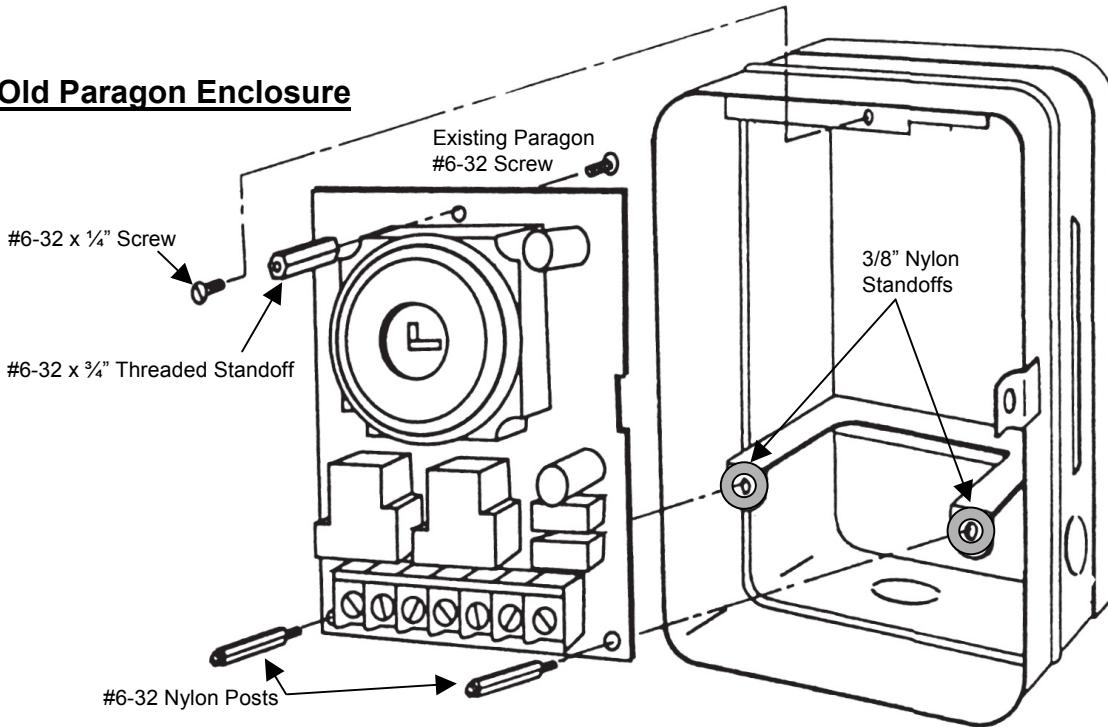

Paragon Bracket

